

WIRE TWISTERS & WIRE/PIN/ROD CUTTERS

Our wire twisters and wire/pin/rod cutters are engineered for strength, control, and durability. Designed to handle surgical wires and fixation devices with precision, these instruments ensure secure twisting and clean cuts without damaging surrounding tissue. Made from high-grade surgical steel, they offer excellent grip, corrosion resistance, and long-term performance in demanding orthopedic procedures.



WIRE TWISTERS

LOUTIE WIRE TIGHTENER

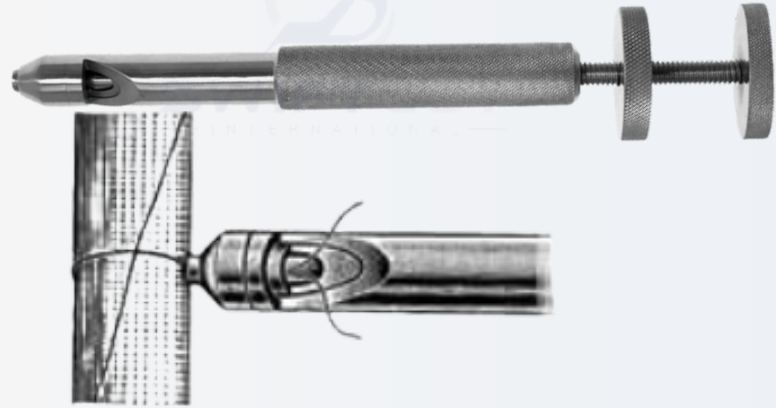

CODE #	DESCRIPTION
SC46619	Maximum capacity 1.5 mm or 17 gauge cerclage wire, 8-1/2" (21.5 cm)

CORWIN WIRE TWISTER



CODE #	DESCRIPTION
SC46582	6-1/4" (16 cm) with carbide inserts Maximum capacity 0.8 mm or 21 gauge cerclage wire

WIRE TWISTING FORCEPS

Carbide Inside

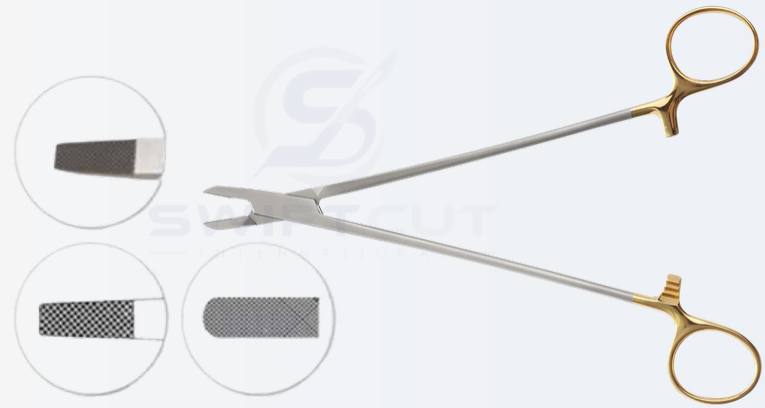

CODE #	DESCRIPTION
SC48320	6" (15 cm), TC
SC48322	4 mm tip, 8" (21 cm), TC
SC48324	6 mm tip, 7-1/4" (19 cm), TC

JET WIRE TWISTER

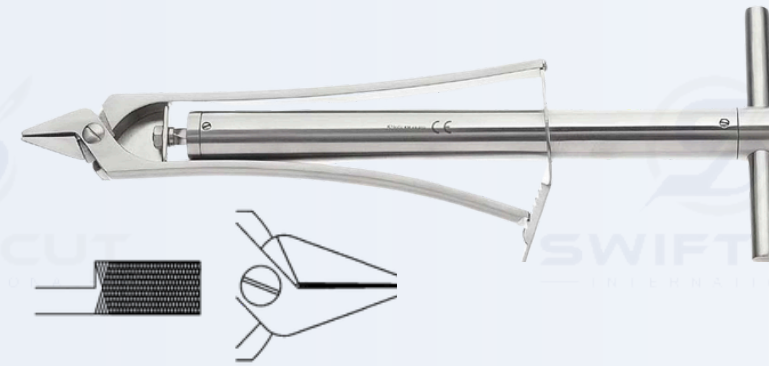

CODE #	DESCRIPTION
SC49810	11" (28 cm) 10 mm tip

WIRE PULLING FORCEPS

Facilitates holding and pulling of pins and wires.

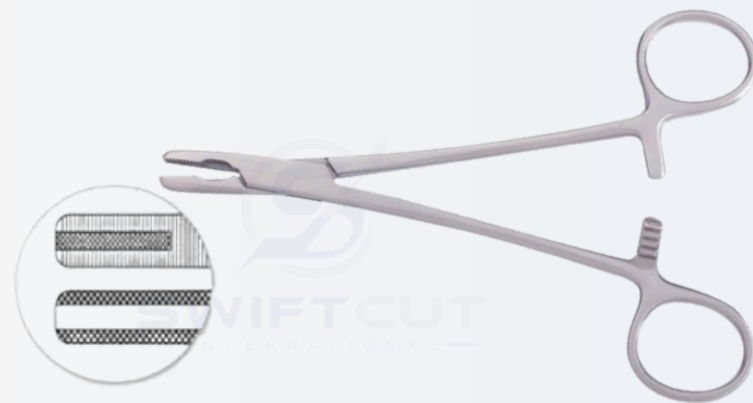

CODE #	DESCRIPTION
SC46637	Maximum capacity 1 mm, 6-1/2" (17 cm)

P.I. WIRE TWISTER AND TIGHTENER



CODE #	DESCRIPTION
SC69846	6-1/4" (16 cm)

DELICATE WIRE CUTTER

Delicate side-cutting jaws with carbide inserts.
Especially useful for pediatric, foot and hand surgery

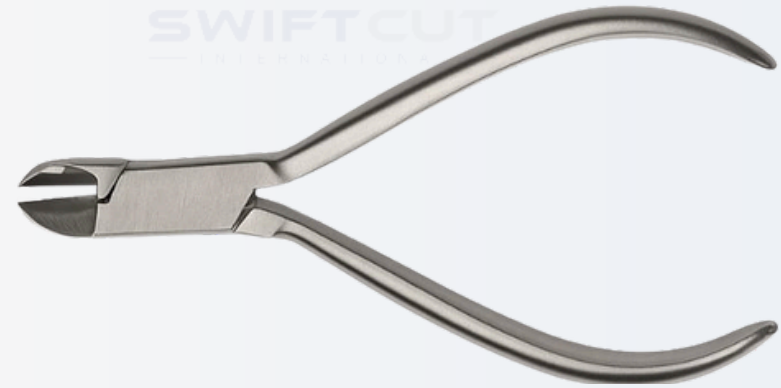

CODE #	DESCRIPTION
SC46622	Side cutting with carbide inserts, maximum capacity 0.028" (0.7 mm), 4-7/8" (12.5 cm)

WIRE CUTTERS

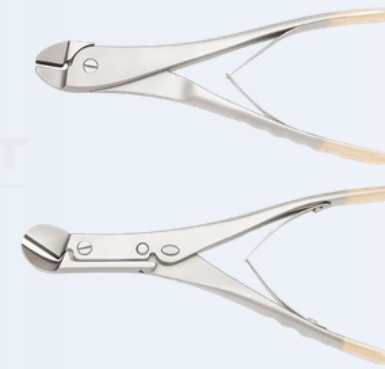

CODE #	DESCRIPTION
142519	Single action, 7-7/8" (20 cm), TC
142520	Angled jaw, double action, 8-1/2" (21.5 cm), TC

STAINLESS STEEL WIRE CUTTING FORCEPS



CODE #	DESCRIPTION
142550	142550 6-7/8" (17.5 cm)

SIDE CUTTER



CODE #	DESCRIPTION
SC46621	Side cutting, welded carbide jaws, maximum capacity 0.062" (1.6 mm), 7-1/4" (18.5 cm)

SIDE CUTTER

Welded carbide jaws.



CODE #	DESCRIPTION
SC49736	Maximum capacity 3/32" (2.4 mm), 9" (23 cm)

K-WIRE SIDE CUTTER

Welded hardened jaws

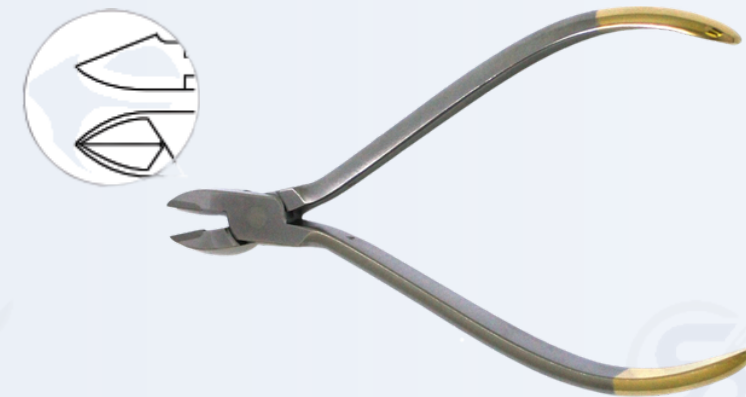

CODE #	DESCRIPTION
SC49734	Maximum capacity 0.045" (1.1 mm), 6" (15 cm)

WIRE CUTTER WITH SAFETY INSERTS

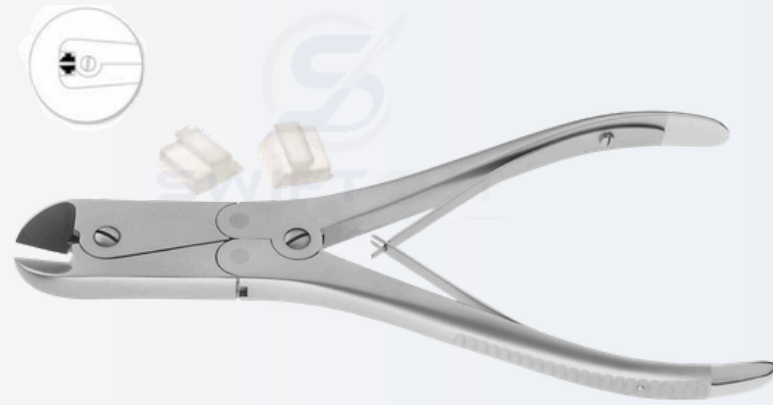

CODE #	DESCRIPTION
SC49740	Maximum capacity 0.062" (1.6 mm), 6-7/8" (17.5 cm)
SC49740P	Set of replacement silicon inserts

DOUBLE ACTION WIRE CUTTERS

Narrow jaw makes this cutter a favorite with hand and foot surgeons.



CODE #	DESCRIPTION
SC46623	Angled, side cutting with carbide inserts, maximum capacity 0.062" (1.6 mm), 6-5/8" (17 cm)
SC46624	Angled, side cutting with carbide inserts, maximum capacity 3/32" (2.4 mm), 8-1/2" (21.5 cm)

FRONT AND SIDE WIRE CUTTER

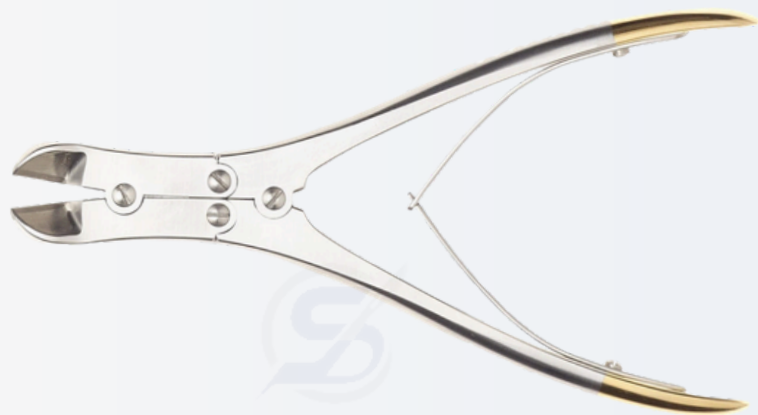

CODE #	DESCRIPTION
SC46625	Front and side cutting with carbide inserts, double action, maximum capacity 0.062" (1.6 mm), 6-3/4" (17 cm)

FLUSH WIRE CUTTER

This improved version of our Front and Side Cutter cuts flush to the bone like no other wire cutter. This is a big advantage in buried wire procedures.

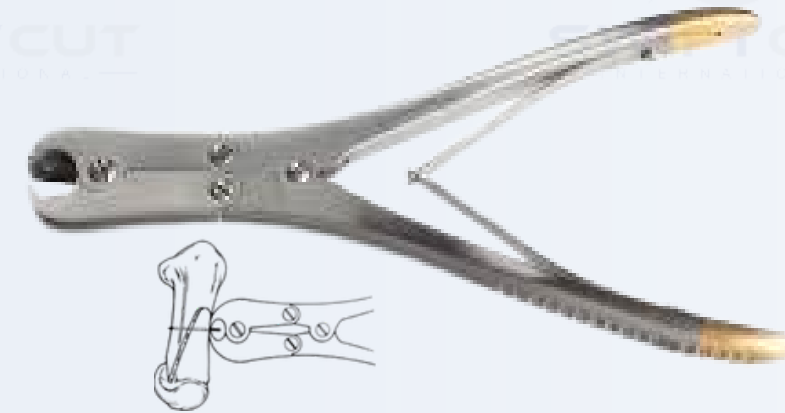

Code #	DESCRIPTION
SC46631	Front and side cutting with carbide inserts, double action, maximum capacity 0.059" (1.5 mm), 6-3/4" (17 cm)

K-WIRE END CUTTER



CODE #	DESCRIPTION
SC49735	Maximum capacity 0.045" (1.1 mm), 5-1/2" (14 cm)

END CUTTER

Welded carbide jaws.

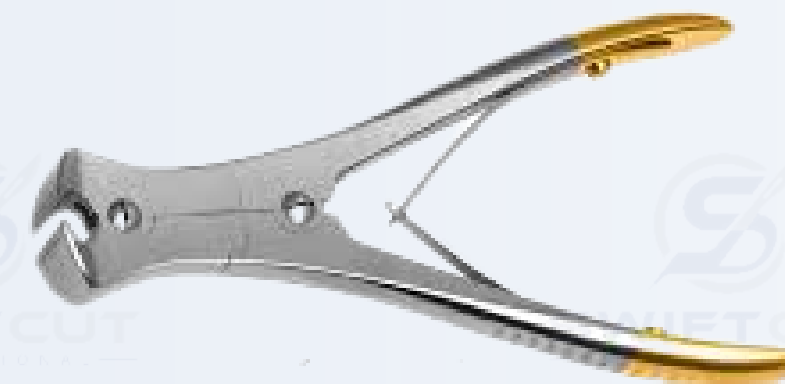

CODE #	DESCRIPTION
SC49738	Maximum capacity 3/32" (2.4 mm), 8-1/2" (21.5 cm)

PIN CUTTERS

CANNULATED PIN CUTTER

Cannulation allows you to slide the cutter over the inserted wire. The pie



CODE #	DESCRIPTION
SC46647	End cutting, maximum capacity 0.062 (1.6 mm), 7-1/4" (18.5 cm)

END CUTTER



CODE #	DESCRIPTION
SC46651	End cutting, welded carbide jaws, maximum capacity 0.062" (1.6 mm), 5-3/4" (14.5 cm)

DIAMOND PIN CUTTER

Disassembles easily for cleaning.



CODE #	DESCRIPTION
SC46649	End cutting, maximum capacity 5/64" (2 mm), 6-3/8" (16 cm)

DOUBLE ACTION PIN CUTTER

Double action handles give more power to cut pins up to 1/8" (3.2 mm). Side cutting.



CODE #	DESCRIPTION
SC49800	Maximum capacity 1/8" (3.2 mm), 9-1/2" (24 cm)

MEDIUM PIN CUTTER

Heavy duty cutters with replaceable jaws.

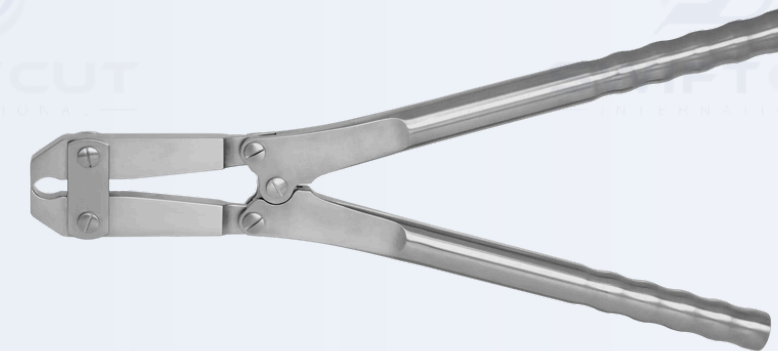

CODE #	DESCRIPTION
SC46633	Maximum capacity 3/16" (4.7 mm), 14-3/8" (36.5 cm)

SMALL PIN CUTTER



CODE #	DESCRIPTION
SC46632	Maximum capacity 1/8" (3.2 mm), 10-1/4" (26 cm)

PLATE CUTTING FORCEPS

For cutting stainless steel mini plates up to 1 mm.

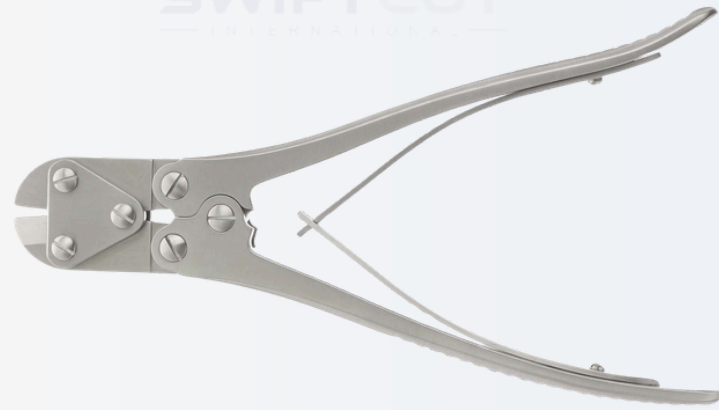

CODE #	DESCRIPTION
SC47932	Straight, 9-1/4" (24 cm)

SIDE PIN CUTTER

Heavy duty cutter for rods up to 4 mm and heavy Steinmann pins. Slightly angled jaws house long-lasting special carbide insert for cutting hard titanium and stainless steel rods.



CODE #	DESCRIPTION
SC46629	Side cutting with carbide inserts, maximum capacity 5/32" (4 mm), 15" (38 cm)

LARGE PIN CUTTER

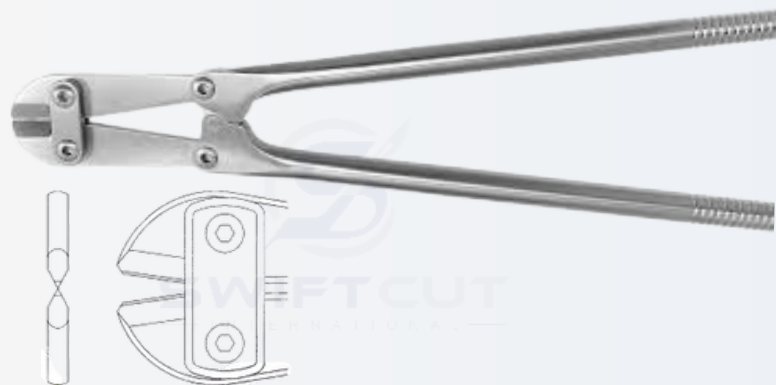

CODE #	DESCRIPTION
SC46626	22-5/8" (57.5 cm) Maximum capacity 1/4" (6.3 mm)

CABLE CUTTER

Cuts cleanly through cables without fraying

Small jaw design enables surgeon to get close to bone – even in tight spaces.

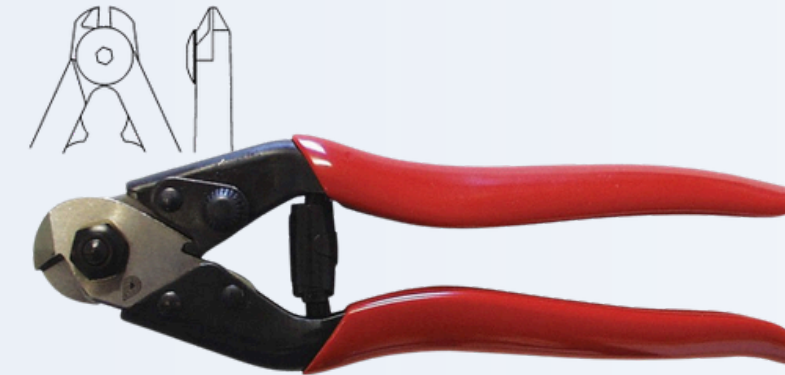

CODE #	DESCRIPTION
SC48378	7" (18 cm) Maximum capacity 2.0 mm Cable jaws can be resharpened and replaced

NOTE: This instrument should only be used for cutting cable. Lubricate joint to ensure proper function.

ROD CUTTERS

HAND-HELD ROD CUTTER

All of the benefits of the table top cutter in a hand-held model. Cuts rods from 4.76 mm 3/16" to 6.35 mm (1/4")

IMPORTANT: This large cutter is not designed to be used inside the patient's body.

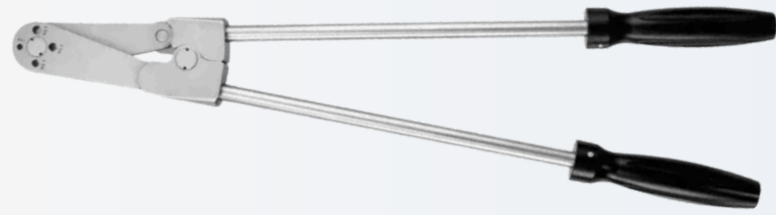

CODE #	DESCRIPTION
SC46635	Stainless steel with silicone handle, 27" (68.5 cm)

TABLE TOP ROD CUTTER

Provides an easy and safe way to cut spinal rods



CODE #	DESCRIPTION
SC46628	TABLE TOP ROD CUTTER SC46628 27-1/2" (70 cm) Cuts rods from 4.76 mm (3/16") to 6.35 mm (1/4")

