

Laparoscopic Instruments Catalogue 2026

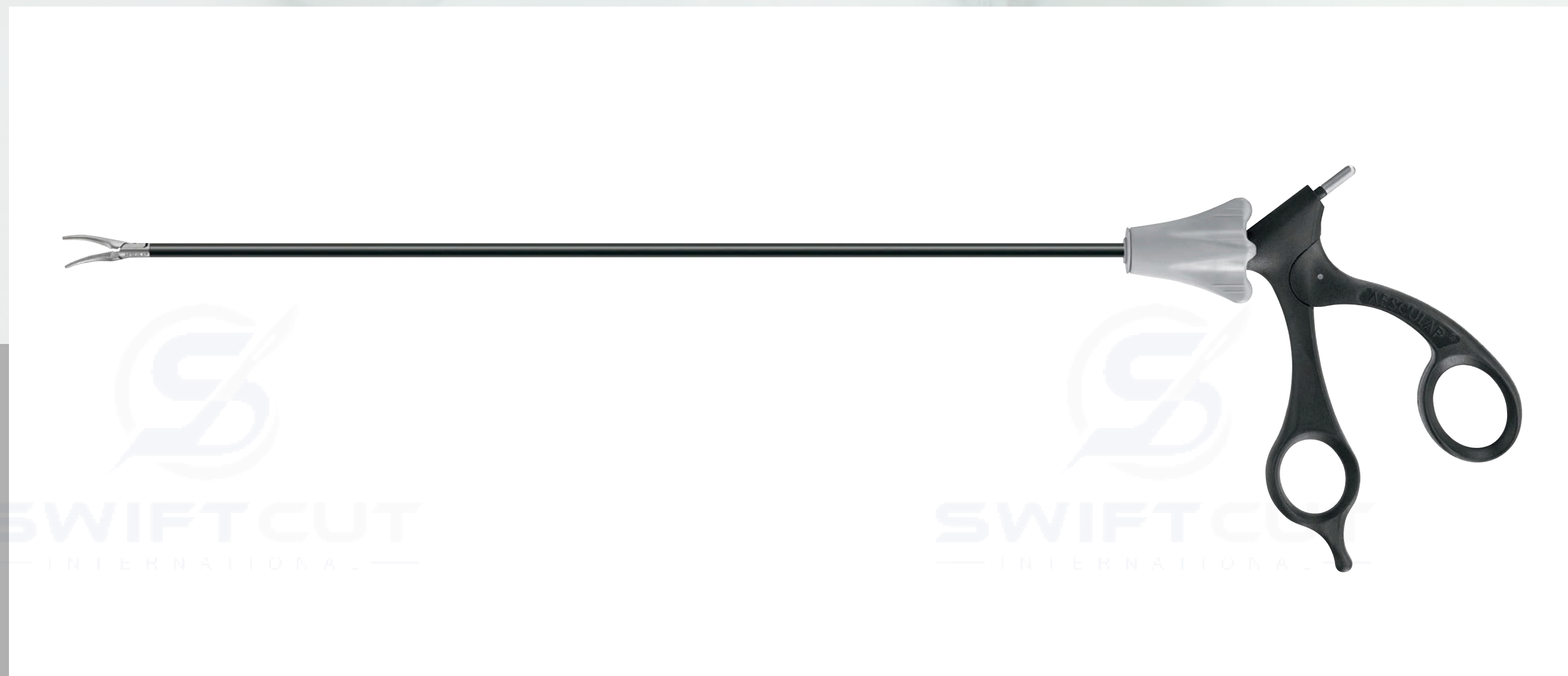

INDEX CATALOGUE 2026

SWIFTCUT
INTERNATIONAL

SWIFTCUT
INTERNATIONAL

SWIFTCUT
INTERNATIONAL

SWIFTCUT
INTERNATIONAL

SWIFTCUT
INTERNATIONAL

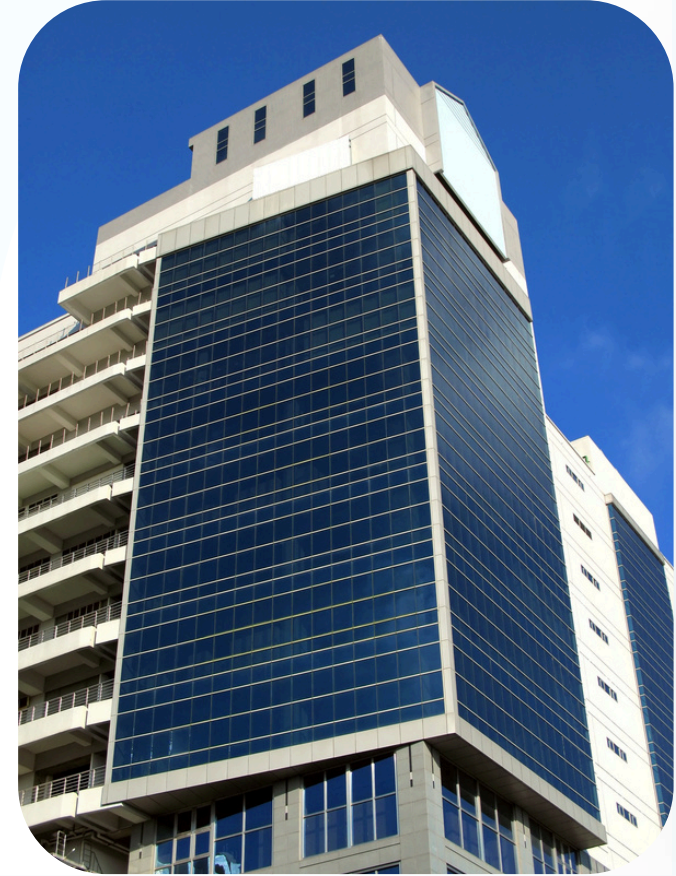

01-12
COMPANY



13-14
WHY SWIFTCUT
INTERNATIONAL



15-62
MONOPOLAR
INSTRUMENTS



63-66
BIPOLAR
INSTRUMENTS

SWIFTCUT
INTERNATIONAL

SWIFTCUT
INTERNATIONAL

SWIFTCUT
INTERNATIONAL

SWIFTCUT
INTERNATIONAL

SWIFTCUT
INTERNATIONAL



67-78
Speciality
instruments



79-82
Ligation
Instruments



83-92
ACCESS &
CLOSURE



93
CONTACT US

SWIFTCUT
INTERNATIONAL

SWIFTCUT
INTERNATIONAL

SWIFTCUT
INTERNATIONAL

SWIFTCUT
INTERNATIONAL

SWIFTCUT
INTERNATIONAL

WWW.SWIFTCUTINT.COM

Welcome to SWIFTCUT INTERNATIONAL

Since 2019

Established in 2019 and based in Sialkot, Pakistan, the global hub for surgical and dental instruments manufacturing, Swiftcut International is dedicated exclusively to producing high-quality surgical instruments. With a focus on precision, durability, and compliance with international standards, we proudly serve clients worldwide through efficient production, strict quality control, and reliable global distribution.



Our Mission and Values



Quality Care

We are committed to delivering premium surgical instruments that enhance clinical performance and patient outcomes, ensuring precision, safety, and long-term reliability.



Integrity and Trust

Every partnership is built on transparency, ethical practices, and consistent quality, earning the trust of surgical professionals across the globe., using the best corporate policies to mitigate risks to uphold client confidence.



Sustainability

We embrace responsible manufacturing by minimizing waste, using eco-conscious materials, and continuously improving processes to reduce our environmental footprint.

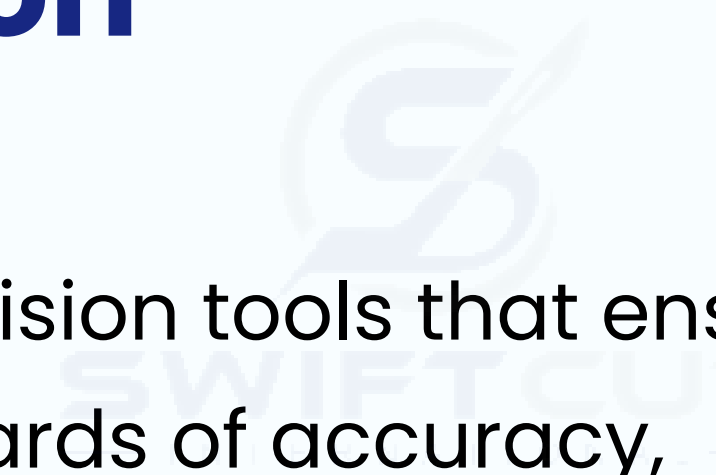
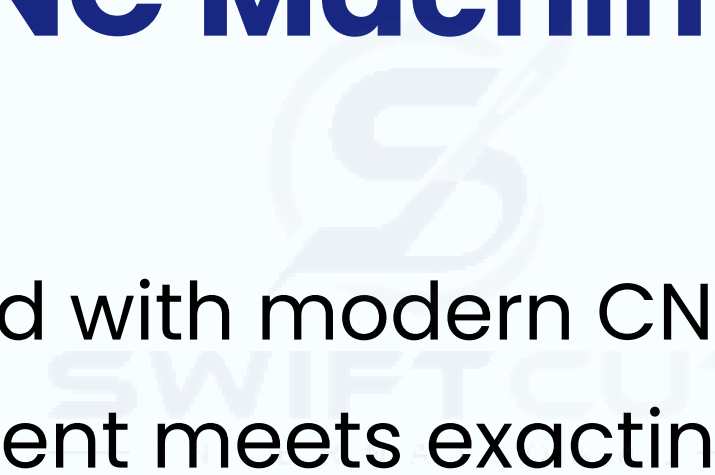

State-of-the-Art Production

Advanced CNC Machining & Precision Engineering

Our facility is equipped with modern CNC machines and precision tools that ensure each surgical instrument meets exacting international standards of accuracy, durability, and finish.

Strict Quality Control & Sterilization Protocols

Every instrument undergoes multi-stage inspections, surface treatment, and ISO-compliant sterilization processes, guaranteeing safety, consistency, and top-tier performance.

Compliance with Global Production Standards

We adhere to internationally recognized production certifications such as ISO 13485 and CE marking, ensuring our instruments meet regulatory, clinical, and safety standards required by surgical professionals worldwide.

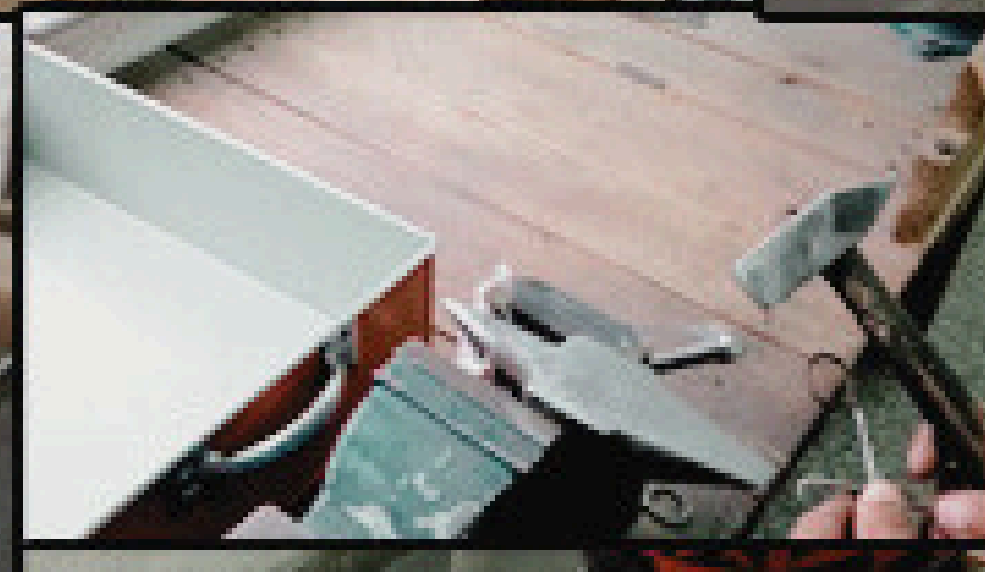
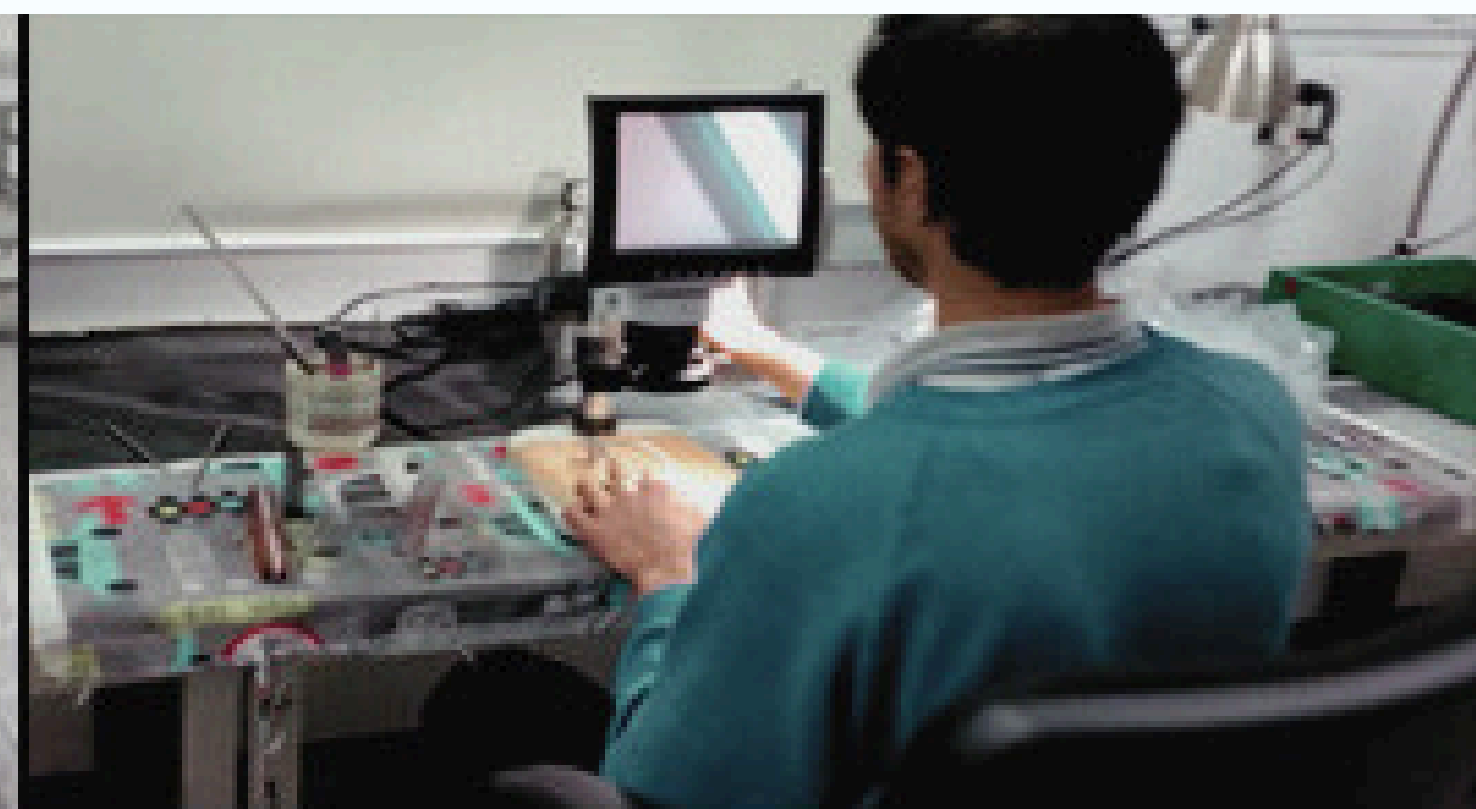
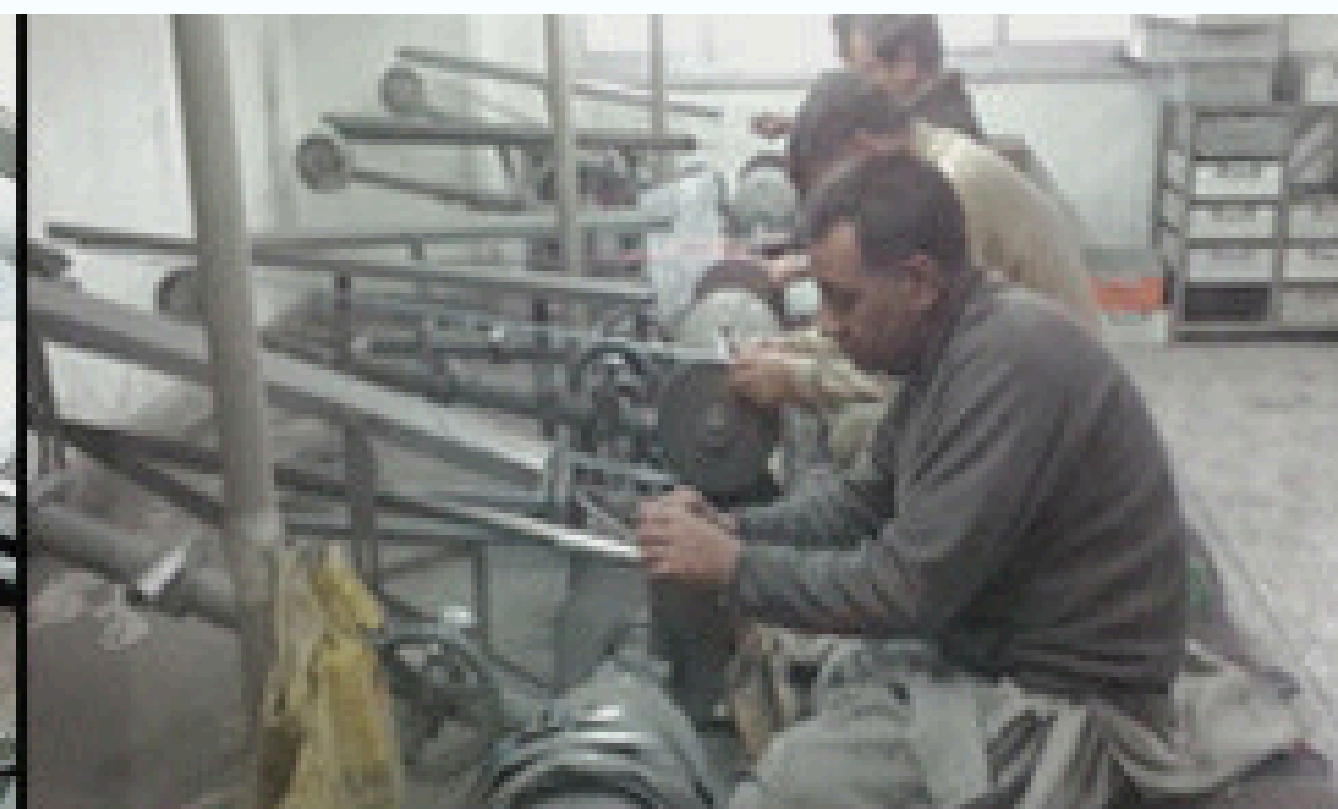
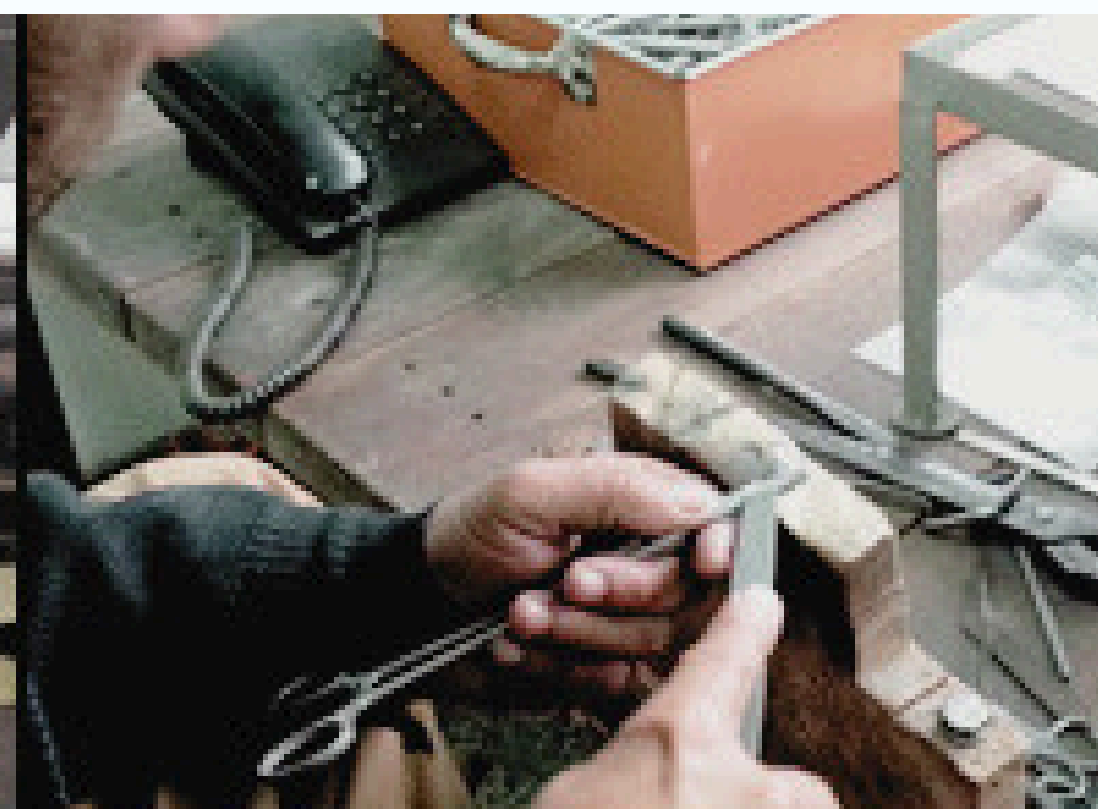

Worldwide Supply

At Swiftcut International, our reach extends far beyond borders. With a robust global supply network, we efficiently deliver premium-quality surgical instruments to clients across North America, Europe, the Middle East, Asia, and beyond. Our international logistics capabilities are supported by streamlined production planning, secure packaging standards, and reliable partnerships with freight and distribution companies.

We understand the diverse regulatory and compliance needs of different markets and ensure our products meet the certifications and documentation required for smooth cross-border transactions. Whether it's bulk shipments for distributors or tailored consignments for institutional buyers, we are committed to timely, safe, and consistent delivery.

Our dedicated export team manages each step with precision, providing responsive communication, real-time updates, and after sales support that reflects our promise of long-term collaboration. With Swiftcut International, clients around the world benefit from the reliability, responsiveness, and product excellence that define our international presence.

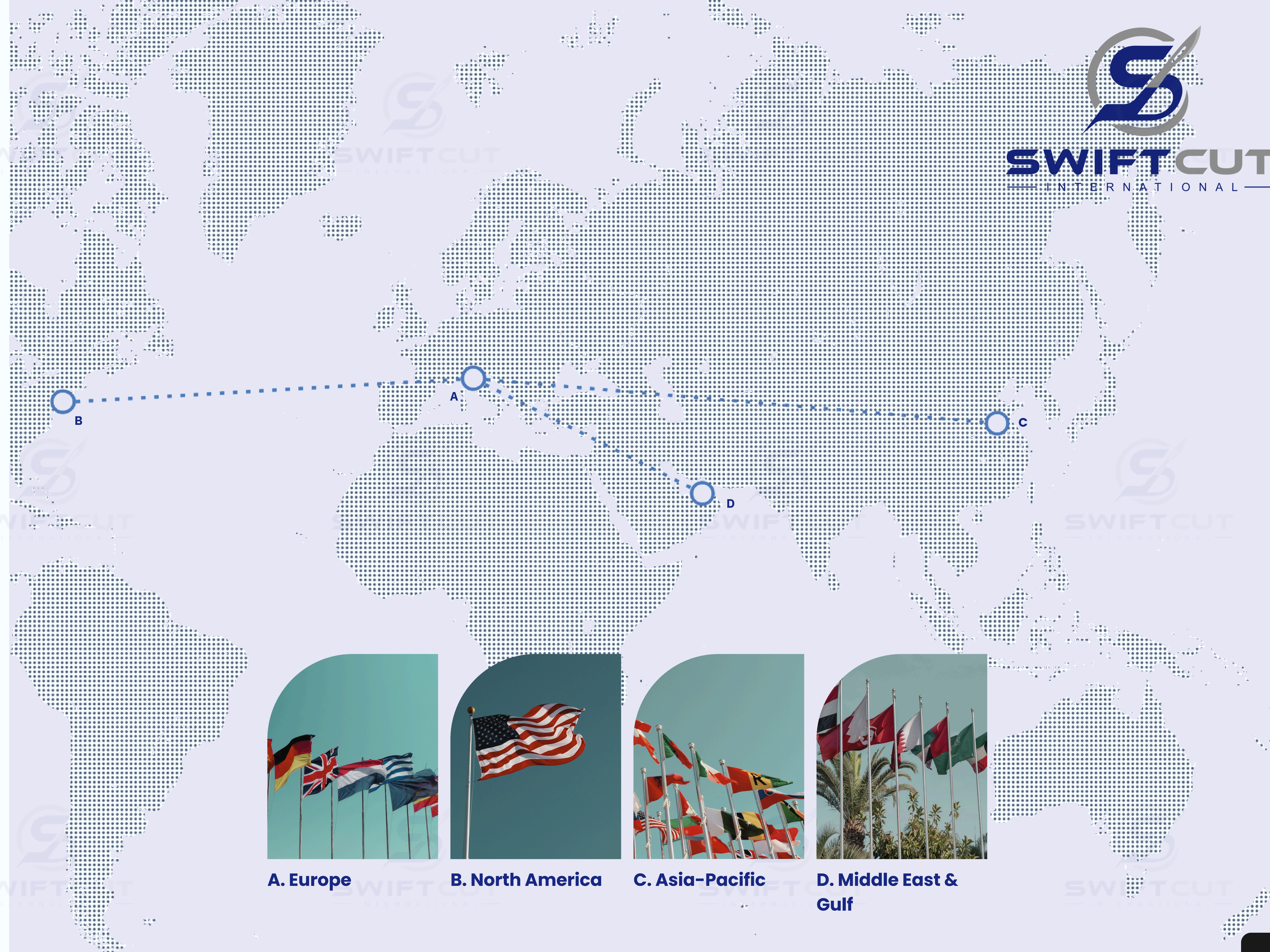

A. Europe



B. North America



C. Asia-Pacific



D. Middle East & Gulf



Advanced Digital Integration- Precision Instruments

SWIFTCUT INTERNATIONAL harnesses the latest digital technologies to deliver ultra-precise orthopedic instruments. Every tool is designed and manufactured using computer-aided design (CAD) and computer-aided manufacturing (CAM) workflows, ensuring exacting tolerances down to microns. Integrated quality control systems track each instrument through laser marking and RFID tagging, providing full traceability from production to end-use. Surgeons benefit from instruments whose digital origins guarantee repeatable accuracy, smoother handling and enhanced patient outcomes.

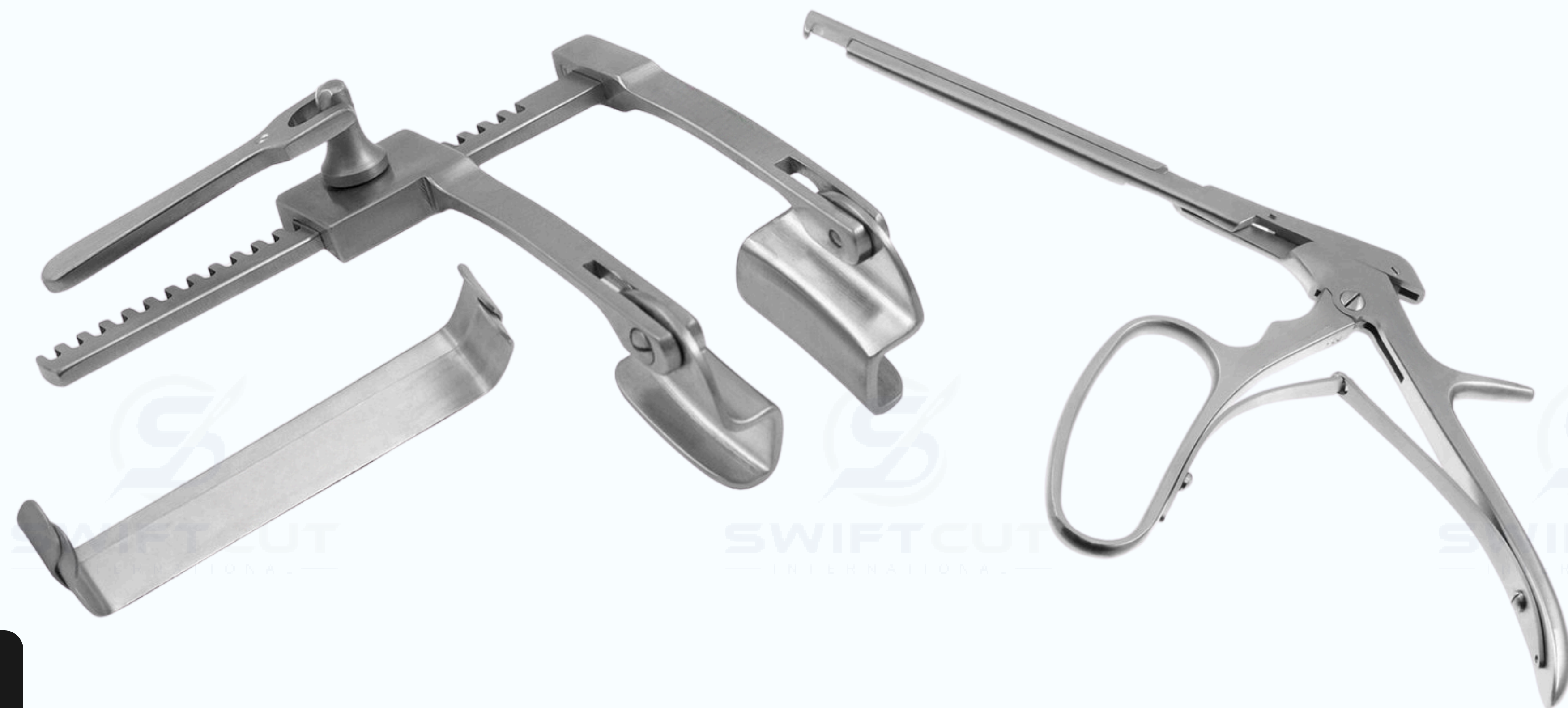

Corporate Social Responsibility

Fair Labour Practices

We are firmly committed to upholding fair labour standards across all areas of our business. This includes equitable compensation practices, transparent work contracts, reasonable working hours, and a safe, respectful, and inclusive environment where every individual is valued and protected.

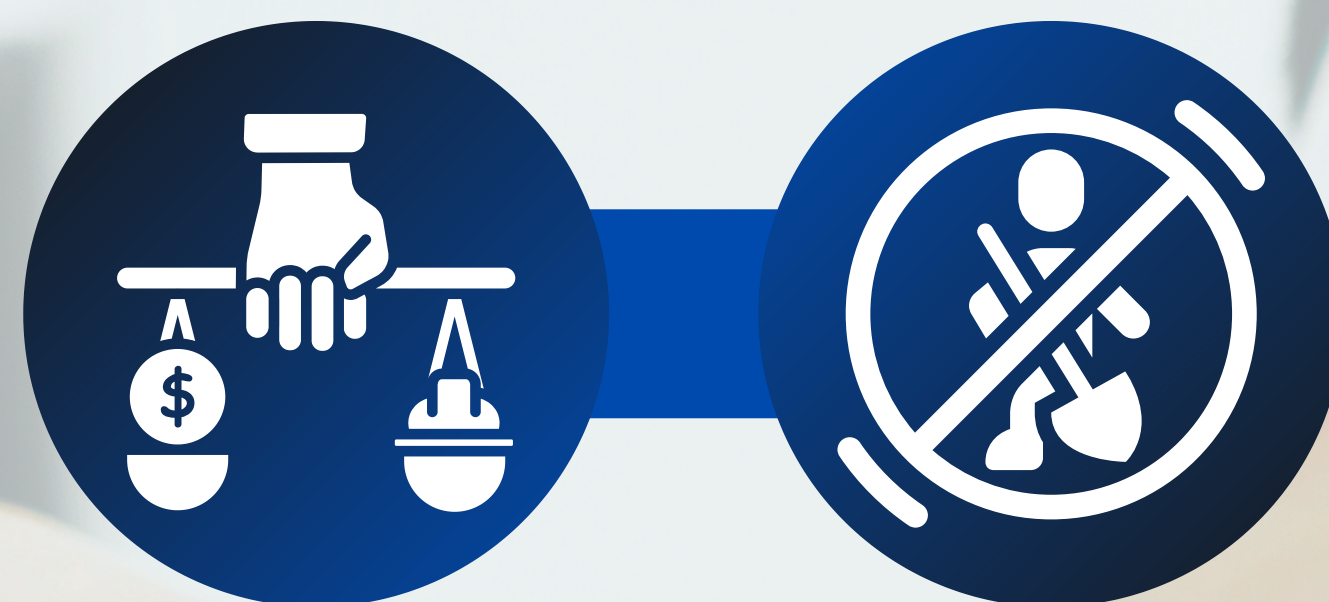

Equal Opportunity

We foster a workplace rooted in fairness and equality. All employment decisions, from recruitment to promotions are based on merit, experience, and potential, without discrimination on the basis of gender, race, religion, disability, or any other status protected by law.



Health & Safety

The health, safety, and well-being of our workforce are top priorities. We maintain robust safety systems, conduct routine training sessions, and actively monitor all work environments to prevent hazards, promote awareness, and ensure continual improvements in occupational health.



No Forced or Child Labour

Our operations and supply chain are governed by a zero tolerance policy for forced labour and child exploitation. We implement regular audits and due diligence practices to ensure that all our partners comply with international labour laws and ethical employment standards.

Freedom of Association

We recognize and respect every individual's legal right to join organizations, form unions, and participate in collective bargaining. We ensure an open environment where workers can express concerns or collaborate to improve working conditions without fear of retaliation or discrimination.

Grievance Mechanisms

We provide all employees with accessible, secure, and confidential channels to raise concerns, report misconduct, or suggest improvements. Every grievance is treated with urgency, impartiality, and discretion, with measures in place to protect whistle blowers from any form of reprisal.

WHY SWIFTCUT INTERNATIONAL

Premium Quality

Our Surgical instruments are manufactured with uncompromising precision using certified stainless steel and advanced CNC technology, delivering long-lasting performance, clinical accuracy, and professional-grade reliability, trusted by surgical instruments experts in practices and institutions worldwide.

Competitive Pricing

Our pricing model is designed to deliver maximum value without compromising on quality, offering cost-effective solutions through efficient production, bulk order benefits, and direct-from-manufacturer savings, empowering clients to stay competitive in every market.

Minimum Order Quantity

We support businesses of all sizes by offering low minimum order quantities, making it easier for startups, small clinics, and distributors to access premium surgical instruments without large upfront investments or inventory pressure.



Customized Solutions

We provide customized Surgical solutions including instrument modifications, private labelling, and branded packaging, designed to meet specific client needs and strengthen their identity in the market.

Customer Satisfaction

Customer satisfaction is at the heart of everything we do, driven by responsive support, consistent product quality, and on-time deliveries, building long-term trust and strong relationships with clients across the global surgical instruments industry.

Fast Turnaround Time

Our streamlined production process and efficient workflow enable us to offer fast turnaround times, ensuring that orders are manufactured, packed, and dispatched promptly to meet tight deadlines and urgent client needs without compromising on quality.

MONOPOLAR INSTRUMENTS

A versatile range of active electrodes and accessories for monopolar electrosurgery, enabling precise cutting and coagulation using high-frequency current. Includes reusable and disposable handpieces, blades, needles, ball electrodes, loops, and connecting cables. Designed for broad surgical application, these instruments provide efficient energy delivery, secure connections, and excellent surgeon control. High-grade insulation, ergonomic grips, and durable construction ensure consistent performance and patient safety.



Single Use Monopolar Instruments

mini 3.5 mm

Box of 5	Description	Item No.	Diam.	Length
	METZENBAUM Scissors	SC830SU	3.5 mm	29 cm



MARYLAND Dissecting forceps	SC831SU	3.5 mm	29 cm
-----------------------------	---------	--------	-------



Universal grasping forceps, fenestrated	SC833SU	3.5 mm	29 cm
---	---------	--------	-------



Single Use Monopolar Instruments

5 mm

Box of 5	Description	Item No.	Diam.	Length
	METZENBAUM Scissors	SC840SU	5 mm	31 cm

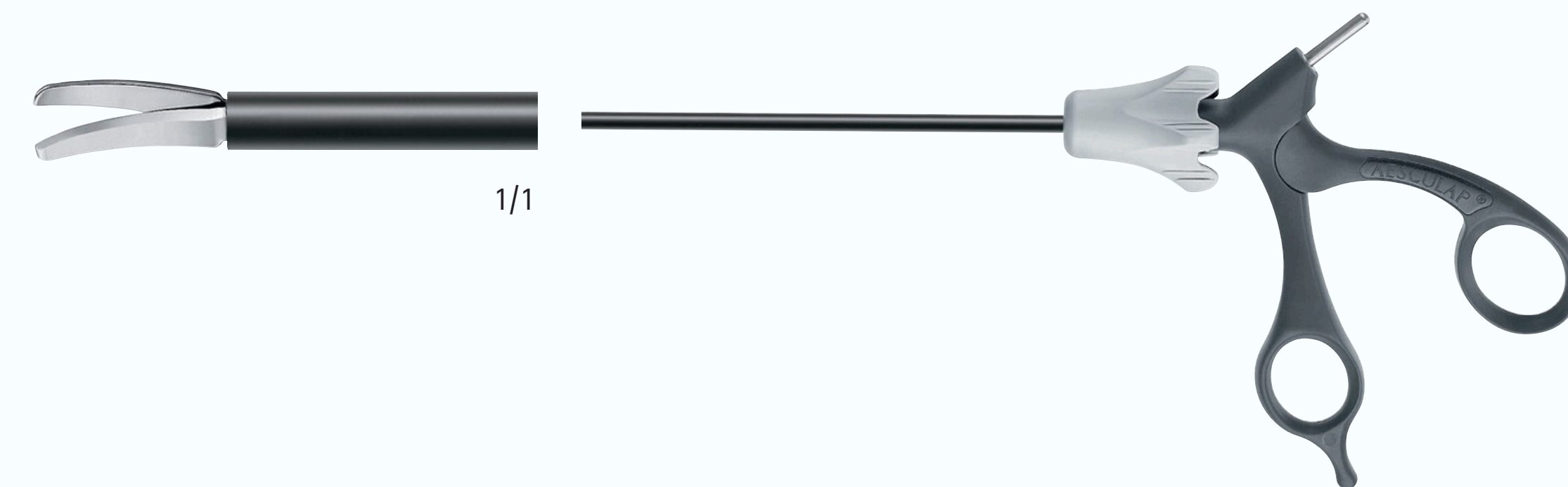

MARYLAND Dissecting forceps	SC841SU	5 mm	31 cm
-----------------------------	---------	------	-------

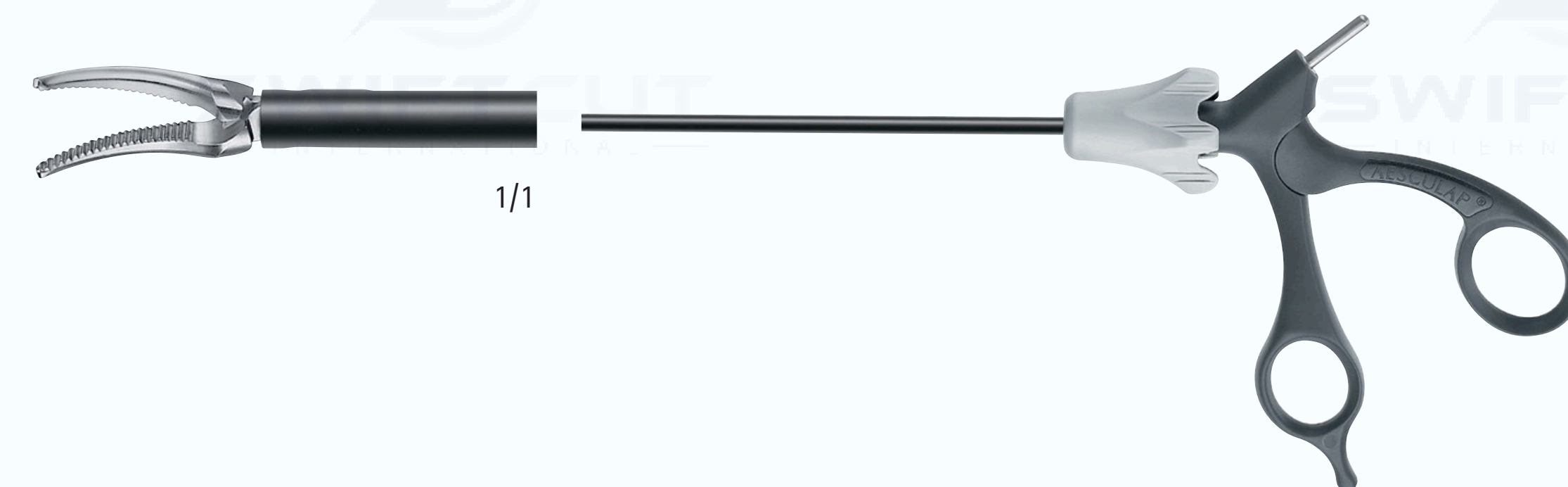

Pike mouth grasper	SC842SU	5 mm	31 cm
--------------------	---------	------	-------



Single Use Monopolar Instruments

mini 5.5 mm

Box of 5	Description	Item No.	Diam.	Length
	Universal grasping forceps, fenestrated	SC843SU	5 mm	31 cm



BABCOCK Grasping forceps	SC844SU	5 mm	31 cm
--------------------------	---------	------	-------



Reusable Monopolar Instruments

Scissors

Box of 10	Description	Item No.	Diam.	Length
	METZENBAUM Scissors, slightly curved	SC885SU	5 mm	31 cm

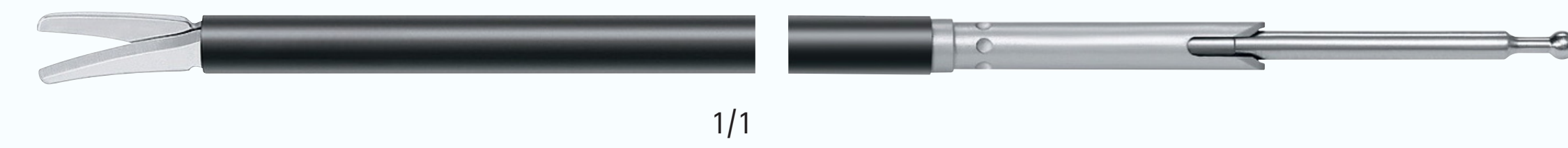

Hook scissors	SC886	5 mm	31 cm
---------------	-------	------	-------

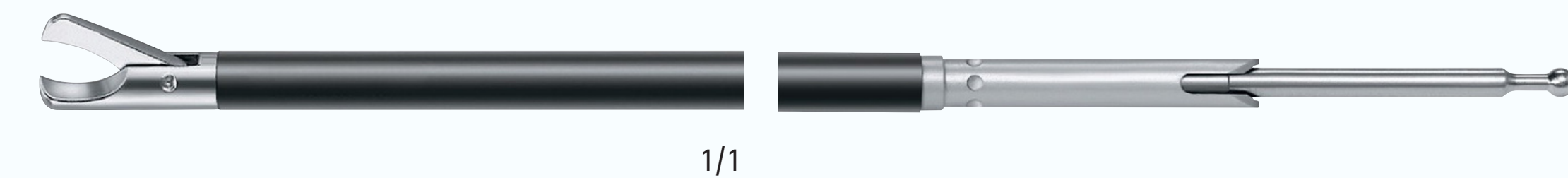

Mini METZENBAUM Scissors	SC887	5 mm	31 cm
--------------------------	-------	------	-------



METZENBAUM Scissors	SC888	5 mm	31 cm
---------------------	-------	------	-------

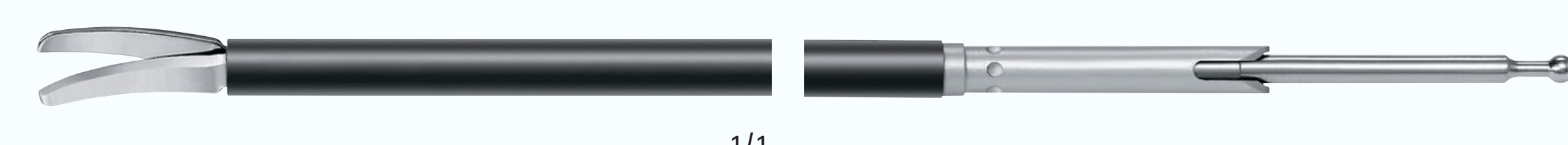

METZENBAUM Scissors	SC889	5 mm	42 cm
---------------------	-------	------	-------



Optional Handles – Interchangeable for 5 mm and 10 mm Instruments

SC958R (Quick-Snap™ Non-Ratchet)	SC959R (Quick-Snap™ Ratchet)	SC950R (Insulated Metal Non-Ratchet)	SC951R (Insulated Metal Ratchet)
-------------------------------------	---------------------------------	---	-------------------------------------



Dissecting & Grasping Forceps



Box of 10	Description	Item No.	Diam.	Length
	MARYLAND Dissecting forceps	SC891SU	5 mm	31 cm
	 Pike mouth grasper	SC892SU	5 mm	31 cm
	 Universal grasping forceps, fenestrated	SC893SU	5 mm	31 cm
	 BABCOCK Grasping forceps	SC894SU	5 mm	31 cm

Optional Handles - Interchangeable for 5 mm and 10 mm Instruments

SC958R (Quick-Snap™ Non-Ratchet)	SC959R (Quick-Snap™ Ratchet)	SC950R (Insulated Metal Non-Ratchet)	SC951R (Insulated Metal Ratchet)
			

Reusable Monopolar Instruments

mini 3.5 mm

		Complete Instrument			
Description	Item No.	Diam.	Length		
 METZENBAUM Scissors	SC300R	3.5 mm	29 cm		
	SC320R	3.5 mm	20 cm		
 Hook scissors	SC301R	3.5 mm	29 cm		
	SC321R	3.5 mm	20 cm		
 MARYLAND Dissecting forceps	SC302R	3.5 mm	29 cm		
	SC322R	3.5 mm	20 cm		
 Atraumatic dissection forceps	SC303R	3.5 mm	29 cm		
	SC323R	3.5 mm	20 cm		
 Pyloric spreader	SC304R	3.5 mm	29 cm		
	SC324R	3.5 mm	20 cm		

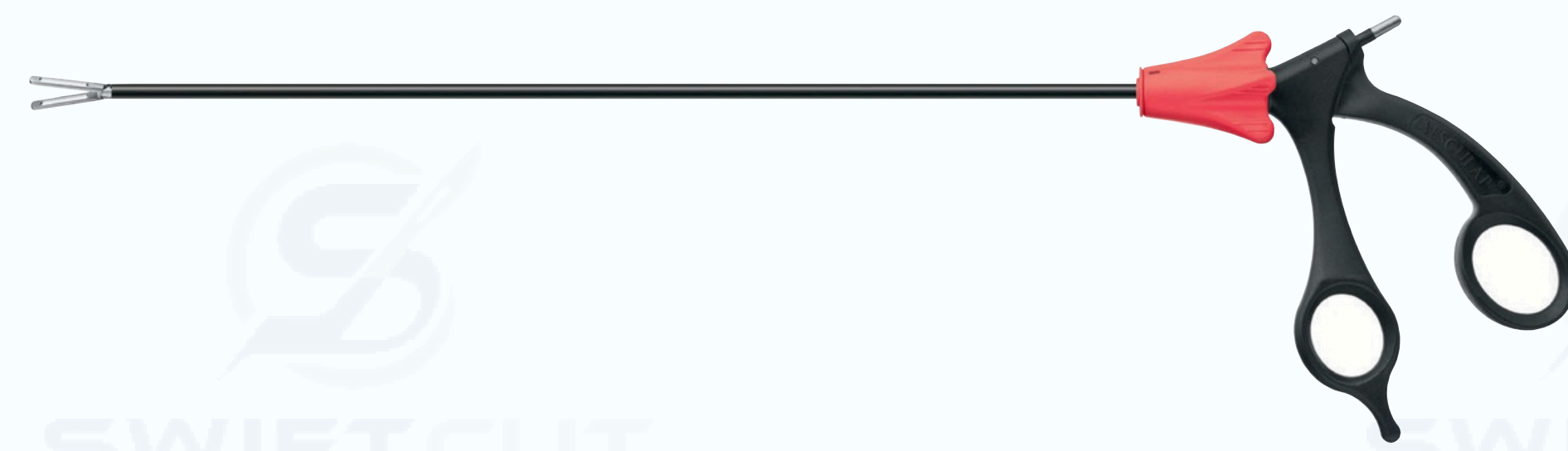

Reusable Monopolar Instruments

mini 3.5 mm

Individual Components			Optional Handles - Interchangeable for 3.5 mm Instruments
Jaw Insert	Insulated Outer Tube	Standard Handle	
SC340R 	SC986P 	SC380R 	SC380R (Quick-Snap™ Non-Ratchet)
SC360R 	SC987P 		
SC341R 	SC986P 	SC380R 	SC381R (Quick-Snap™ Ratchet)
SC361R 	SC987P 		
SC342R 	SC986P 	SC380R 	
SC362R 	SC987P 		
SC343R 	SC986P 	SC380R 	
SC363R 	SC987P 		
SC344R 	SC986P 	SC380R 	
SC364R 	SC987P 		

Complete Instrument				
Description	Item No.	Diam.	Length	
 DORSEY Intestinal forceps 1/1	SC305R	3.5 mm	29 cm	
	SC325R	3.5 mm	20 cm	
 Universal grasping forceps, fenestrated 1/1	SC306R	3.5 mm	29 cm	
	SC326R	3.5 mm	20 cm	
 BABCOCK Grasping forceps, double action 1/1	SC307R	3.5 mm	29 cm	
	SC327R	3.5 mm	20 cm	
 Biopsy forceps, fenestrated 1/1	SC308R	3.5 mm	29 cm	
	SC328R	3.5 mm	20 cm	
 Fundus grasper 1/1	SC309R	3.5 mm	29 cm	
	SC329R	3.5 mm	20 cm	



Reusable Monopolar Instruments

Scissors

Individual Components			Optional Handles - Interchangeable for 3.5 mm Instruments
Jaw Insert	Insulated Outer Tube	Standard Handle	
SC345R 	SC986P 	SC381R 	SC380R (Quick-Snap™ Non-Ratchet)
SC365R 	SC987P 		
SC346R 	SC986P 	SC381R 	SC381R (Quick-Snap™ Ratchet)
SC366R 	SC987P 		
SC347R 	SC986P 	SC381R 	
SC367R 	SC987P 		
SC348R 	SC986P 	SC381R 	
SC368R 	SC987P 		
SC349R 	SC986P 	SC381R 	
SC369R 	SC987P 		

Complete Instrument				
Description	Item No.	Diam.	Length	
 1/1	SC090R	5 mm	31 cm	
 1/1	SC091R	5 mm	31 cm	
 1/1	SC004R	5 mm	31 cm	
 1/1	SC027R	5 mm	42 cm	
 1/1	SC015R	5 mm	31 cm	
 1/1	Order by Component	10 mm	31 cm	



Reusable Monopolar Instruments

Scissors

Individual Components			Optional Handles - Interchangeable for 5 mm and 10 mm Instruments
Jaw Insert	Insulated Outer Tube	Standard Handle	
SC790R 	SC973R 	SC958R 	SC958R (Quick-Snap™ Non-Ratchet)
SC791R 	SC973R 	SC958R 	SC959R (Quick-Snap™ Ratchet)
SC603R 	SC973R 	SC958R 	SC950R (Insulated Metal Non-Ratchet)
SC746R 	SC981R 	SC958R 	SC951R (Insulated Metal Ratchet)
SC697R 	SC973R 	SC950R 	SC953R (Axial/In-Line)
SC604R 	SC974R 	SC958R 	SC954R (Ratchet)
			SC957R (Ratchet with lock)

Complete Instrument				
Description	Item No.	Diam.	Length	
 Medium METZENBAUM Scissors, serrated, tungsten carbide inserts 1/1	SC030R	5 mm	31 cm	
	SC031R	5 mm	42 cm	
	SC023R	5 mm	22 cm	
 Mini METZENBAUM Scissors, serrated, tungsten carbide inserts 1/1	SC011R	5 mm	31 cm	
	SC028R	5 mm	42 cm	
 Mini METZENBAUM Scissors, serrated, tungsten carbide inserts, insulated of the tip 1/1	SC016R	5 mm	31 cm	
 Mini METZENBAUM Scissors, serrated, tungsten carbide inserts, insulated of the tip 1/1	Order by Component	5 mm	31 cm	

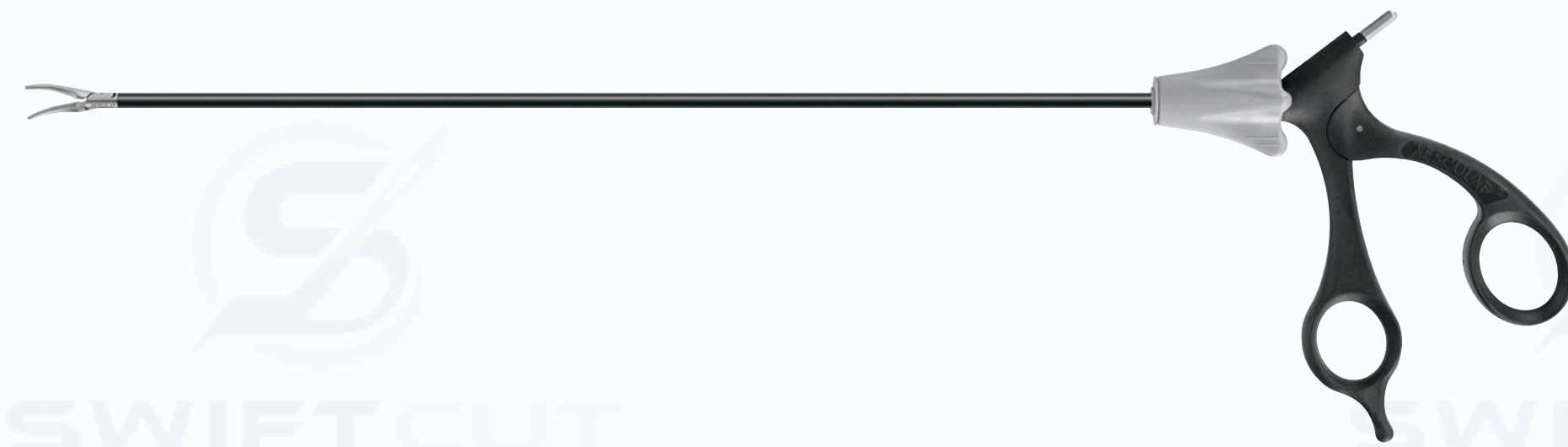

Reusable Monopolar Instruments

Dissecting Forceps

Individual Components			Optional Handles - Interchangeable for 5 mm and 10 mm Instruments
Jaw Insert	Insulated Outer Tube	Standard Handle	
SC600R 	SC973R 	SC958R 	SC958R (Quick-Snap™ Non-Ratchet)
SC744R 	SC981R 	SC958R 	SC959R (Quick-Snap™ Ratchet)
SC601R 	SC973R 	SC958R 	SC950R (Insulated Metal Non-Ratchet)
SC625R 	SC973R 	SC958R 	SC951R (Insulated Metal Ratchet)
SC602R 	SC973R 	SC958R 	SC953R (Axial/In-Line)
SC745R 	SC981R 	SC958R 	SC954R (Ratchet)
SC682R 	SC992R 	SC958R 	SC957R (Ratchet with lock)

Complete Instrument				
	Description	Item No.	Diam.	Length
	MARYLAND Dissecting forceps	SC102R	5 mm	31 cm
	MARYLAND Dissecting forceps	SC202R	5 mm	42 cm
	MARYLAND Dissecting forceps, insulated to tip	SC165R	5 mm	31 cm
	MARYLAND Dissecting forceps, diamond serration	SC237R	5 mm	31 cm
	MARYLAND Dissecting forceps, diamond serration	SC238R	5 mm	42 cm
	CROCE/OLMI Dissecting forceps, fenestrated	SC195R	5 mm	31 cm
	Dolphin nose dissecting forceps	SC147R	5 mm	31 cm



Reusable Monopolar Instruments

Dissecting Forceps

Individual Components			Optional Handles - Interchangeable for 5 mm and 10 mm Instruments
Jaw Insert	Insulated Outer Tube	Standard Handle	
SC608R 	SC973R 	SC958R 	SC958R (Quick-Snap™ Non-Ratchet)
SC752R 	SC981R 	SC958R 	SC959R (Quick-Snap™ Ratchet)
SC699R 	SC973R 	SC950R 	SC950R (Insulated Metal Non-Ratchet)
			SC951R (Insulated Metal Ratchet)
			SC953R (Axial/In-Line)
SC740R 	SC973R 	SC958R 	SC954R (Ratchet)
SC678R 	SC973R 	SC958R 	SC957R (Ratchet with lock)

Complete Instrument				
Description	Item No.	Diam.	Length	
 1/1	SC100R	5 mm	31 cm	
 1/1	Order by Component	5 mm	31 cm	
 1/1	SC187R	5 mm	31 cm	
 1/1	SC231R	5 mm	31 cm	
 1/1	SC214R	5 mm	37 cm	
 1/1	SC151R	5 mm	31 cm	
 1/1	SC103R	10 mm	31 cm	
 1/1	Order by Component	10 mm	37 cm	



Reusable Monopolar Instruments

Dissecting Forceps

Individual Components			Optional Handles - Interchangeable for 5 mm and 10 mm Instruments
Jaw Insert	Insulated Outer Tube	Standard Handle	
SC605R 	SC973R 	SC958R 	SC958R (Quick-Snap™ Non-Ratchet)
SC614R 	SC973R 	SC958R 	SC959R (Quick-Snap™ Ratchet)
SC730R 	SC973R 	SC958R 	SC950R (Insulated Metal Non-Ratchet)
SC784R 	SC973R 	SC958R 	SC951R (Insulated Metal Ratchet)
SC767R 	SC976R 	SC958R 	SC953R (Axial/In-Line)
SC667R 	SC973R 	SC958R 	SC954R (Ratchet)
SC606R 	SC975R 	SC958R 	SC957R (Ratchet with lock)
SC701R 	SC978R 	SC950R 	

Complete Instrument				
Description	Item No.	Diam.	Length	
OVERHOLT 90° dissecting forceps, fine tip 1/1	SC219R	10 mm	37 cm	
OVERHOLT 60° dissecting forceps 1/1	SC141R	10 mm	31 cm	
OVERHOLT 60° dissecting forceps, insulated to tip 1/1	Order by Component	10 mm	31 cm	
OVERHOLT 60° dissecting forceps, fine tip 1/1	SC220R	10 mm	37 cm	
CRILE Dissecting forceps, curved 1/1	SC218R	5 mm	31 cm	
	SC213R	5 mm	37 cm	

Reusable Monopolar Instruments

Grasping Forceps

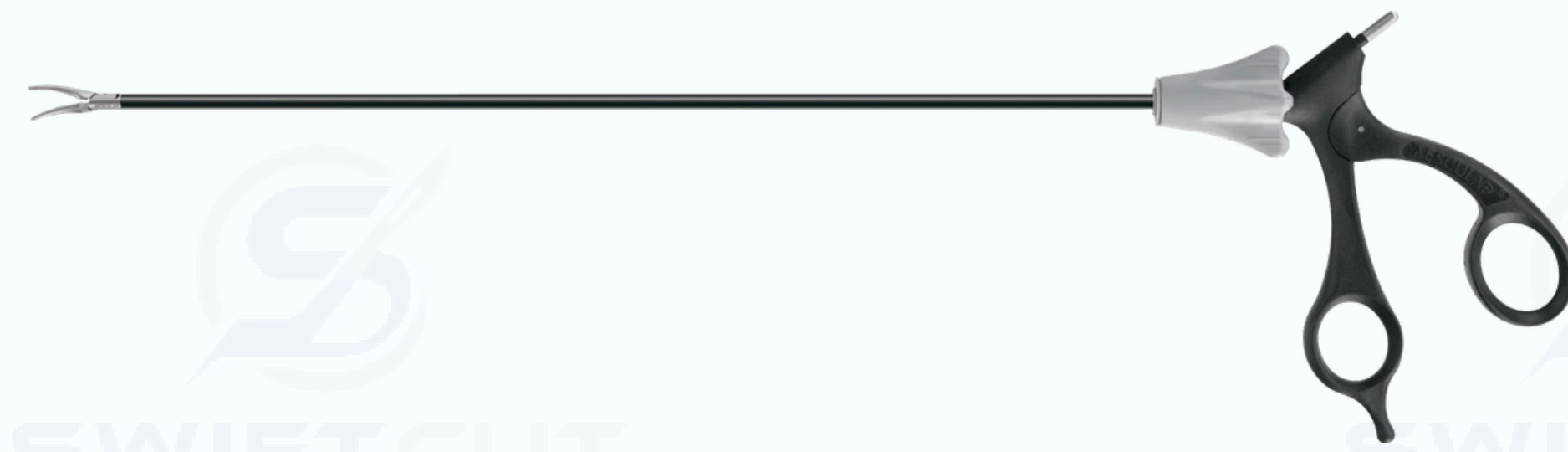

Individual Components			Optional Handles - Interchangeable for 5 mm and 10 mm Instruments
Jaw Insert	Insulated Outer Tube	Standard Handle	
SC772R 	SC978R 	SC958R 	SC958R (Quick-Snap™ Non-Ratchet)
SC661R 	SC975R 	SC958R 	SC959R (Quick-Snap™ Ratchet)
SC700R 	SC975R 	SC950R 	SC950R (Insulated Metal Non-Ratchet)
SC773R 	SC978R 	SC958R 	SC951R (Insulated Metal Ratchet)
SC771R 	SC973R 	SC958R 	SC953R (Axial/In-Line)
SC766R 	SC976R 	SC958R 	SC954R (Ratchet)
			SC957R (Ratchet with lock)

Complete Instrument				
Description	Item No.	Diam.	Length	
 Alligator grasping forceps 1/1	SC109R	5 mm	31 cm	
 Fixation forceps 1/1	SC127R	5 mm	31 cm	
 Atraumatic wave grasper, single action 1/1	SC233R	5 mm	31 cm	
 Atraumatic wave grasper, double action 1/1	SC234R	5 mm	42 cm	
 Atraumatic wave grasper, double action 1/1	SC235R	5 mm	31 cm	
 Atraumatic wave grasper, double action 1/1	SC236R	5 mm	42 cm	
 Fundus grasper 1/1	SC221R	5 mm	31 cm	
 Fundus grasper 1/1	SC230R	5 mm	42 cm	



Reusable Monopolar Instruments

Grasping Forceps

Individual Components			Optional Handles - Interchangeable for 5 mm and 10 mm Instruments
Jaw Insert	Insulated Outer Tube	Standard Handle	
SC615R 	SC973R 	SC959R 	SC958R (Quick-Snap™ Non-Ratchet)
SC644R 	SC973R 	SC959R 	SC959R (Quick-Snap™ Ratchet)
SC786R 	SC973R 	SC959R 	SC950R (Insulated Metal Non-Ratchet)
SC787R 	SC981R 	SC959R 	SC951R (Insulated Metal Ratchet)
SC788R 	SC973R 	SC959R 	SC953R (Axial/In-Line)
SC789R 	SC981R 	SC959R 	SC954R (Ratchet)
SC774R 	SC973R 	SC959R 	SC957R (Ratchet with lock)
SC783R 	SC981R 	SC959R 	

Description	Complete Instrument		
	Item No.	Diam.	Length
 1/1	SC216R	5 mm	31 cm
 1/1	SC217R	5 mm	42 cm
 1/1	SC128R	5 mm	31 cm
 1/1	SC229R	5 mm	42 cm
 1/1	SC191R	5 mm	31 cm
 1/1	SC185R	5 mm	31 cm
 1/1	SC232R	5 mm	31 cm

Reusable Monopolar Instruments

Grasping Forceps

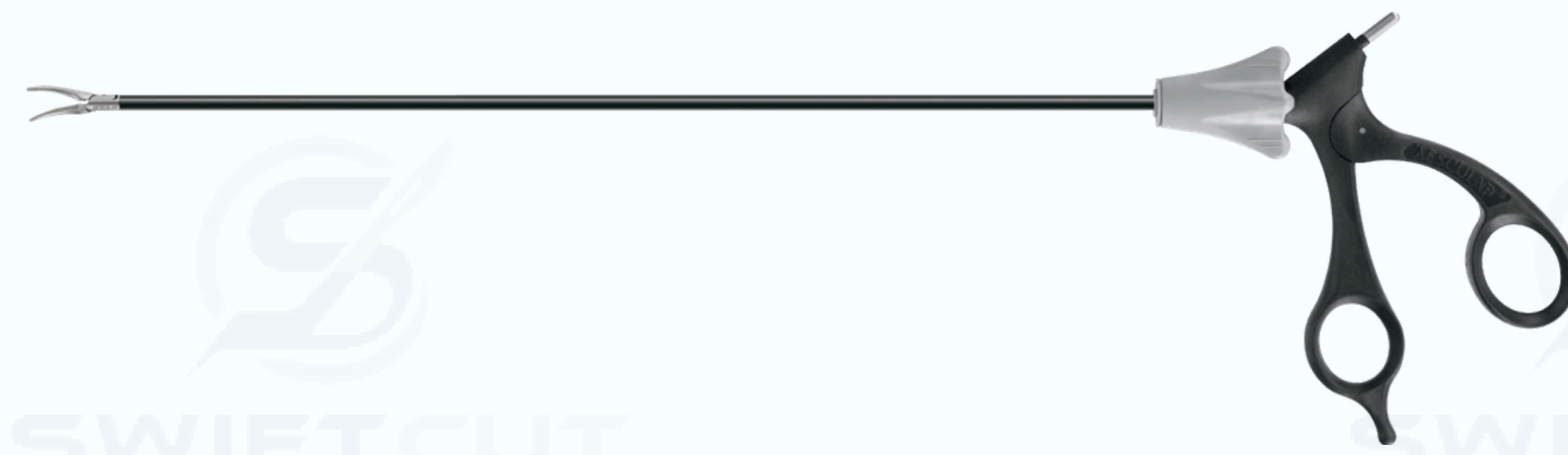

Individual Components			Optional Handles - Interchangeable for 5 mm and 10 mm Instruments
Jaw Insert	Insulated Outer Tube	Standard Handle	
SC769R 	SC973R 	SC958R 	SC958R (Quick-Snap™ Non-Ratchet)
SC770R 	SC981R 	SC958R 	SC959R (Quick-Snap™ Ratchet)
SC647R 	SC973R 	SC959R 	SC950R (Insulated Metal Non-Ratchet)
SC782R 	SC981R 	SC959R 	SC951R (Insulated Metal Ratchet)
SC736R 	SC973R 	SC959R 	SC953R (Axial/In-Line)
SC728R 	SC973R 	SC959R 	SC954R (Ratchet)
SC785R 	SC973R 	SC959R 	SC957R (Ratchet with lock)

Complete Instrument				
Description	Item No.	Diam.	Length	
 Short grasper, fenestrated 1/1	SC222R	5 mm	31 cm	
 Short grasper, fenestrated 1/1	SC223R	5 mm	42 cm	
 DORSEY Intestinal forceps 1/1	SC112R	5 mm	31 cm	
 DORSEY Intestinal forceps 1/1	SC204R	5 mm	42 cm	
 Pike mouth grasper 1/1	Order by Component	5 mm	22 cm	
 Pike mouth grasper 1/1	SC107R	5 mm	31 cm	
 Pike mouth grasper 1/1	Order by Component	10 mm	31 cm	



Reusable Monopolar Instruments

Grasping Forceps

Individual Components			Optional Handles - Interchangeable for 5 mm and 10 mm Instruments
Jaw Insert	Insulated Outer Tube	Standard Handle	
SC775R 	SC973R 	SC959R 	SC958R (Quick-Snap™ Non-Ratchet)
SC776R 	SC981R 	SC959R 	SC959R (Quick-Snap™ Ratchet)
SC618R 	SC973R 	SC959R 	SC950R (Insulated Metal Non-Ratchet)
SC755R 	SC981R 	SC959R 	SC951R (Insulated Metal Ratchet)
SC634R 	SC970R 	SC959R 	SC953R (Axial/In-Line)
SC613R 	SC973R 	SC959R 	SC954R (Ratchet)
SC621R 	SC974R 	SC959R 	SC957R (Ratchet with lock)

		Complete Instrument		
	Description	Item No.	Diam.	Length
 1/1	Claw grasper, 2 x 3 teeth	SC117R	10 mm	31 cm
 1/1	Grasping forceps, 2 x 4 teeth	SC132R	5 mm	31 cm
 1/1	Grasping forceps, 1 x 2 teeth	SC201R	5 mm	42 cm
 1/1	Grasping forceps, fine teeth	Order by Component	5 mm	31 cm
 1/1	BABCOCK Grasping forceps, single action	SC134R	5 mm	31 cm
 1/1	BABCOCK Grasping forceps, single action For use with flexible 13 mm trocars	Order by Component	5 mm	31 cm



Reusable Monopolar Instruments

Grasping Forceps

Individual Components			Optional Handles - Interchangeable for 5 mm and 10 mm Instruments
Jaw Insert	Insulated Outer Tube	Standard Handle	
SC623R 	SC974R 	SC959R 	SC958R (Quick-Snap™ Non-Ratchet)
SC648R 	SC973R 	SC959R 	SC959R (Quick-Snap™ Ratchet)
SC749R 	SC981R 	SC959R 	SC950R (Insulated Metal Non-Ratchet)
SC649R 	SC973R 	SC959R 	SC951R (Insulated Metal Ratchet)
SC650R 	SC973R 	SC959R 	SC953R (Axial/In-Line)
SC619R 	SC973R 	SC959R 	SC954R (Ratchet)
SC640R 	SC973R 	SC959R 	SC957R (Ratchet with lock)

Complete Instrument				
Description	Item No.	Diam.	Length	
 BABCOCK Grasping forceps, single action 1/1	SC114R	10 mm	31 cm	
	SC205R	10 mm	42 cm	
 BABCOCK Grasping forceps, double action 1/1	SC212R	5 mm	31 cm	
	SC209R	5 mm	42 cm	
 BABCOCK Grasping forceps, double action 1/1	SC196R	10 mm	37 cm	
 MEYER Grasping forceps, jaw length 90 mm 1/1	SC197R	10 mm	37 cm	
 ALLIS Atraumatic grasping forceps 1/1	SC104R	5 mm	31 cm	
 ALLIS Atraumatic grasping forceps For use with flexible 13 mm trocars 1/1	Order by Component	5 mm	31 cm	

Reusable Monopolar Instruments

Grasping Forceps



Individual Components			Optional Handles - Interchangeable for 5 mm and 10 mm Instruments
Jaw Insert	Insulated Outer Tube	Standard Handle	
SC620R 	SC974R 	SC959R 	SC958R (Quick-Snap™ Non-Ratchet)
SC757R 	SC982R 	SC959R 	SC959R (Quick-Snap™ Ratchet)
SC765R 	SC973R 	SC959R 	SC950R (Insulated Metal Non-Ratchet)
SC762R 	SC981R 	SC959R 	SC951R (Insulated Metal Ratchet)
SC741R 	SC977R 	SC959R 	SC953R (Axial/In-Line)
SC742R 	SC977R 	SC959R 	SC954R (Ratchet)
SC610R 	SC973R 	SC958R 	SC957R (Ratchet with lock)
SC670R 	SC973R 	SC959R 	

Complete Instrument				
Description	Item No.	Diam.	Length	
LINDER Lunggraspingforceps For use with flexible 13 mm trocars	Order by Component	5 mm	22 cm	
	Order by Component	5 mm	31 cm	
DUVAL Atraumatic parenchyma fixation forceps	Order by Component	5 mm	31 cm	
DUVAL Atraumatic parenchyma fixation forceps	Order by Component	10 mm	37 cm	
KIEFER Atraumatic universal forceps, fenestrated	SC188R	10 mm	31 cm	
GLASSMAN Clamping forceps, jaw length 60 mm	SC215R	10 mm	31 cm	
CROCE/OLMI Fixation forceps	SC186R	5 mm	31 cm	
HEYWOOD-SMITH Tissue grasping forceps	SC105R	10 mm	31 cm	



Reusable Monopolar Instruments

Grasping Forceps

Jaw Insert	Individual Components Insulated Outer Tube	Standard Handle	Optional Handles - Interchangeable for 5 mm and 10 mm Instruments
SC696R 	SC970R 	SC958R 	SC958R (Quick-Snap™ Non-Ratchet)
SC687R 	SC973R 	SC958R 	SC959R (Quick-Snap™ Ratchet)
SC609R 	SC973R 	SC959R 	SC950R (Insulated Metal Non-Ratchet)
SC612R 	SC977R 	SC959R 	SC951R (Insulated Metal Ratchet)
SC731R 	SC975R 	SC959R 	SC953R (Axial/In-Line)
SC768R 	SC974R 	SC959R 	SC954R (Ratchet)
SC729R 	SC973R 	SC959R 	SC957R (Ratchet with lock)
SC611R 	SC975R 	SC959R 	

Description	Complete Instrument		
	Item No.	Diam.	Length
 PENNINGTON Tissue grasping forceps 1/1	Order by Component	10 mm	37 cm
 Curved grasper 1/1	SC211R	5 mm	31 cm
 Fixation forceps, fenestrated, fine serration 1/1	SC208R	5 mm	42 cm
 Fixation forceps, fenestrated, medium size serration 1/1	SC149R	5 mm	31 cm
 Fixation forceps, fenestrated, medium size serration 1/1	SC206R	5 mm	31 cm
 Atraumatic grasping forceps, fenestrated 1/1	SC130R	5 mm	31 cm

Reusable Monopolar Instruments

Grasping Forceps

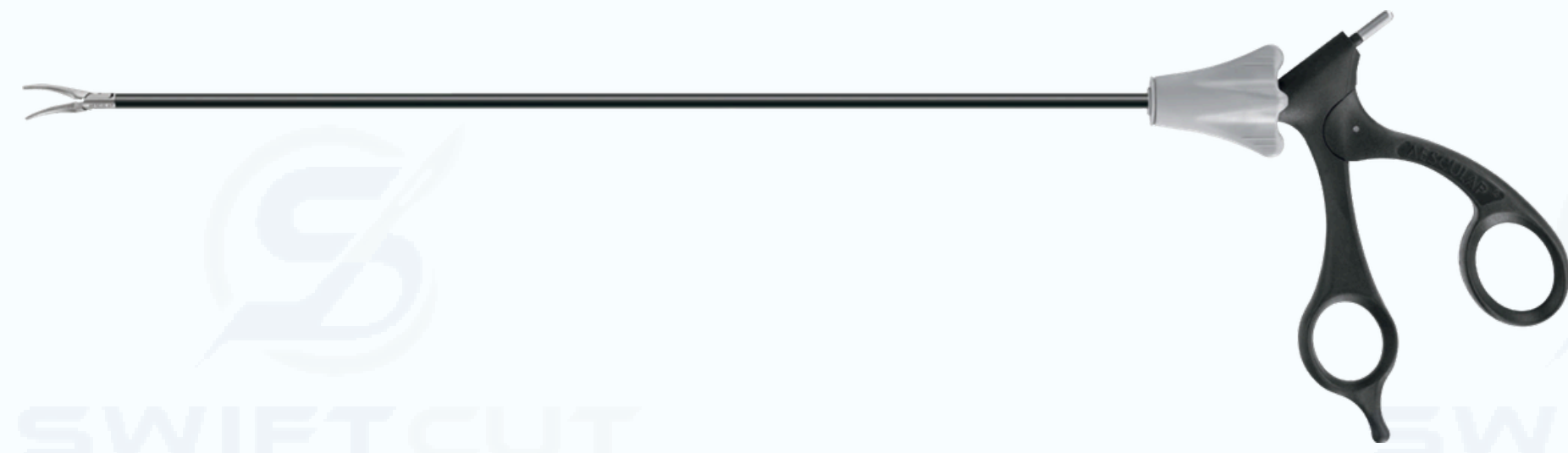

Individual Components			Optional Handles - Interchangeable for 5 mm and 10 mm Instruments
Jaw Insert	Insulated Outer Tube	Standard Handle	
SC679R 	SC977R 	SC959R 	SC958R (Quick-Snap™ Non-Ratchet)
SC764R 	SC973R 	SC958R 	SC959R (Quick-Snap™ Ratchet)
SC761R 	SC981R 	SC958R 	SC950R (Insulated Metal Non-Ratchet)
SC680R 	SC973R 	SC958R 	SC951R (Insulated Metal Ratchet)
SC758R 	SC973R 	SC958R 	SC953R (Axial/In-Line)
SC646R 	SC973R 	SC958R 	SC954R (Ratchet)
			SC957R (Ratchet with lock)

Description	Complete Instrument		
	Item No.	Diam.	Length
 Atraumatic fixation forceps 1/1	Order by Component	5 mm	22 cm
 Atraumatic fixation forceps 1/1	SC101R	5 mm	31 cm
 Atraumatic fixation forceps 1/1	SC199R	5 mm	42 cm
 Bullet nose grasper 1/1	SC190R	5 mm	31 cm
 Bullet nose grasper 1/1	SC203R	5 mm	42 cm
 Tube fixation forceps 1/1	SC129R	5 mm	31 cm
 Tube fixation forceps 1/1	SC200R	5 mm	42 cm

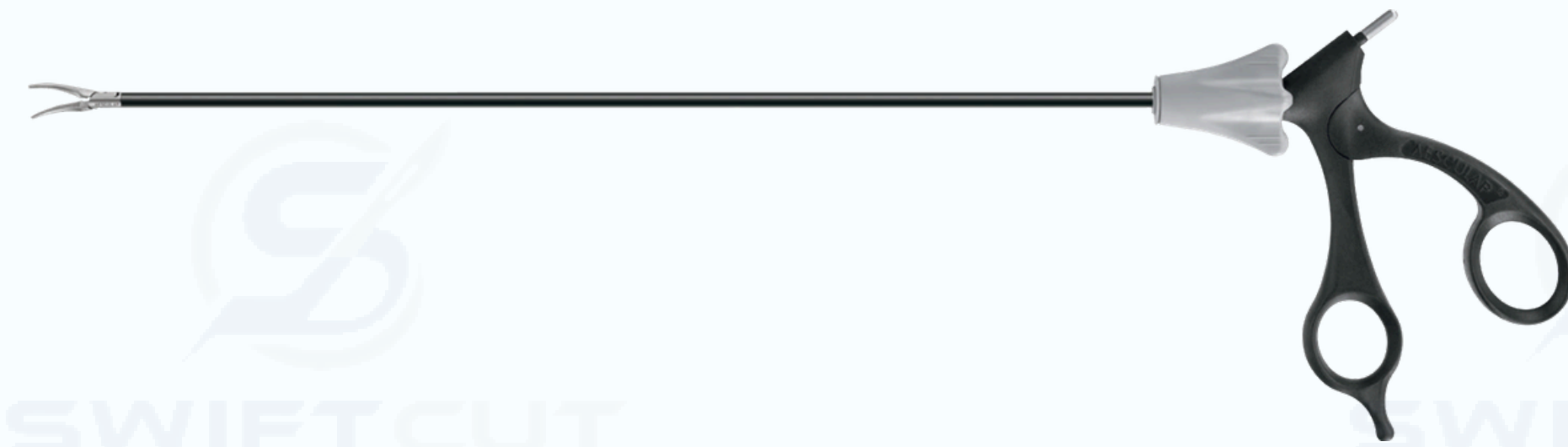

Reusable Monopolar Instruments

Grasping Forceps

Individual Components			Optional Handles - Interchangeable for 5 mm and 10 mm Instruments
Jaw Insert	Insulated Outer Tube	Standard Handle	
SC633R 	SC970R 	SC958R 	SC958R (Quick-Snap™ Non-Ratchet)
SC607R 	SC973R 	SC958R 	SC959R (Quick-Snap™ Ratchet)
SC747R 	SC981R 	SC958R 	SC950R (Insulated Metal Non-Ratchet)
SC735R 	SC973R 	SC958R 	SC951R (Insulated Metal Ratchet)
SC753R 	SC981R 	SC958R 	SC953R (Axial/In-Line)
SC645R 	SC973R 	SC958R 	SC954R (Ratchet)
SC748R 	SC981R 	SC958R 	SC957R (Ratchet with lock)

Description	Complete Instrument		
	Item No.	Diam.	Length
 1/1	SC210R	5 mm	31 cm
 1/1	SC207R	5 mm	42 cm
 1/1	Order by Component	10 mm	31 cm
 1/1	Order by Component	10 mm	31 cm
 1/1	SC189R	5 mm	31 cm
 1/1	SC111R	5 mm	31 cm
 1/1	SC224R	5 mm	31 cm



Reusable Monopolar Instruments

Grasping Forceps

Individual Components			Optional Handles - Interchangeable for 5 mm and 10 mm Instruments
Jaw Insert	Insulated Outer Tube	Standard Handle	
SC763R 	SC973R 	SC958R 	SC958R (Quick-Snap™ Non-Ratchet)
SC760R 	SC981R 	SC958R 	SC959R (Quick-Snap™ Ratchet)
SC743R 	SC974R 	SC959R 	SC950R (Insulated Metal Non-Ratchet)
SC681R 	SC974R 	SC959R 	SC951R (Insulated Metal Ratchet)
SC734R 	SC973R 	SC958R 	SC953R (Axial/In-Line)
SC617R 	SC973R 	SC959R 	SC954R (Ratchet)
SC777R 	SC973R 	SC959R 	SC957R (Ratchet with lock)

Description	Complete Instrument		
	Item No.	Diam.	Length
 1/1	SC225R	10 mm	31 cm
 1/1	SC194R	5 mm	22 cm
 1/1	Order by Component	10 mm	31 cm
 1/1	Order by Component	5 mm	31 cm
 1/1	SC137R	5 mm	42 cm
 1/1	Order by Component	5 mm	31 cm
 1/1	Order by Component	10 mm	37 cm
 1/1	Order by Component	10 mm	22 cm
	SC118R	10 mm	37 cm

Reusable Monopolar Instruments

Biopsy Forceps

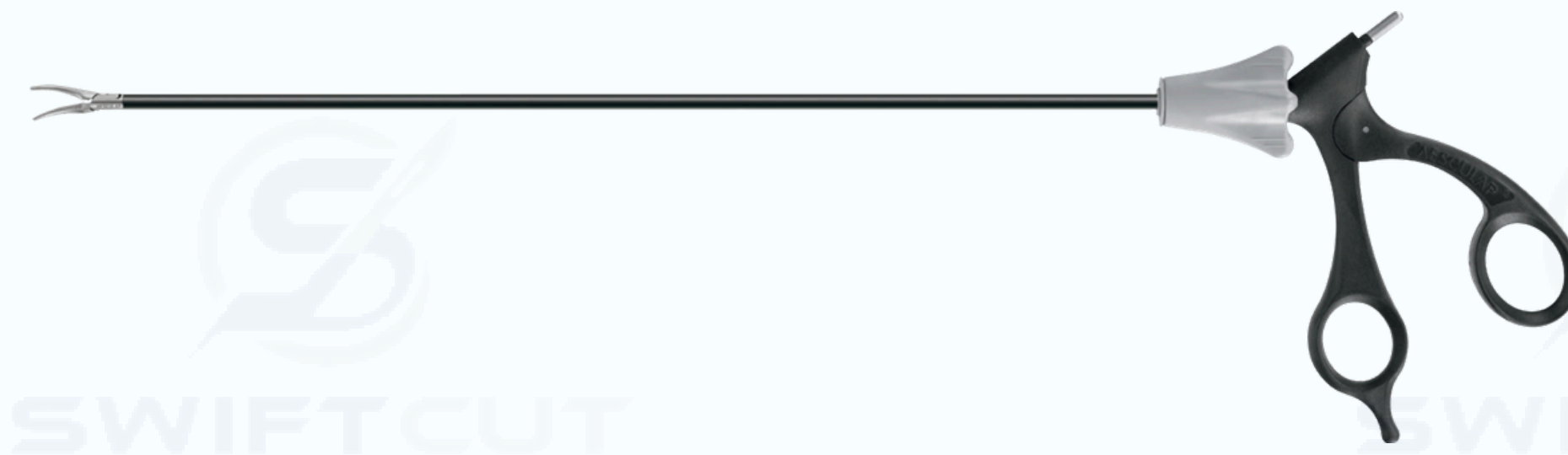

Individual Components			Optional Handles - Interchangeable for 5 mm and 10 mm Instruments
Jaw Insert	Insulated Outer Tube	Standard Handle	
SC778R 	SC974R 	SC959R 	<p>SC958R (Quick-Snap™ Non-Ratchet) </p> <p>SC959R (Quick-Snap™ Ratchet) </p> <p>SC950R (Insulated Metal Non-Ratchet) </p> <p>SC951R (Insulated Metal Ratchet) </p> <p>SC953R (Axial/In-Line) </p> <p>SC954R (Ratchet) </p> <p>SC957R (Ratchet with lock) </p>
SC739R 	SC970R 	SC959R 	
SC688R 	SC974R 	SC959R 	
SC657R 	SC973R 	SC959R 	
SC657R 	SC981R 	SC959R 	
SC658R 	SC973R 	SC959R 	
SC651R 	SC977R 	SC959R 	
SC712R 	SC992R 	SC959R 	
SC624R 	SC977R 	SC959R 	

Complete Instrument				
Description	Item No.	Diam.	Length	
 Large biopsy forceps 1/1	SC500R	10 mm	31 cm	
 Biopsy forceps, fenestrated 1/1	P0501R	5 mm	31 cm	
 Biopsy forceps with teeth 1/1	SC509R	5 mm	42 cm	
 Biopsy punch forceps 1/1	SC505R	5 mm	31 cm	
 Biopsy punch forceps 1/1	SC511R	5 mm	42 cm	
 Biopsy punch forceps 1/1	SC502R	5 mm	31 cm	
 Biopsy punch forceps 1/1	SC512R	5 mm	42 cm	
 Biopsy punch forceps 1/1	SC510R	5 mm	42 cm	



Reusable Monopolar Instruments

Spare Parts

Individual Components			Optional Handles - Interchangeable for 5 mm and 10 mm Instruments
Jaw Insert	Insulated Outer Tube	Standard Handle	
SC705R 	SC974R 	SC958R 	SC958R (Quick-Snap™ Non-Ratchet)
SC626R 	SC973R 	SC958R 	SC959R (Quick-Snap™ Ratchet)
SC750R 	SC981R 	SC958R 	SC950R (Insulated Metal Non-Ratchet)
SC652R 	SC973R 	SC958R 	SC951R (Insulated Metal Ratchet)
SC756R 	SC981R 	SC958R 	SC953R (Axial/In-Line)
SC627R 	SC973R 	SC958R 	SC954R (Ratchet)
SC759R 	SC981R 	SC958R 	SC957R (Ratchet with lock)
SC751R 	SC981R 	SC958R 	

3.5 mm Instruments	Item No.	Diam.	Length
	SC362810	3.5 mm	20 cm
	SC342810	3.5 mm	29 cm
	SC987P	3.5/3.5 mm	20 cm
	SC986P	3.5/3.5 mm	29 cm
5 mm and 10 mm Instruments	Item No.	Diam.	Length
	SC630201	-	22 cm
	SC600201	-	31 cm
	SC618201	-	37 cm
	SC434201	-	42 cm
	SC970R	5/5 mm	22 cm
	SC971R	5/10 mm	22 cm
	SC992R	10/10 mm	22 cm
	SC973R	5/5 mm	31 cm
	SC975R	5/10 mm	31 cm
	SC974R	10/10 mm	31 cm
	SC976R	5/5 mm	37 cm
	SC978R	5/10 mm	37 cm
	SC977R	10/10 mm	37 cm
	SC981R	5/5 mm	42 cm
	SC982R	10/10 mm	42 cm

Monopolar Electrodes

Monopolar Electrodes	Description	Item No.	Diam.	Length
Handle for monopolar laparoscopy electrodes		GK372R	5 mm	33 cm
		GK374R	5 mm	42 cm



	J Hook electrode tip	GK383R		
	L Hook electrode tip	GK384R		
	Ball electrode tip	GK385R		
	Spatula electrode tip	GK386R		

Spare Parts (Components of GK372R / GK374R)	Description	Item No.	Diam.	Length
Handle with inner tube		GK373R	5 mm	33 cm
		GK375R	5 mm	42 cm



Separate outer tube		GK370P	5 mm	33 cm
		GK376P	5 mm	42 cm

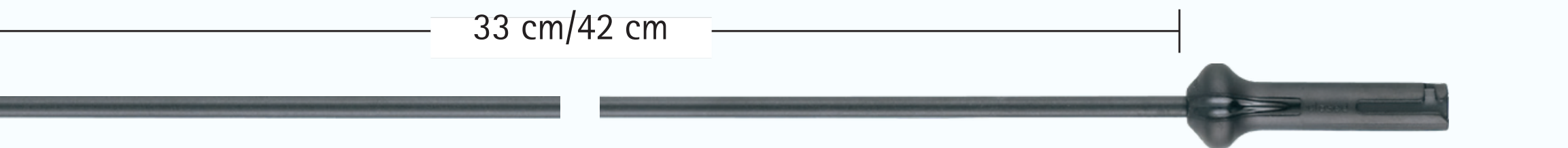

Micropin Electrode	Description	Item No.	Diam.	Length
	Low-energy micropin	GK390R	5 mm	33 cm



Spare Parts (Components of GK390R)	Description	Item No.	Diam.	Length
	Pin electrode only (pack of 5 pcs.)	GK389R		
	Handle with inner tube	GK373R	5 mm	33 cm
	Separate outer tube	GK371P	5 mm	33 cm

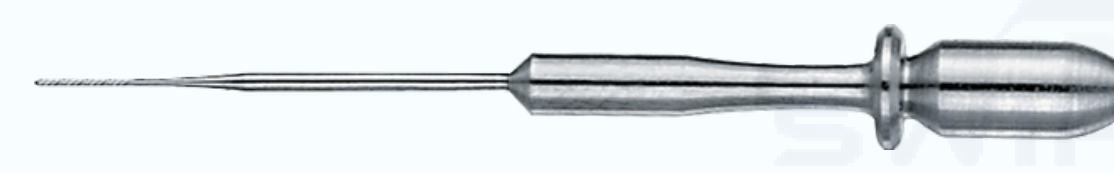

Monopolar Electrode	Description	Item No.	Diam.	Length
L-Hook electrode for use with electrode handle GN230		GK397R	3.5 mm	20 cm
		GK398R	3.5 mm	29 cm



HF Contact Pin	Description	Item No.
	SC handles package of 5 pieces	SC950400
	SC handles and monopolar electrode package of 5 pieces	PL170251

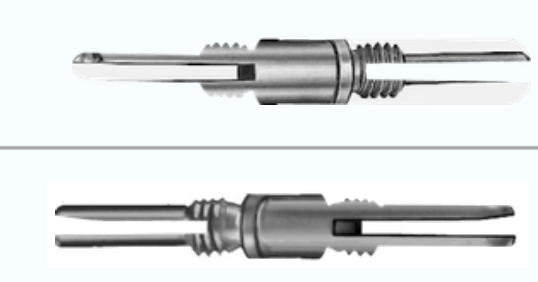

Rotation Knobs	Description	Item No.
	Rotation knob for SC950R and SC951R only. Package of 5 pieces	SC950250

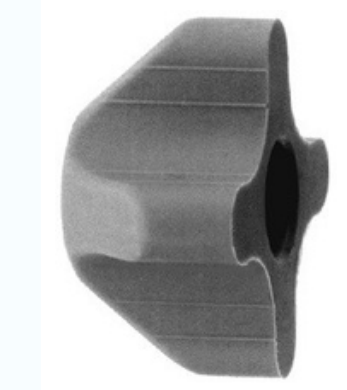

BIPOLAR INSTRUMENTS

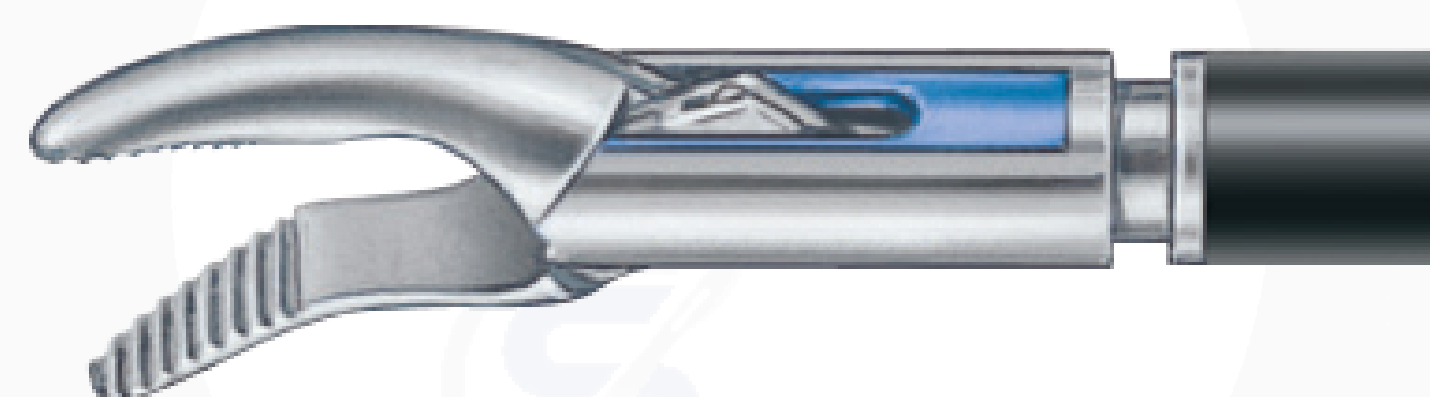

A precision range of bipolar forceps, cords, and accessories for localized electrosurgical coagulation. Current flows only between the two tips, delivering focused hemostasis with minimal lateral thermal spread – ideal for delicate tissue and confined spaces. Includes reusable and disposable options in multiple tip sizes and configurations. Ergonomic designs, secure connections, and high-grade insulation ensure safe, controlled, and consistent performance across neurosurgery, ophthalmic, ENT, and general surgical applications.



Single Use Bipolar Instruments

Scissors (box of 6)	Description	Item No.	Diam.	Length
 1/1	METZENBAUM Scissors	PL700	5 mm	31 cm











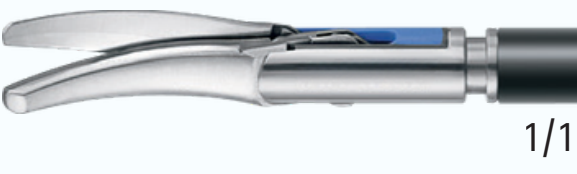
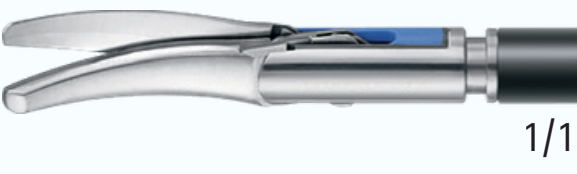
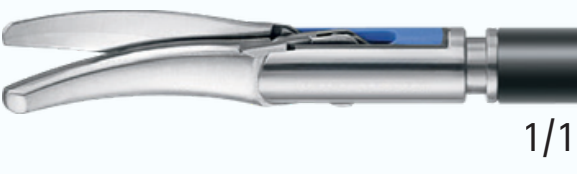

Forceps (box of 6)	Description	Item No.	Diam.	Length
 1/1	MARYLAND Dissection forceps, fenestrated	PL701	5 mm	31 cm
 1/1	MARYLAND Dissection forceps	PL702SU	5 mm	31 cm
 1/1	Macro grasping forceps	PL703SU	5 mm	31 cm

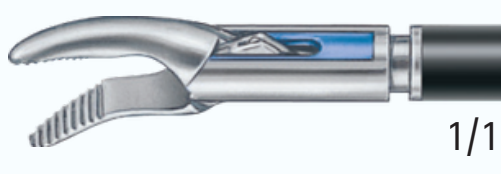
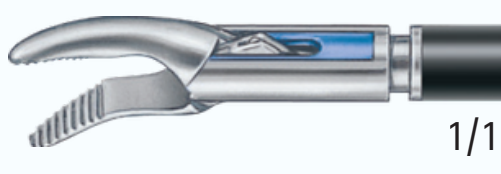
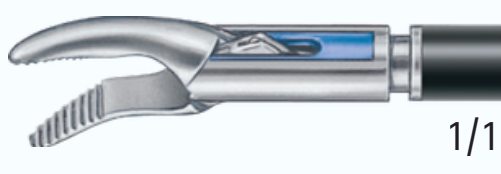

Reusable Bipolar Instruments

The enhanced safety of Ceramic Insulation in Reusable Bipolar Laparoscopic Modular Instruments



	Complete Instrument	Individual Components		
		Jaw Insert	Insulated Outer Tube	Standard Handle
 1/1	SC409R - METZENBAUM Scissors, 5 mm, 22 cm	SC439R	SC970R	SC450R
 1/1	SC400R - METZENBAUM Scissors, 5 mm, 31 cm	SC430R	SC973R	SC450R
 1/1	SC404R - METZENBAUM Scissors, 5 mm, 42 cm	SC434R	SC981R	SC450R
 1/1	SC414R - Mini METZENBAUM Scissors, 5 mm, 22 cm	SC444R	SC970R	SC450R
 1/1	SC407R - Mini METZENBAUM Scissors, 5 mm, 31 cm	SC437R	SC973R	SC450R
 1/1	SC410R - MARYLAND dissecting forceps, 5 mm, 22 cm	SC440R	SC970R	SC450R
 1/1	SC401R - MARYLAND dissecting forceps, 5 mm, 31 cm	SC431R	SC973R	SC450R
 1/1	SC405R - MARYLAND dissecting forceps, 5 mm, 42 cm	SC435R	SC981R	SC450R
 1/1	SC413R - MARYLAND dissecting forceps, fenestrated, 5 mm, 22 cm	SC443R	SC970R	SC450R
 1/1	SC408R - MARYLAND dissecting forceps, fenestrated, 5 mm, 31 cm	SC438R	SC973R	SC450R
 1/1	SC415R - MARYLAND dissecting forceps, fenestrated, 5 mm, 42 cm	SC445R	SC981R	SC450R
 1/1	SC402R - Micro forceps, 5 mm, 31 cm	SC432R	SC973R	SC450R
 1/1	SC412R - Macro forceps, 5 mm, 22 cm	SC442R	SC970R	SC450R
 1/1	SC403R - Macro forceps, 5 mm, 31 cm	SC433R	SC973R	SC450R
 1/1	SC406R - Macro forceps, 5 mm, 42 cm	SC436R	SC981R	SC450R
 1/1	SC433220 - Jaw protection cap			

SPECIALITY INSTRUMENTS

A comprehensive range of instruments for minimally invasive surgery, designed for precision through small access ports. Includes trocars, graspers, dissectors, scissors, needle holders, clip appliers, and suction/irrigation systems. Features 360° rotatable shafts, insulated monopolar/bipolar connectors, and ergonomic ring or ratchet handles for controlled, atraumatic tissue manipulation. High-grade stainless steel construction ensures durability, reliable insulation, and excellent performance across general, gynaecological, urological, and thoracic laparoscopic procedures.



Slide Lock Graspers

- Proven durability and holding power
- Excellent tissue and grip control
- Single and dual action models
- Fingertip rotation knob for optimal one-handed control
- Single piece instrument, flush port cleanable

Description	Sovereign®	
	36 cm	42 cm
 1/1 Atraumatic grasper, single action, non-rotatable, 5 mm	PL230R	PL231R
 1/1 Atraumatic grasper, double action, rotatable, 5 mm	PL232R	PL233R
 1/1 Retraction grasper, single action, non-rotatable, 5 mm	PL234R	—
 1/1 Retraction grasper, double action, rotatable, 5 mm	PL235R	—





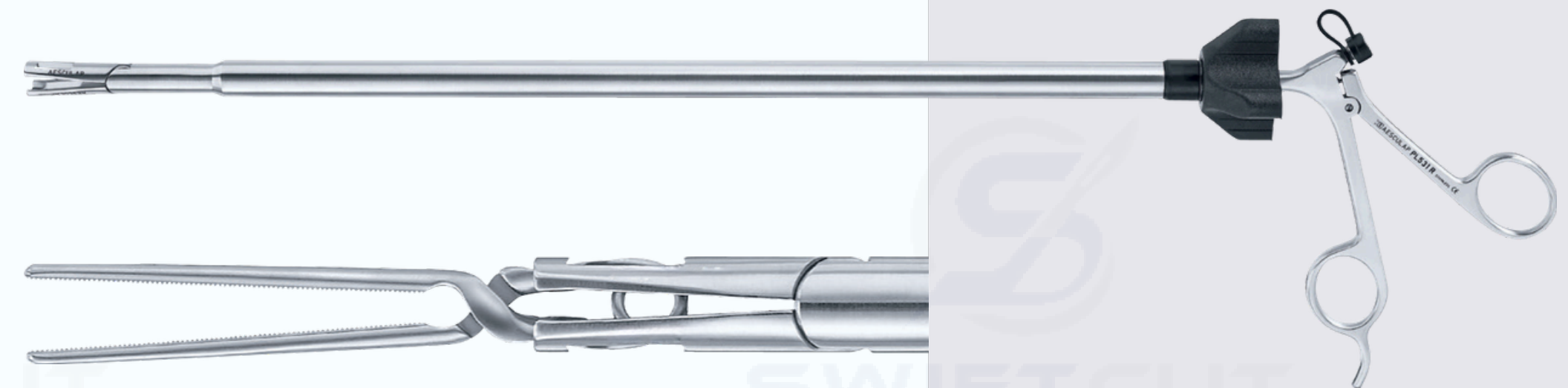





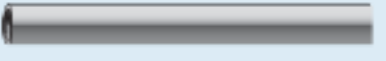
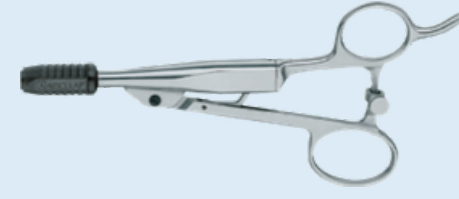

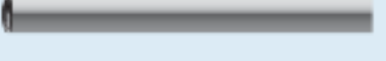



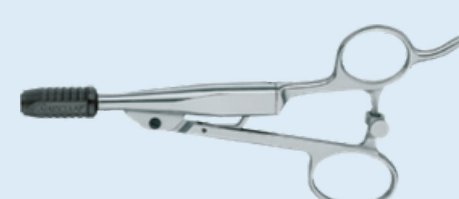



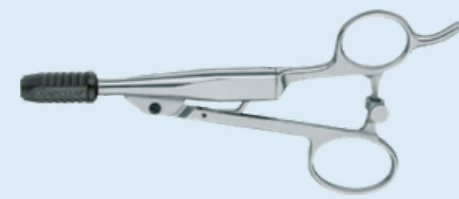

Bulldog Clips

Description	Item No.	Closing Force	Jaw Length	Jaw Shape
 Intestinal bulldog clip for temporary atraumatic occlusion	PL541S	400 g	70 mm	Straight
 Vessel bulldog clips with DEBAKEY jaws for temporary atraumatic occlusion	PL544S	350 g	25 mm	Straight
	PL545S	450 g	45 mm	Straight
	PL548S	350 g	25 mm	Curved
	PL549S	450 g	45 mm	Curved

Description	Item No.	Diameter	Length
 Articulating bulldog clip applicator/remover	PL530R	12.5 mm	35 cm
 Fixed bulldog clip applicator/remover	PL531R	12.5 mm	35 cm
Replacement rotation knob	PL664P		

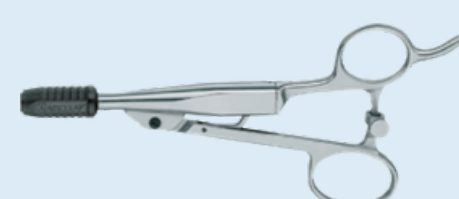
Specialty Instruments: Advanced Urology

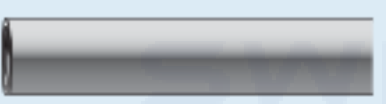
Complete Instrument				
	Description	Item No.	Diam.	Length
1/1	 CRAFOORD Endovascular Clamp, Short Jaw, <i>For use with 10 mm trocars</i>	SC173R	5 mm	31 cm
1/1	 CRAFOORD Endovascular Clamp, Long Jaw, <i>For use with 10 mm trocars</i>	SC178R	5 mm	31 cm
1/1	 SATINSKY Atraumatic Clamp, 38 mm Jaw, <i>For use with 13 mm flexible trocars</i>	SC171R	5 mm	31 cm
1/1	 SATINSKY Atraumatic Clamp, 51 mm Jaw, <i>For use with 13 mm flexible trocars</i>	SC177R	5 mm	31 cm
1/1	 DEBAKEY Atraumatic Clamp, S-shaped, <i>For use with 13 mm flexible trocars</i>	SC176R	5 mm	31 cm
1/1	 DEBAKEY Atraumatic Clamp, Curved, <i>For use with 13 mm flexible trocars</i>	SC175R	5 mm	31 cm
1/1	 SIMON Renal Pole Clamp, 100 mm Jaw	SC228R	10 mm	37 cm

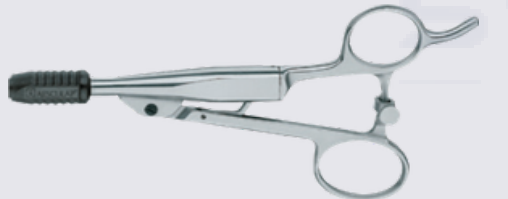
Individual Components				Optional Handles – Interchangeable for 5 mm and 10 mm Instruments
	Jaw Insert	Insulated Outer Tube	Standard Handle	
	SC713R 	SC973R 	SC957R 	SC958R (Quick-Snap™ Non-Ratchet) 
	SC719R 	SC973R 	SC957R 	SC959R (Quick-Snap™ Ratchet) 
	SC711R 	SC973R 	SC957R 	SC950R (Insulated Metal Non-Ratchet) 
	SC616R 	SC973R 	SC957R 	SC951R (Insulated Metal Ratchet) 
	SC689R 	SC973R 	SC957R 	SC953R (Axial/In-Line) 
	SC671R 	SC973R 	SC957R 	SC954R (Ratchet) 
	SC781R 	SC974R 	SC959R 	SC957R (Ratchet with lock) 

Needle Holders and Suturing



Extracorporeal	Description	Item No.	Diam.	Length
1/1	Durogrip™ needle holder, straight, tungsten carbide inserts (SC959R handle)	SC550R	5 mm	31 cm
1/1	Durogrip needle holder, curved tungsten carbide inserts (SC959R handle)	SC559R	5 mm	31 cm
1/1	Knot pushing forceps	SC654R SC973R SC958R	5 mm	31 cm
1/1	CROCE/OLMI Dissecting and suture scissors with knot pusher (SC958R handle)	SC022R	5 mm	31 cm
1/1	Knot Pusher	PL651R	5 mm	31 cm
1/1		PL432R	5 mm	31 cm
3/1	Suture hook for intracorporeal tightening of the suture line by pulling on the suture throws in case of continuous anastomosis	SC193R	5 mm	33 cm
1/1	Loop applier, 4.5 mm inner diameter	PL650R	5 mm	15 cm
1/1	Sealing cap, box of 20	PL650250		



Intracorporeal	Description	Item No.	Diam.	Length
1/1	Durogrip™ TC needle holder, straight	PL419R	3.5 mm	20 cm
1/1		PL418R	3.5 mm	29 cm
1/1	Durogrip TC needle holder, straight	PL407R	5 mm	31 cm
1/1		PL404R	5 mm	37 cm
1/1		PL416R	5 mm	42 cm
1/1	Durogrip TC needle holder, curved left	PL408R	5 mm	31 cm
1/1		PL405R	5 mm	37 cm
1/1		PL417R	5 mm	42 cm
1/1	Durogrip TC needle holder, curved right	PL413R	5 mm	31 cm
1/1		PL415R	5 mm	37 cm
1/1	"The Viper" Durogrip TC suture Assistant/ needle holder, 2 x 3 Teeth	PL409R	5 mm	31 cm
1/1	Super righting needle holder	PL414R	5 mm	31 cm
1/1	Durogrip TC needle holder, fenestrated	PL410R	5 mm	31 cm
1/1	Durogrip TC needle holder, crimped/ fenestrated	PL411R	5 mm	31 cm



Cinch Organ Retractor

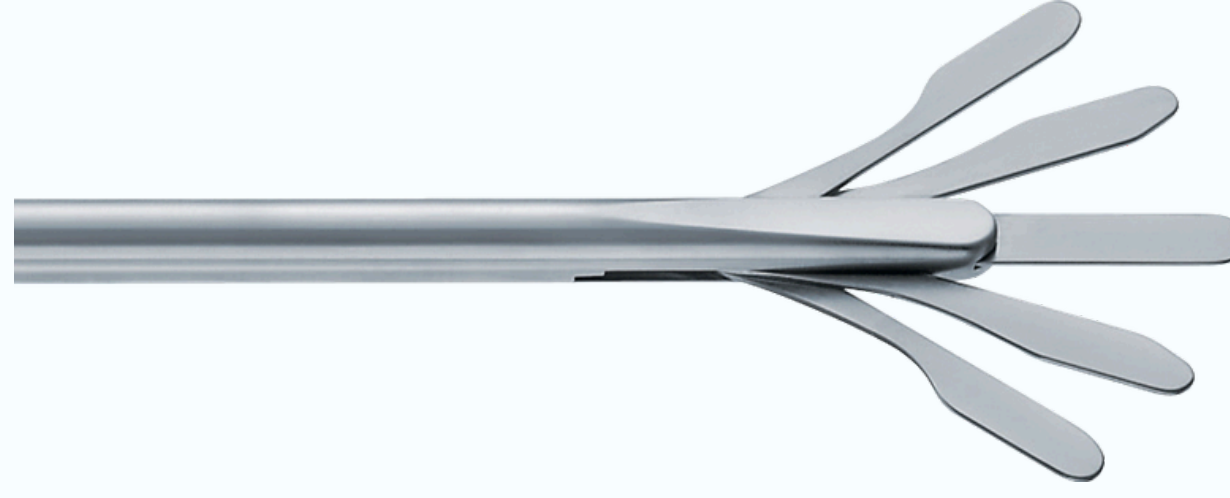

Components	Description	Item No.
	Reusable atraumatic clip, 5.00 N (510 g) closing force	PL593R
	Siliconering with needle, sterile, single-use, box of 12 All components of packaging are latex free.	PL595SU
	Articulating clip applicator/remover, 12.5 mm, 35 cm	PL530R
	Fixed clip applicator/remover, 12.5 mm, 35 cm	PL531R

Retractors

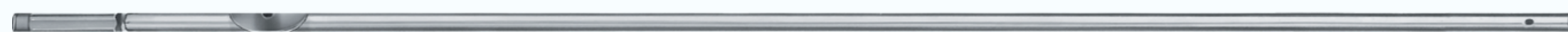
Description	Item No.	Diam.	Length
 Fan retractor	PL680R	10 mm	40 cm
 Prostate retractor	PL682R	10 mm	37 cm

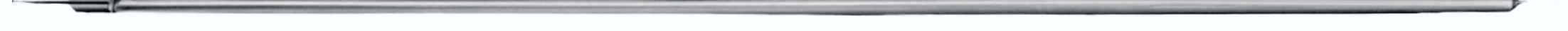
Suction / Irrigation

Description	Item No.	Diameter	Length
Suction/irrigation tube with finger valve, luer-lock connection 	GF320R	5 mm	33 cm
Suction/Irrigation Tube, Luer-Lock connection 	GF321R	5 mm	33 cm
Puncture needle with finger valve, luer-lock connection, 2 mm (12 gauge) distal tip diameter 	SR553R	5 mm	45 cm
Injection cannula, straight, distal tip diameter 0.8 mm 	SR554R	5 mm	37 cm

Description	Item No.	Diam.	Length
Suction irrigation tube with two-way-stopcock 	PG027R	5 mm	33 cm
Suction irrigation tube with trumpet valve 	GF324R	5 mm	30 cm
Suction irrigation tube with trumpet valve 	GF325R	10 mm	40 cm

LIGATION INSTRUMENTS

A dedicated collection of instruments for secure vessel and duct occlusion during surgery. Includes ligature carriers (Deschamps), clip applicators and clips, aneurysm needles, and ligature-passing forceps. Designed for precise placement of sutures or clips around deep or delicate structures, with fine tips, smooth jaws, and ergonomic handles to ensure reliable knotting or clipping with minimal tissue trauma. Crafted from premium stainless steel for durability and corrosion resistance.

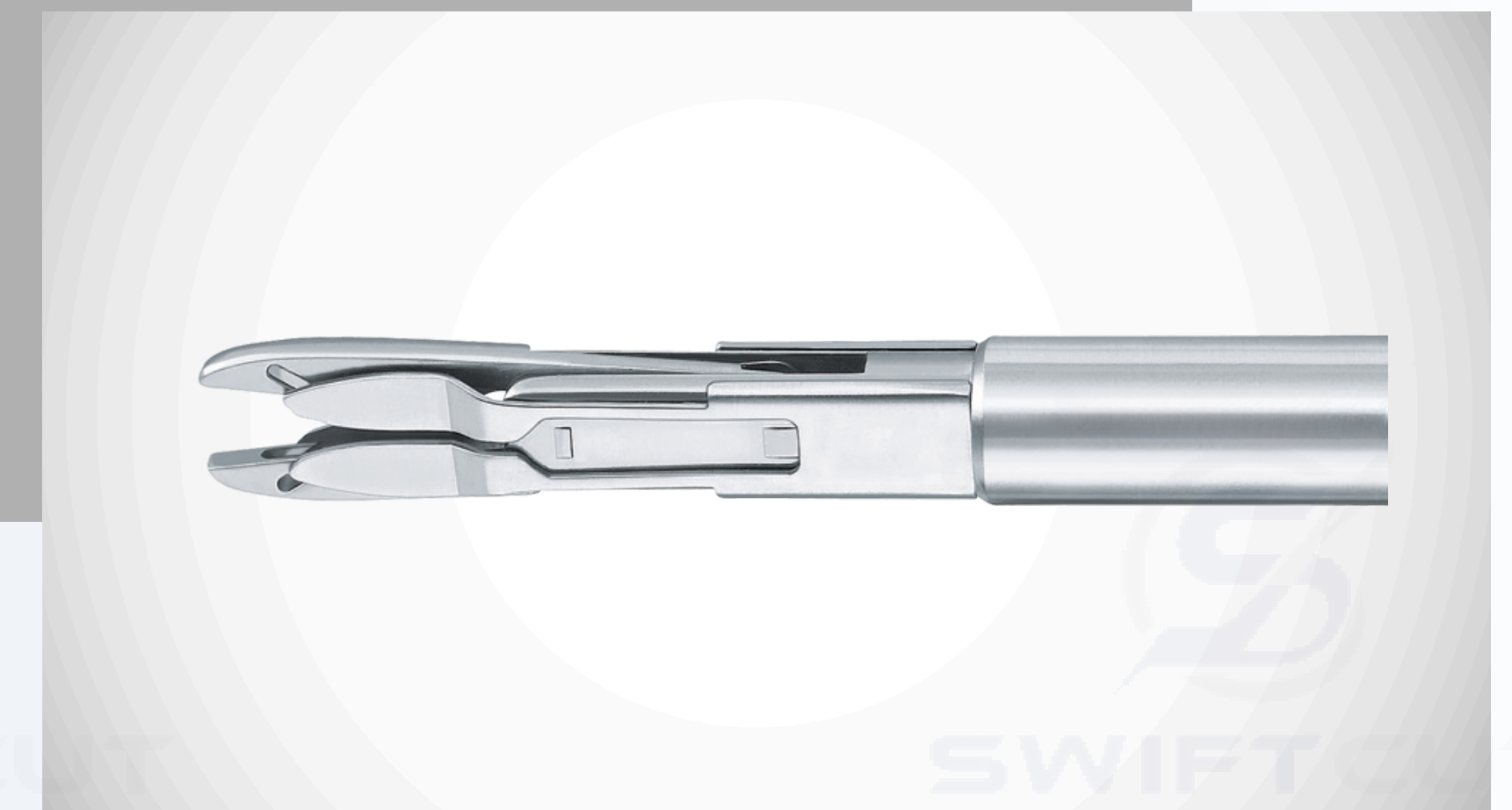
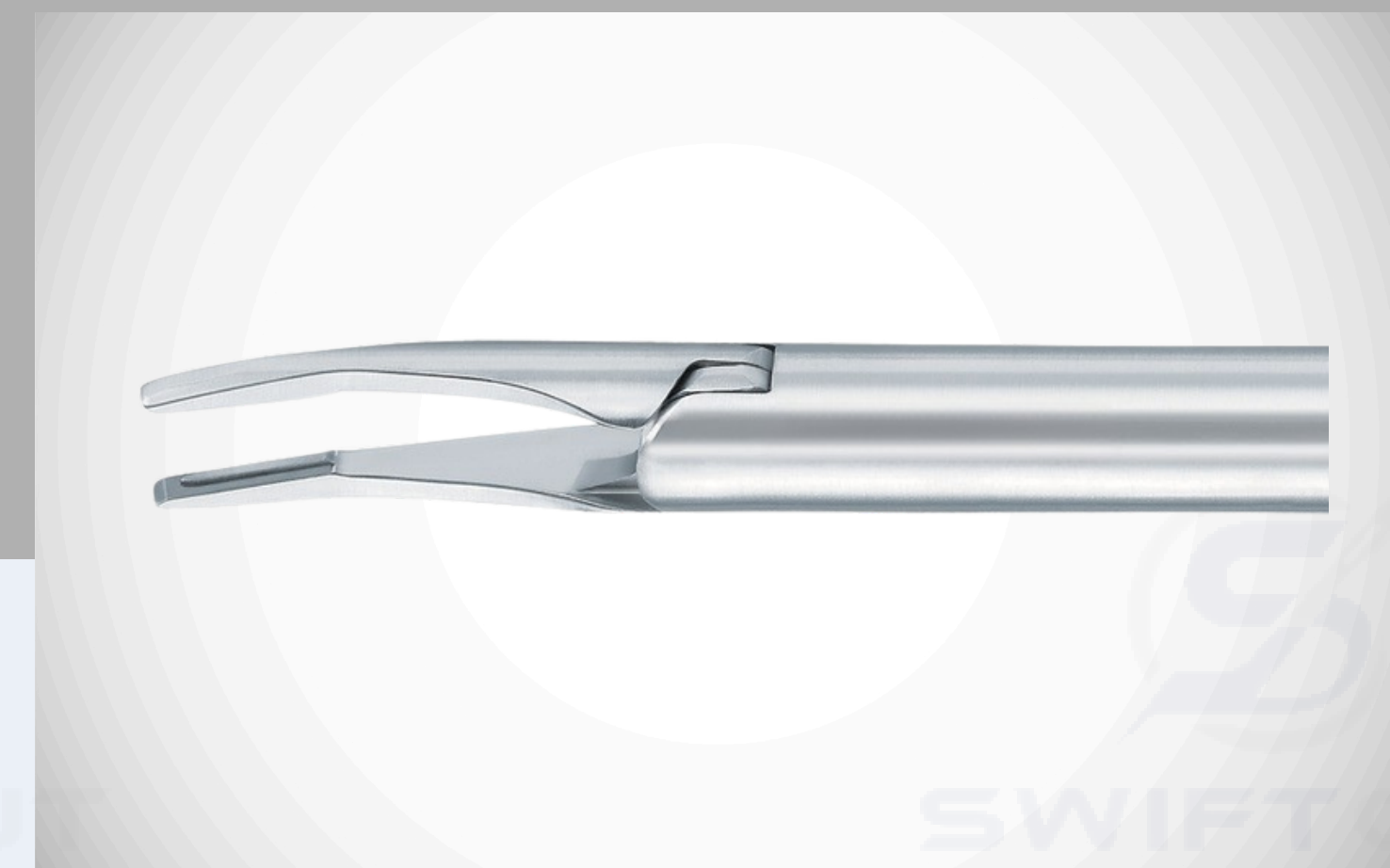
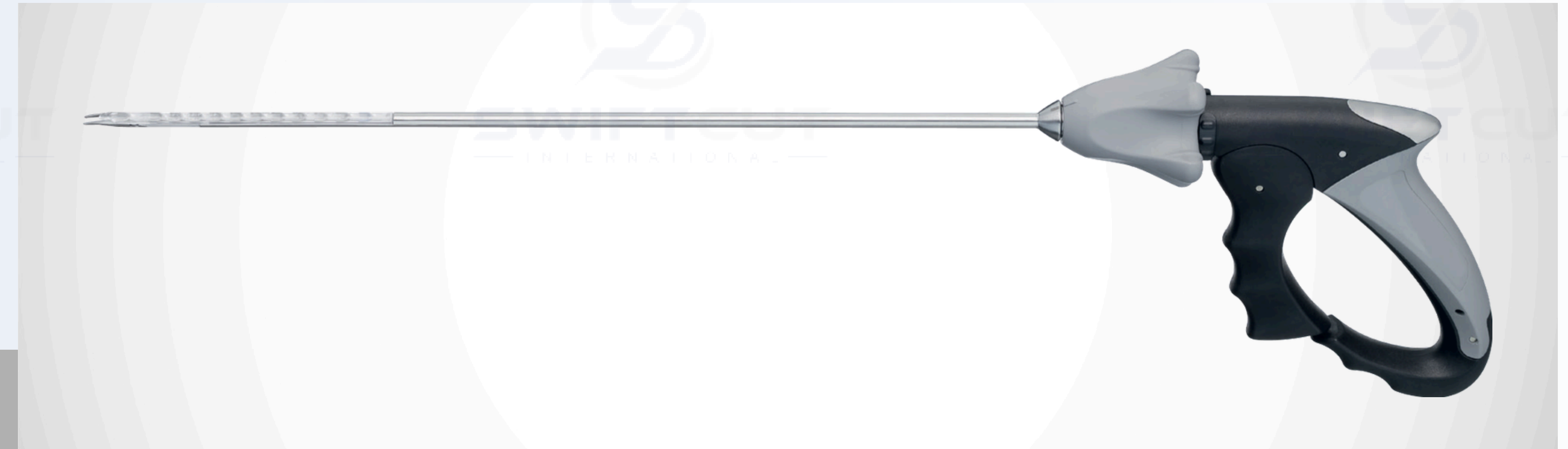

Clip Applicators and Removal Forceps

Laparoscopic Clip Applicators

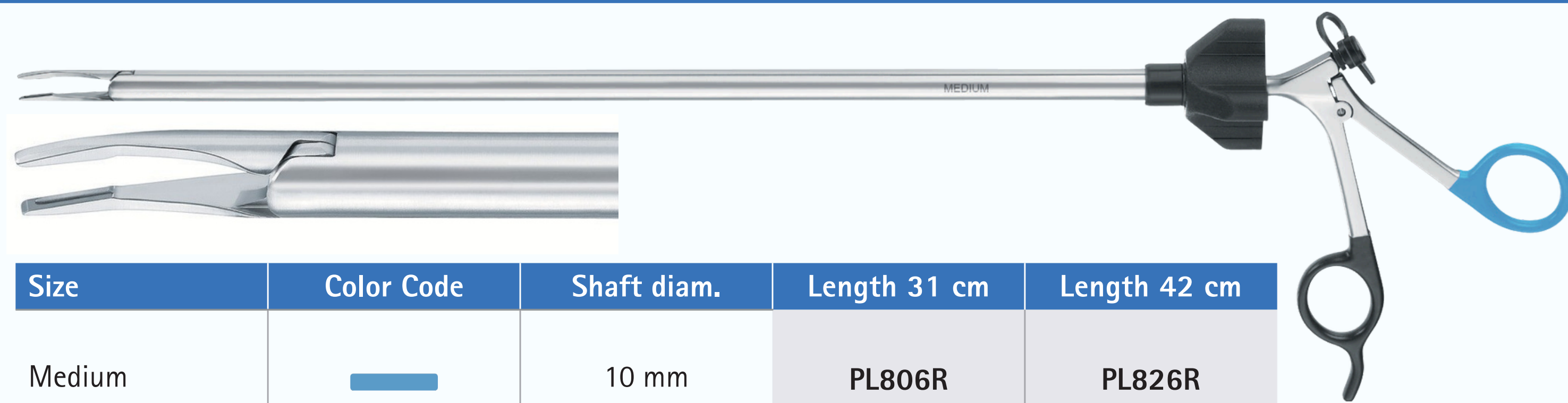

Size	Color Code	Shaft diam.	Length 31 cm	Length 42 cm
Medium		10 mm	PL806R	PL826R
Medium-Large		10 mm	PL807R	PL827R

Laparoscopic Clip Removal Forceps



Size	Color Code	Shaft diam.	Length 31 cm
Medium		10 mm	PL816R
Medium-Large		10 mm	PL817R

Ti-P Multi-Fire Clip Applier

Medium-Large (ML)	Description	Item No.	Diameter	Length
	Clip applier, Medium-Large (ML)	PL606R	10 mm	37 cm
		PL608R	10 mm	26 cm

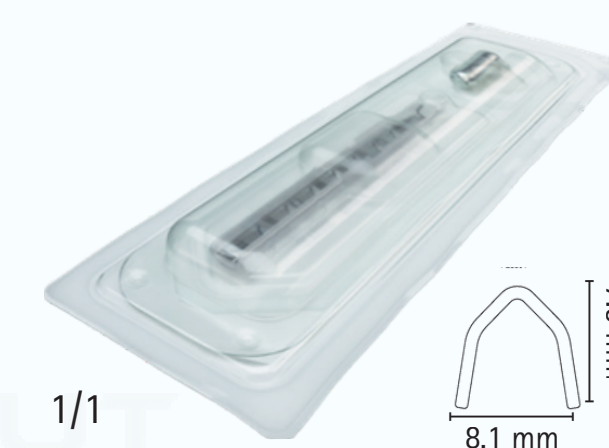
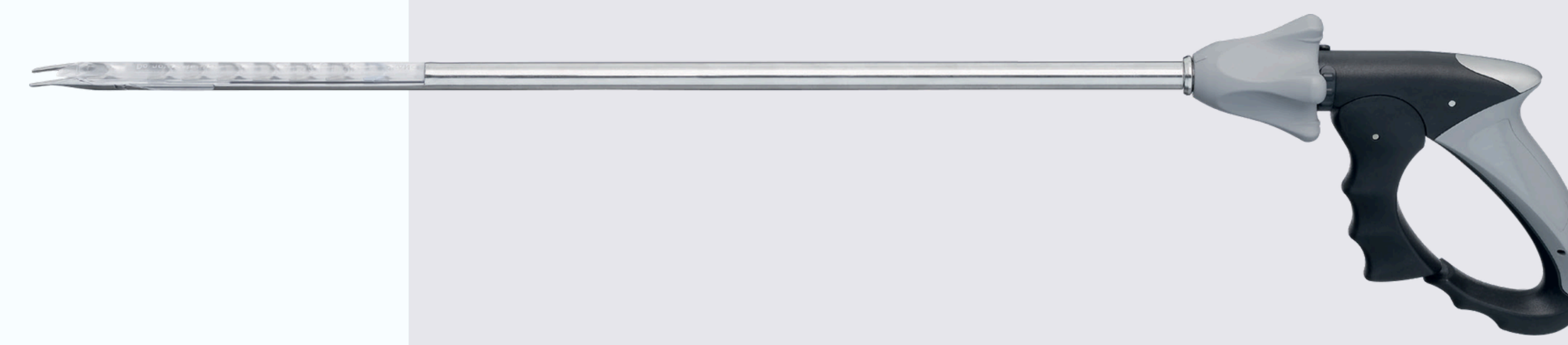

Medium-Large (ML) clips for use with 10 mm clip applicators, 12 sterile clip cartridges per box, 8 titanium clips and 1 CO₂ cylinder per cartridge

PL579T

Small-Medium (SM)	Description	Item No.	Diameter	Length
	Clip applier, Small-Medium (SM)	PL604R	5 mm	31 cm
		PL603R	5 mm	20.5 cm

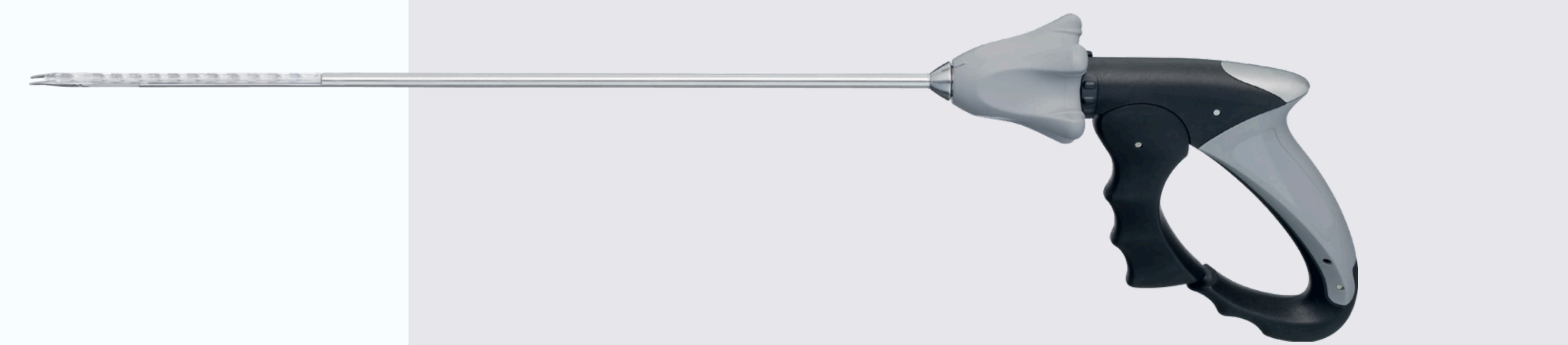

Small-Medium (SM) clips for use with 5 mm clip applicators 12 sterile clip cartridges per box, 12 titanium clips and 1 CO₂ cylinder per cartridge

PL574T

ACCESS & CLOSURE

A complete range of instruments for initial surgical entry and final wound approximation. Includes scalpels, surgical blades, retractors for exposure, needle holders, suture materials, skin staplers, and adhesive wound closure strips. Designed to deliver clean, precise incisions and secure, reliable closure of tissue layers. Ergonomic grips, balanced designs, and premium-grade materials ensure efficient workflow and optimal patient outcomes from the first cut to the final dressing.

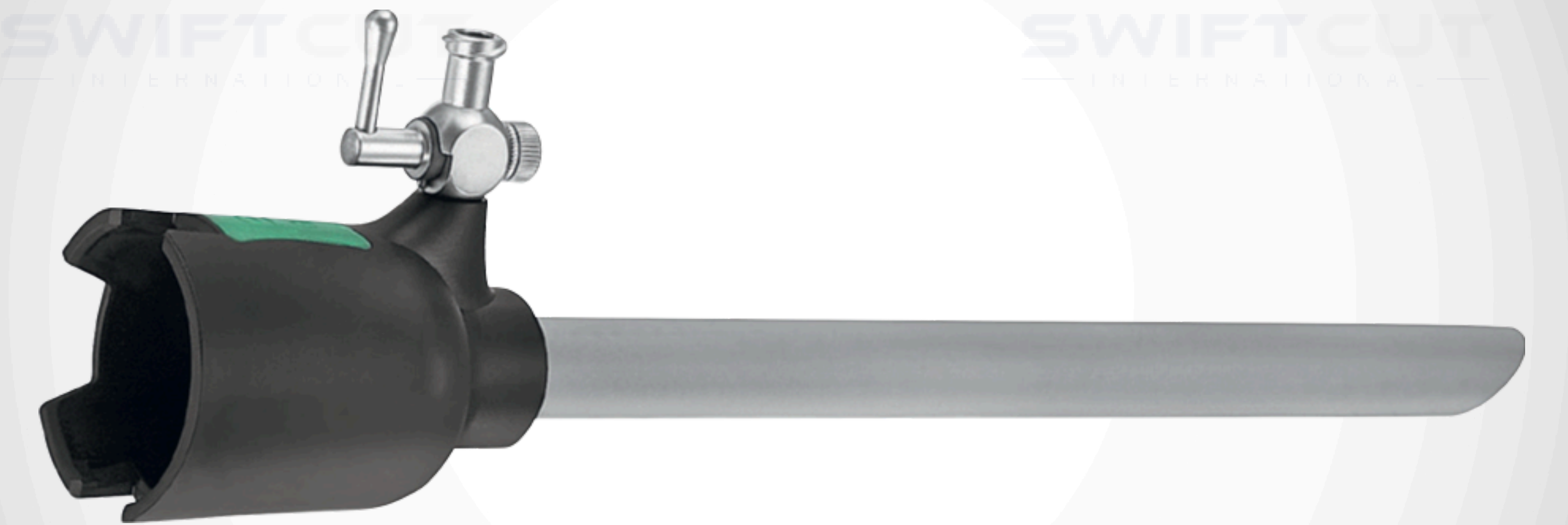

Access Instruments

Description	Item No.	Diam.	Length
VERESS needle, single use, box of 20	EJ995	2.1 mm	120 mm
	EJ996	2.1 mm	150 mm



VERESS needle with 1.6 mm (14 gauge) distal tip diameter	PG003	2.1 mm	100 mm
	PG008	2.1 mm	120 mm
	PG011	2.1 mm	150 mm

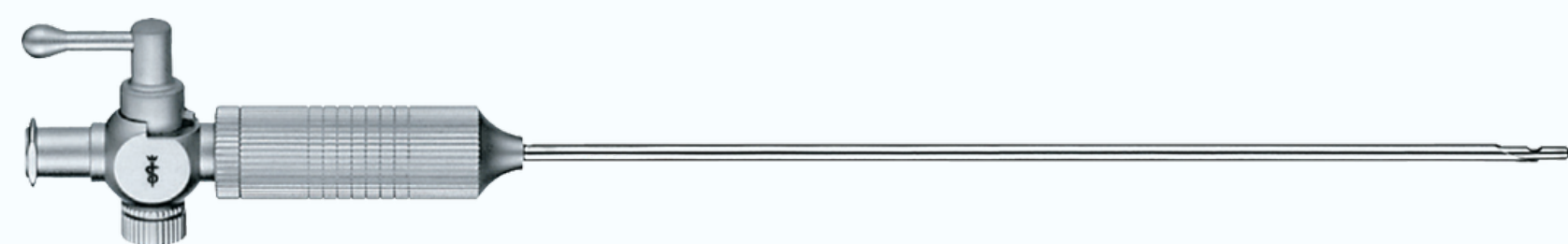

Exploratory probe with scaling	BN320R	5 mm	40 cm
	BN321R	5 mm	50 cm
Exploratory probe with scaling	BN322R	3.5 mm	40 cm



Insufflation

Description	Item No.
Disposable tube set incl. CO2 filter, sterile, 10 ft., box of 10	PG012

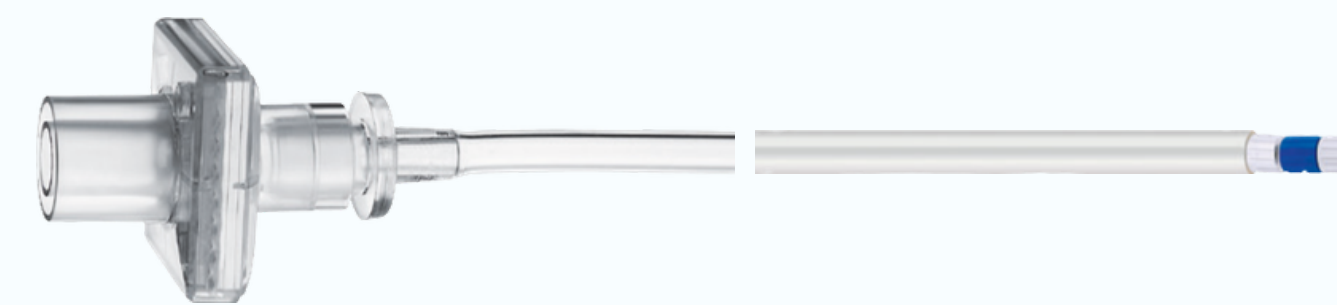

Disposable CO2 filter, sterile, box of 25	PG019
---	-------

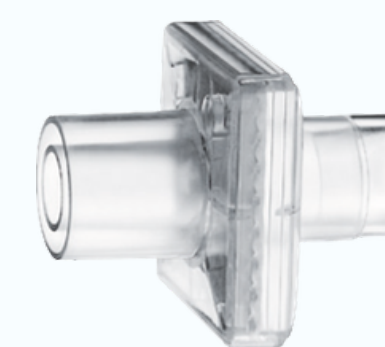

3.5 mm Trocars

Sleeves

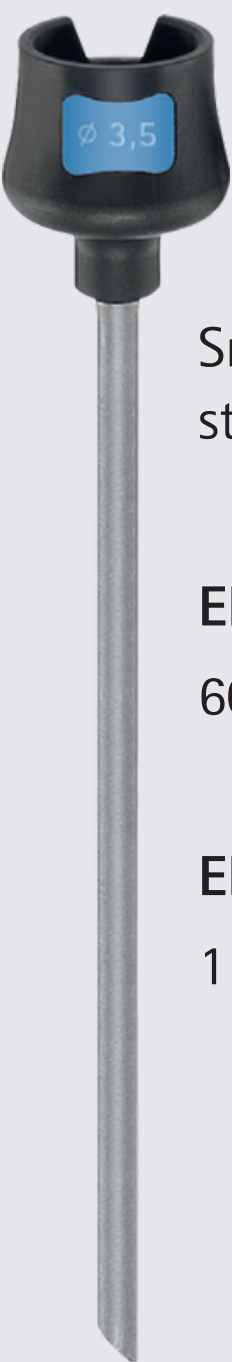

Smooth, without stopcock

EK311R
60 mm

EK315R
110 mm

Sleeves



Smooth, with stopcock

Inner diameter of EK310R and EK314R is enlarged for optimized insufflation, insertion of needles and 4 mm scopes.

EK310R
60 mm

EK314R
110 mm

Obturator



Conical sharp
For use with non-insufflation sleeves
EK311R & EK315R

EK345R
60 mm

EK346R
110 mm



Conical blunt
For use with non-insufflation sleeves
EK311R & EK315R

EK348R
60 mm

EK349R
110 mm

Obturator

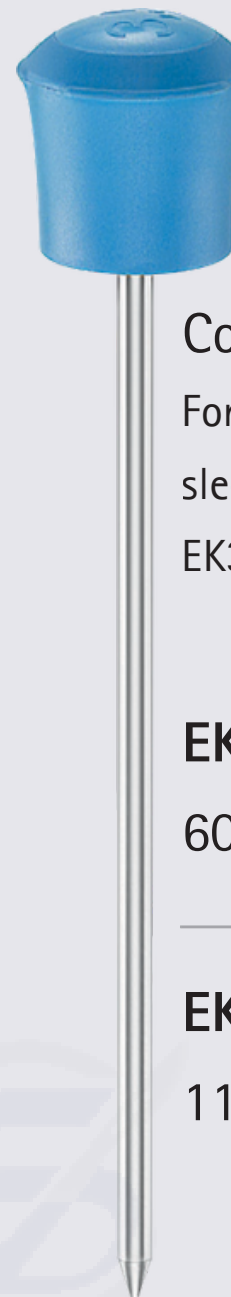

Conical sharp
For use with insufflation sleeves
EK310R & EK314R

EK355R
60 mm

EK356R
110 mm

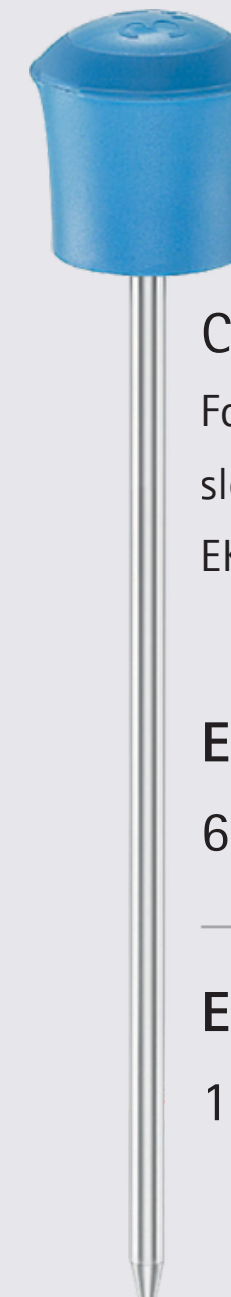

Conical blunt
For use with insufflation sleeves
EK310R & EK314R

EK358R
60 mm

EK359R
110 mm

 **EK380P**
Sealing unit for 3.5 mm trocars, box of 20

5 mm Trocars

Sleeves



Smooth, with stopcock

EK010R
60 mm

EK014R
110 mm

EK018R
150 mm



Smooth, without stopcock

EK011R
60 mm

EK015R
110 mm



Threaded, with stopcock

EK012R
60 mm

EK016R
110 mm



Threaded, without stopcock

EK013R
60 mm

EK017R
110 mm

 **EK080P**
Sealing unit for 5 mm trocars, box of 20

 **EK001SU**
Single-use sealing unit for 5 mm trocars, box of 20

Obturator



Conical Sharp

EK045R
60 mm

EK046R
110 mm

EK047R
150 mm



Conical Blunt

EK048R
60 mm

EK049R
110 mm

EK050R
150 mm



Triangular Sharp

EK051R
60 mm

EK052R
110 mm

EK053R
150 mm



Dilating

EK148SU
60 mm

EK149SU
110 mm

EK150SU
150 mm

Single-use, sterile (box of 6)

10 mm Trocars

Sleeves

 Smooth, with stopcock EK024R 110 mm	 Smooth, without stopcock EK025R 110 mm	 Threaded, with stopcock EK026R 110 mm	 Threaded, without stopcock EK027R 110 mm
 EK028R 150 mm			

 **EK083P**
Sealing unit for 10/12 mm trocars with 5 mm Flap Converter

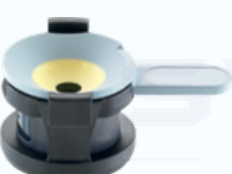
 **EK086P**
Sealing unit for 10/12 mm trocars



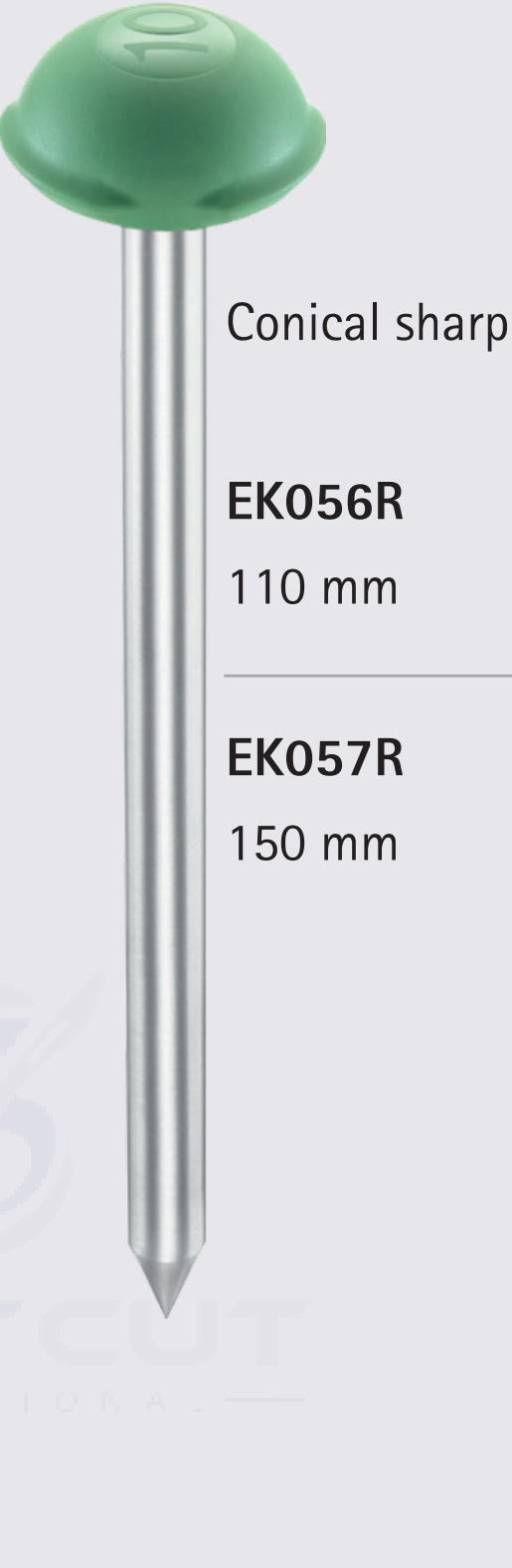

 **EK002SU**
Single-use universal sealing unit for 10/12 mm trocars
Box of 20

Obturator

 Conical sharp EK056R 110 mm	 Conical blunt EK059R 110 mm	 Triangular sharp EK062R 110 mm	 Dilating EK159SU 110 mm
 EK057R 150 mm	 EK060R 150 mm	 EK063R 150 mm	 EK160SU 150 mm
Single-use, sterile (box of 6)			

12 mm Trocars

Sleeves

 Smooth, with stopcock EK034R 110 mm	 Smooth, without stopcock EK035R 110 mm	 Threaded, with stopcock EK036R 110 mm	 Threaded, without stopcock EK037R 110 mm
 EK038R 150 mm			

 **EK083P**
Sealing unit for 10/12 mm trocars with 5 mm flap converter

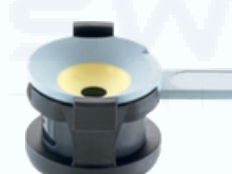
 **EK086P**
Sealing unit for 10/12 mm trocars

 **EK002SU**
Single-use universal sealing unit for 10/12 mm trocars
box of 20

Obturator

 Conical sharp EK066R 110 mm	 Conical blunt EK069R 110 mm	 Triangular sharp EK072R 110 mm	 Dilating EK169SU 110 mm
 EK067R 150 mm	 EK070R 150 mm	 EK073R 150 mm	 EK170SU 150 mm
Single-use, sterile (box of 6)			

Flexible Trocars



Flexible Trocars

- Flexible trocar sleeve allows insertion of curved instruments and specialty jaw patterns
- Available in two different diameters:
 - 7 mm for use with 5 mm instruments
 - 13 mm for use with 5 mm and 10 mm instruments

7 mm	13 mm
 <p>EJ800R Complete trocar includes: obturator, cannula and valve, 7 mm x 100 mm</p>	 <p>EJ590R Complete trocar includes: obturator, cannula and valve, 13 mm x 100 mm</p>



EJ804P	Flexible cannula for 7 mm trocars, 75 mm length, box of 3
EJ806P	Flexible cannula for 7 mm trocars, 100 mm length, box of 3
EJ824P	Flexible cannula for 13 mm trocars, 75 mm length, box of 3
EJ826P	Flexible cannula for 13 mm trocars, 100 mm length, box of 3



DEDICATED
SALES
TEAM

CONTACT US NOW!

FOR EXCEPTIONAL CUSTOMER CARE.

- DETAILS ✓
- QUOTATION ✓
- VIRTUAL MEETING ✓
- ORDER ✓

CONTACT US NOW!

Location: 
Shahabpura, Sialkot, Pakistan

Website: 
www.swiftcutint.com

Email: 
info@swiftcutint.com

Phone Number: 
+92 305 91976121