

INTESTINAL INSTRUMENTS

A specialized range of instruments for gastrointestinal and bowel surgery. Includes atraumatic intestinal clamps (such as Doyen and Kocher), anastomosis forceps, angled scissors, bowel-holding forceps, and needle holders. Designed to minimize tissue trauma, ensure secure occlusion during resection and anastomosis, and provide optimal access to deep abdominal structures. Precision jaws, ratcheted controls, and ergonomic handles deliver reliable, controlled performance.



Desjardin Gall Stone Forceps

Screw joint

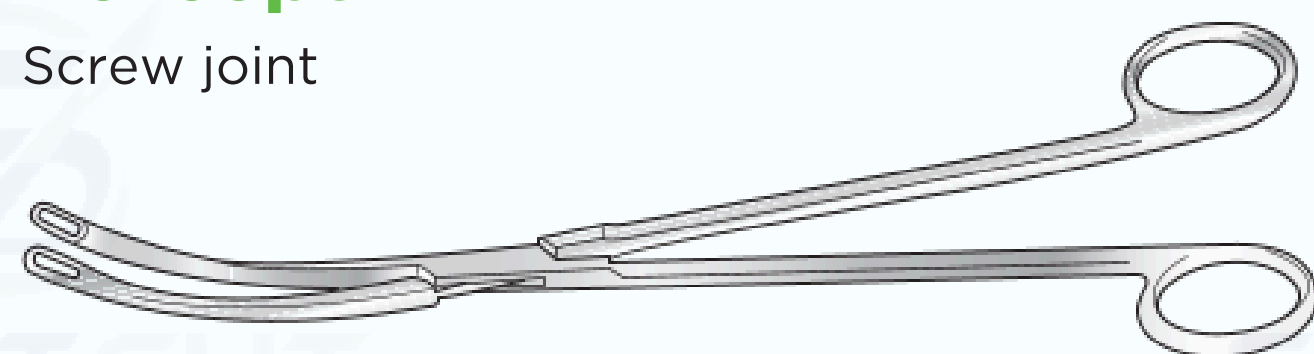

SC-IN/001a	Small, 220mm long
SC-IN/001b	Large, 238mm long

Lane Stomach Holding Forceps

Straight, serrated jaws, screw joint

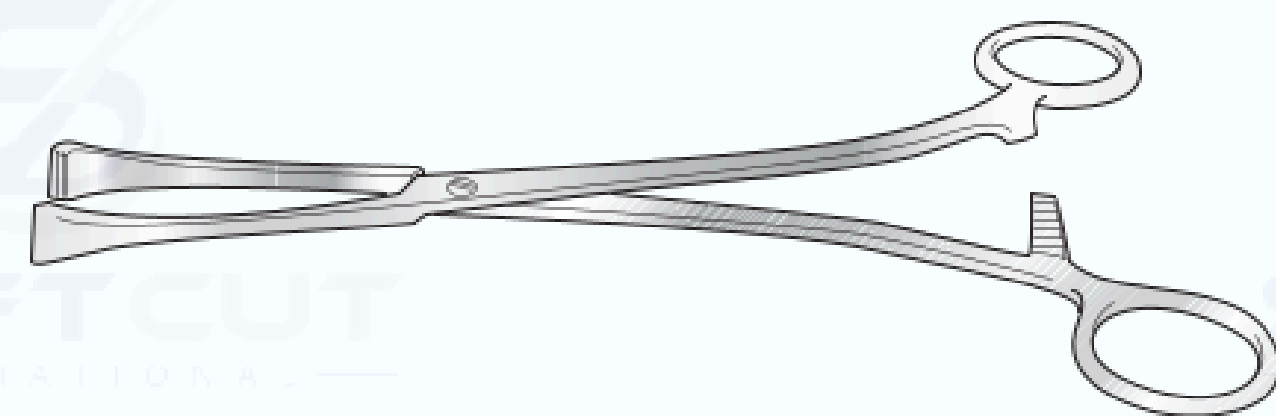

SC-IN/008	203mm long
-----------	------------

Moynihan Cholecystectomy Forceps

Curved on flat, screw joint

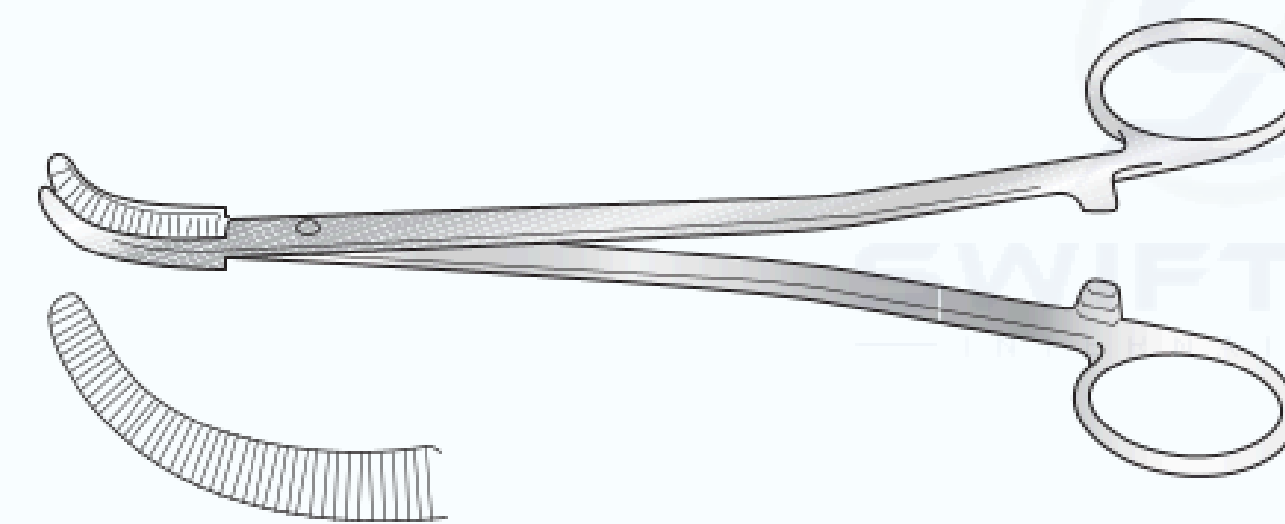

SC-IN/012	215mm long
-----------	------------

Kocher Intestinal Forceps

With light spring blades and longitudinal serrations

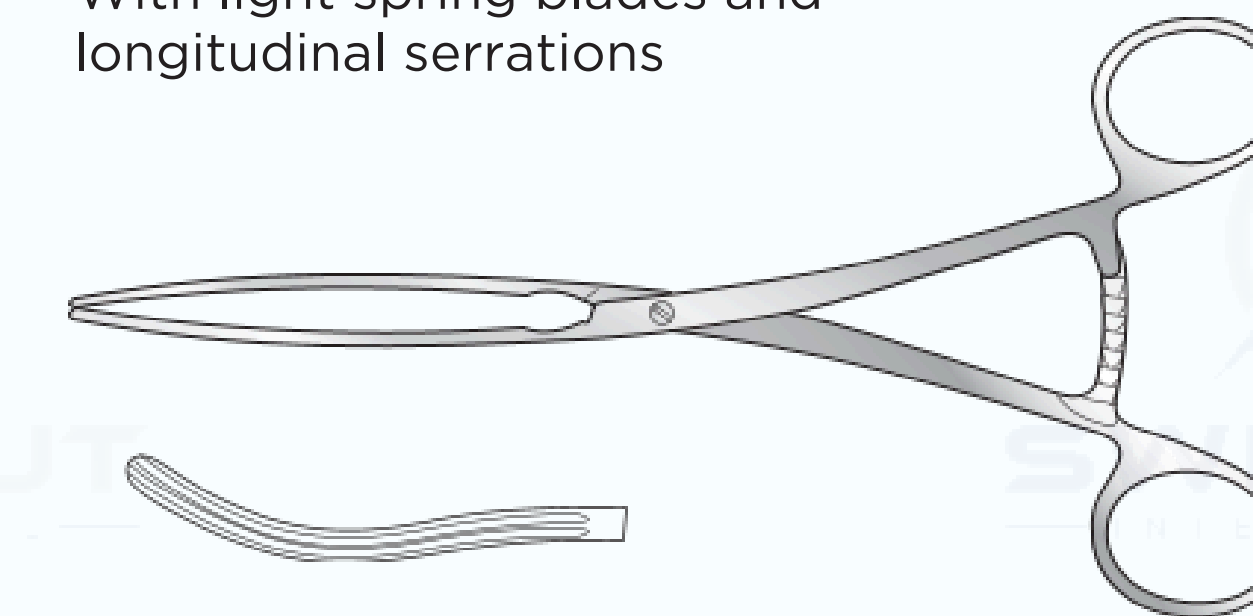

SC-IN/015a	Straight, 90mm blades, 210mm long
SC-IN/015b	Curved, 85mm blades, 210mm long

Babcock Intestinal Forceps

Straight, extra light

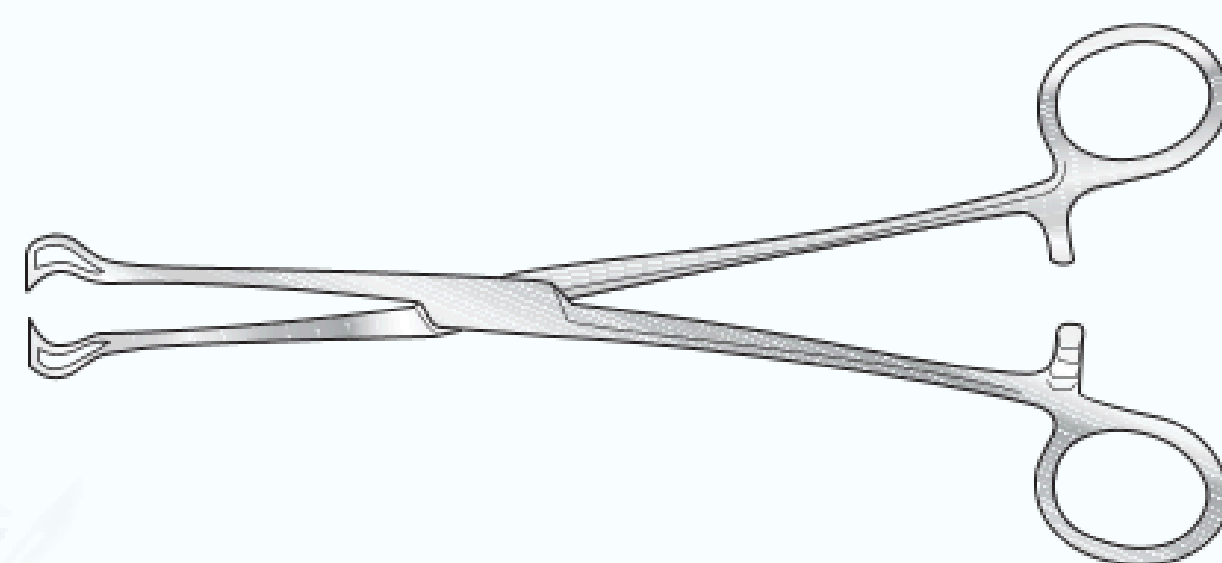

SC-GI/278	203mm long
-----------	------------

Lahey Cholecystectomy Forceps

Curved, longitudinal serrations, heavier pattern

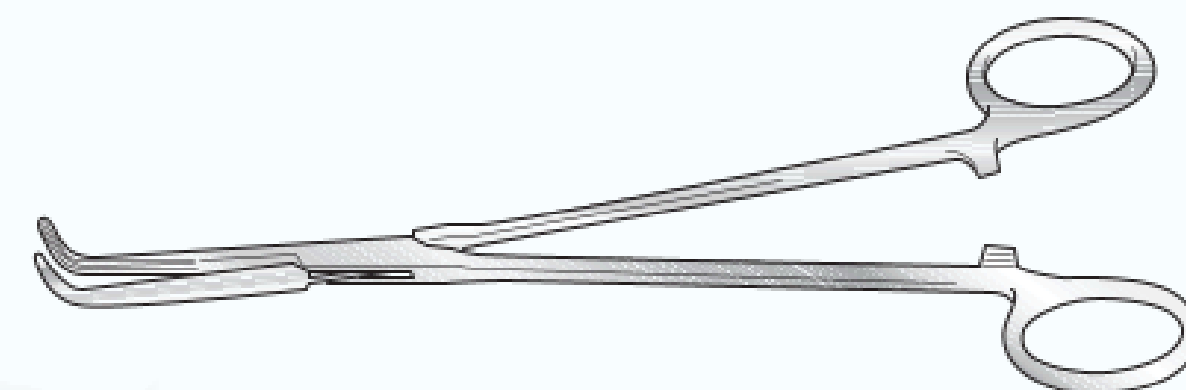

SC-IN/011	76mm blades, 197mm long
SC-IN/011a	225mm long

Lane Intestinal Forceps

110mm blades, longitudinal serrations
240mm long

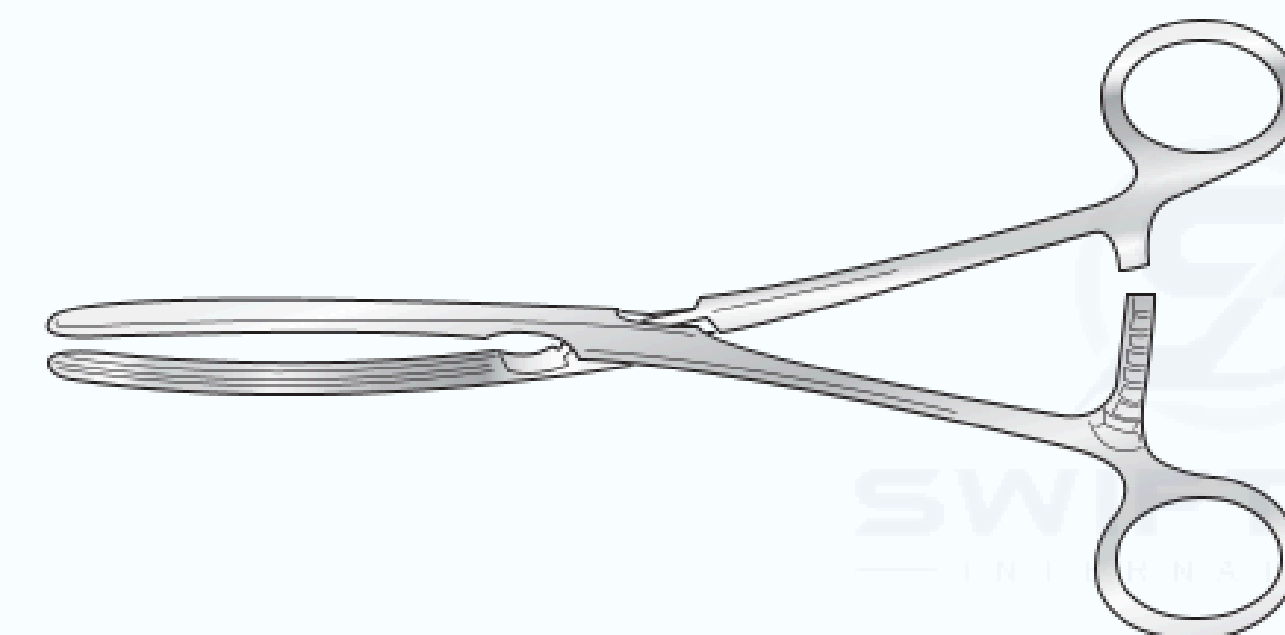

SC-IN/013	Straight
SC-IN/013b	Curved

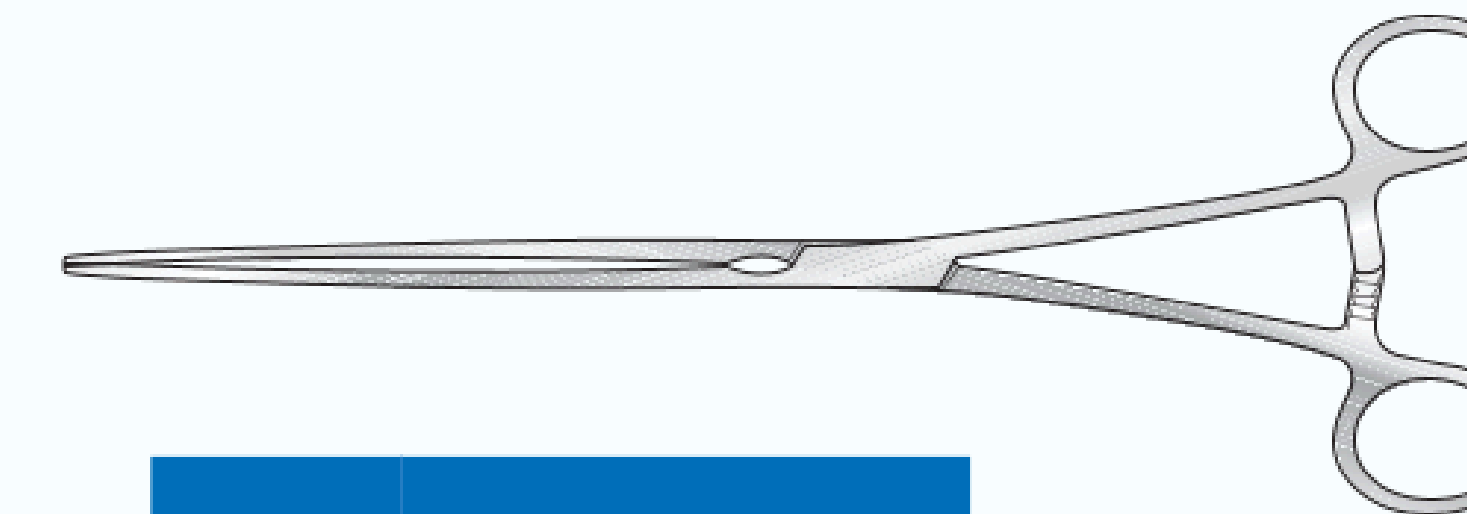

SC-IN/015c	Straight, 120mm blades, 250mm long
SC-IN/015d	Curved, 1150mm blades, 250mm long
SC-IN/015e	Straight, 150mm blades, 250mm long
SC-IN/015f	Curved, 145mm blades, 250mm long

Maingot Intestinal Forceps

Straight, serrated tip, fenestrated grip



SC-IN/006	203mm long
-----------	------------

Lahey Sweet Forceps

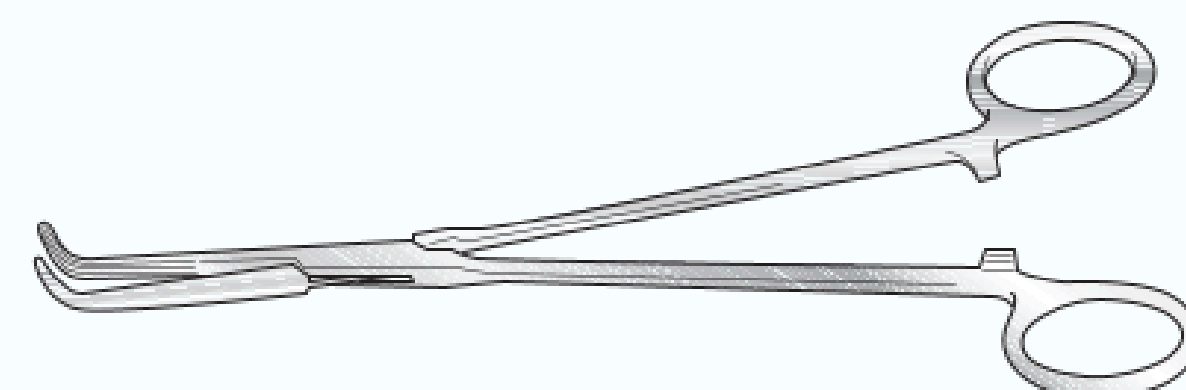

SC-IN/011b	200mm long
SC-IN/011c	225mm long
SC-IN/011d	230mm long

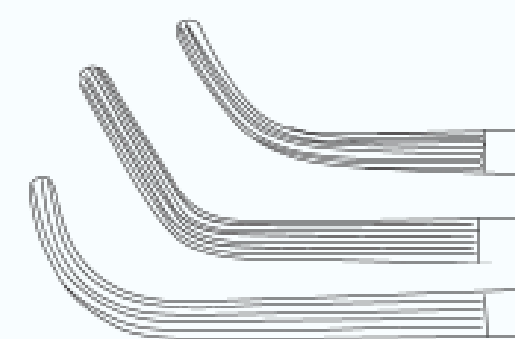

Denis Browne Intestinal Forceps

Straight, serrated tips, fenestrated jaws



SC-IN/007	178mm long
-----------	------------

Seton Pringle Intestinal Forceps

Straight, longitudinal serrations
178mm long

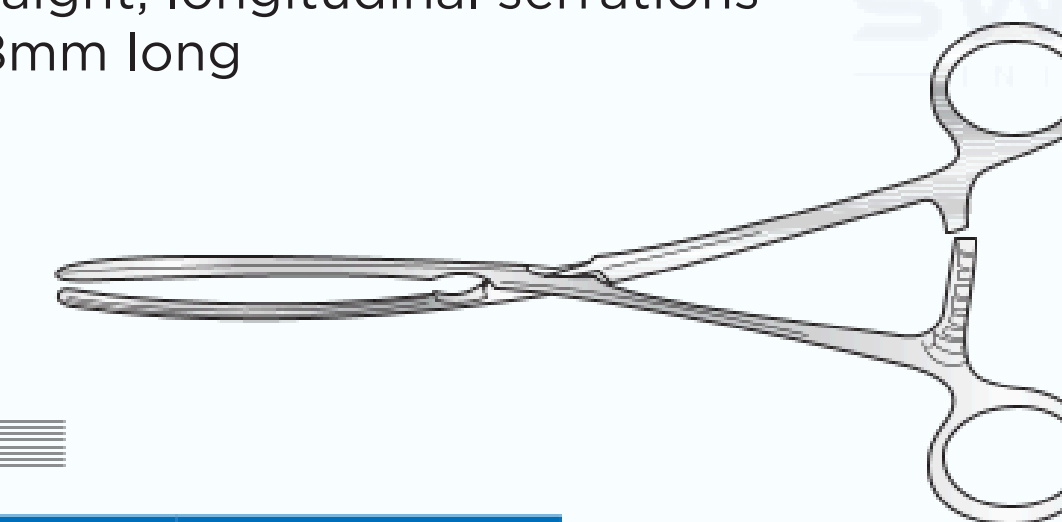

SC-IN/014	Fine blades 2.5mm wide
-----------	------------------------

Lang Stevenson Intestinal Forceps

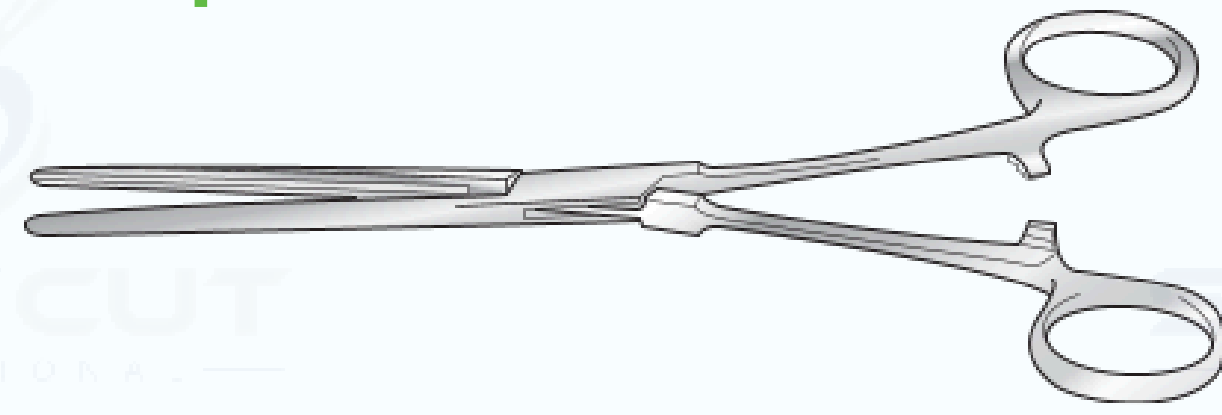

SC-IN/018	82mm jaw, keyed blades, 203mm long
-----------	------------------------------------



Schoemaker-Ogilvie Colectomy Forceps

Straight, hollow blades

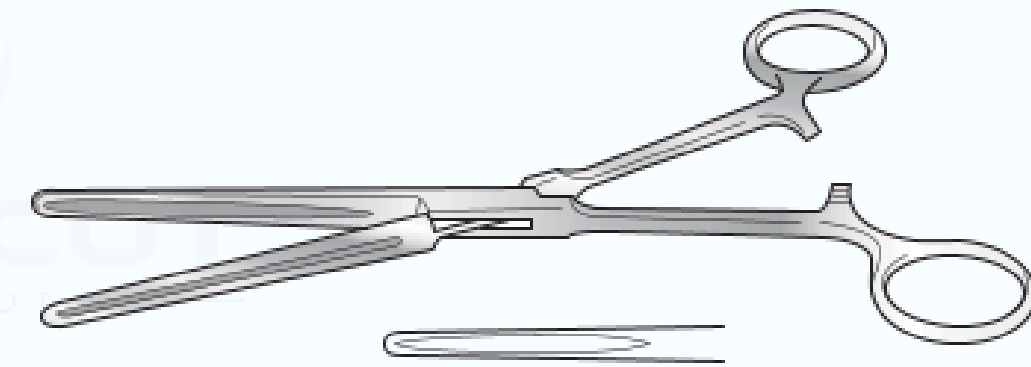

SC-IN/020	171mm long
SC-IN/020a	203mm long

Doyen Intestinal Clamp

240mm long

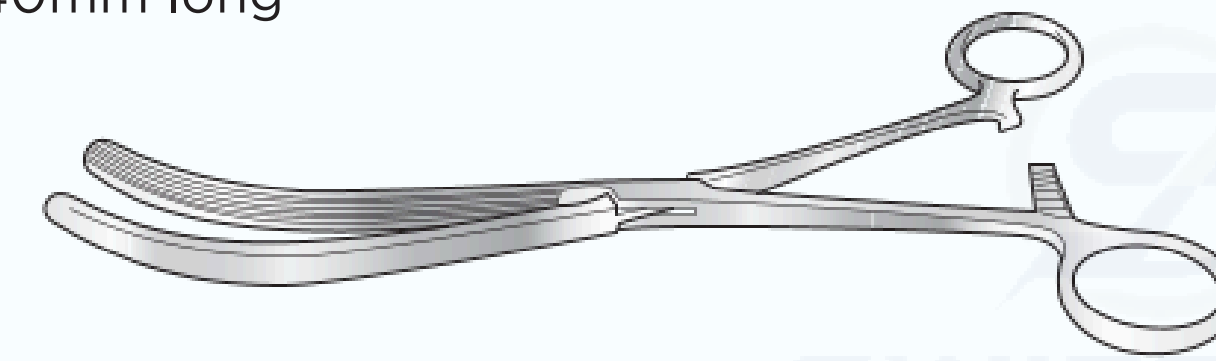

SC-IN/004a	Straight
SC-IN/004b	Curved

Zachary Cope Anastomosis Clamp

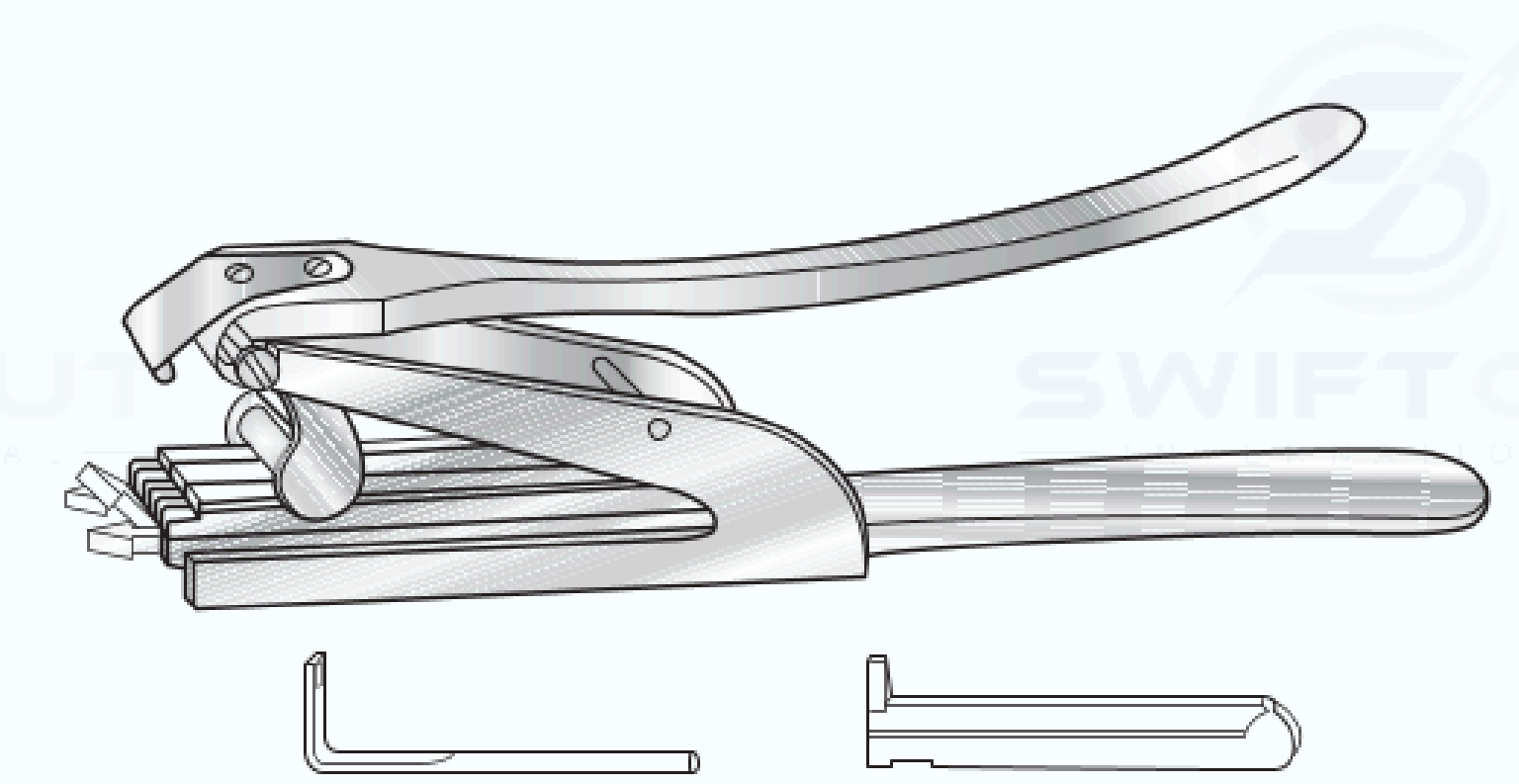

SC-IN/010a	Set: 3 clamps, lever action closing device and tommy bar, 233mm long
SC-IN/010b	Set of 3 clamps
SC-IN/010c	Tommy bar for set, 103mm long

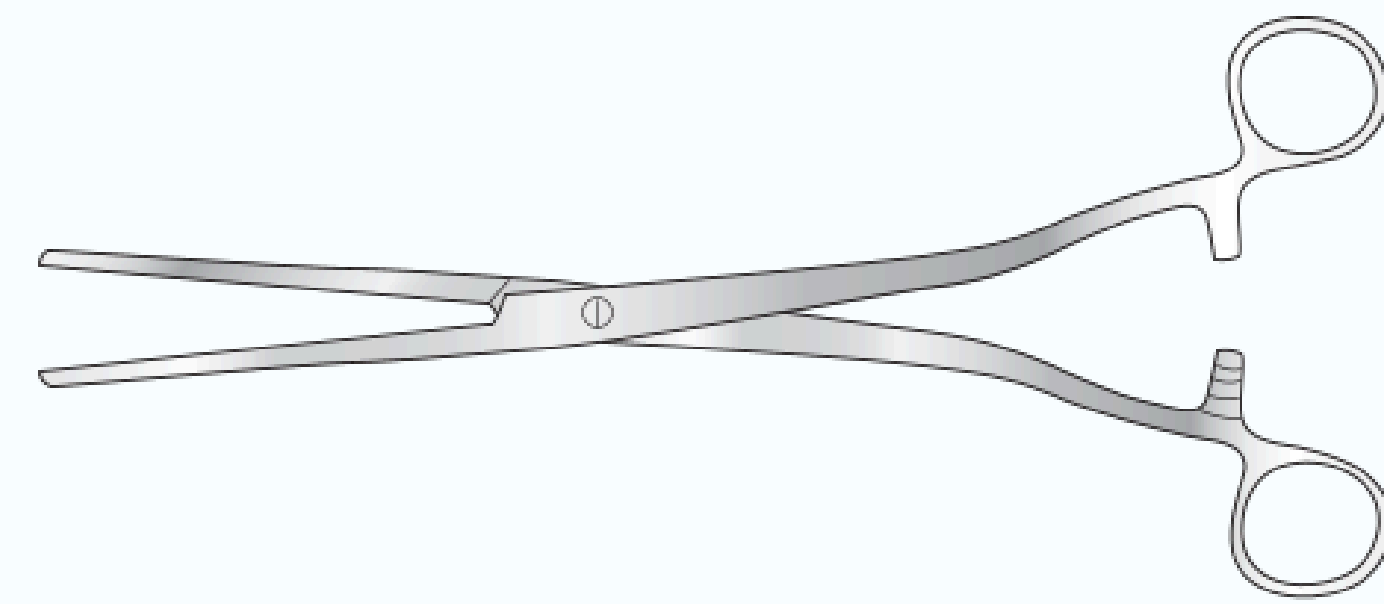

Hartman Intestinal Clamp

With diagonal serrations, 200mm long

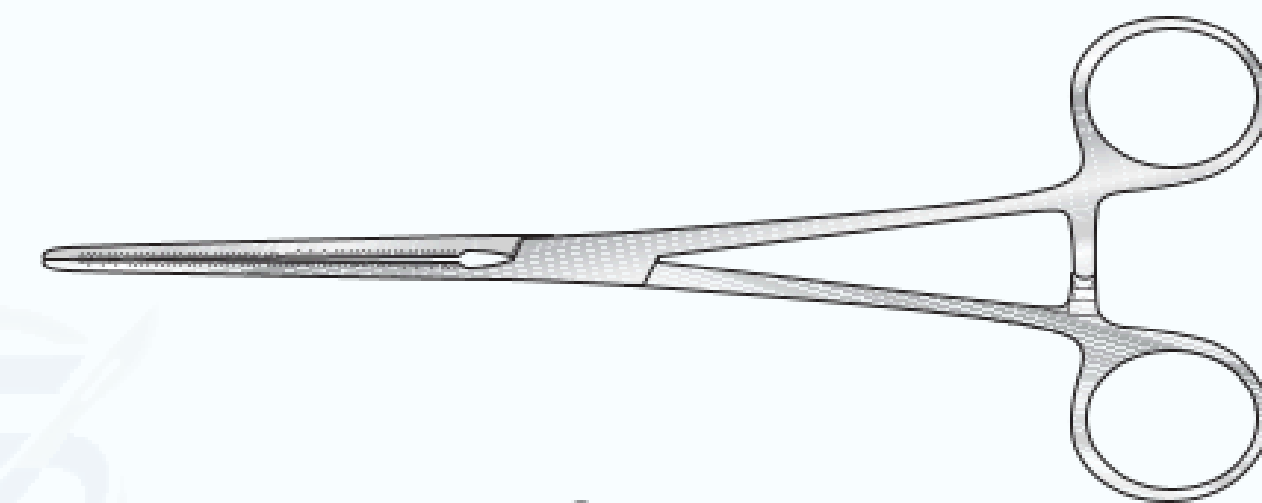

Lane Twin Stomach Clamp

Longitudinal serrations large, 150mm blades, 305mm long

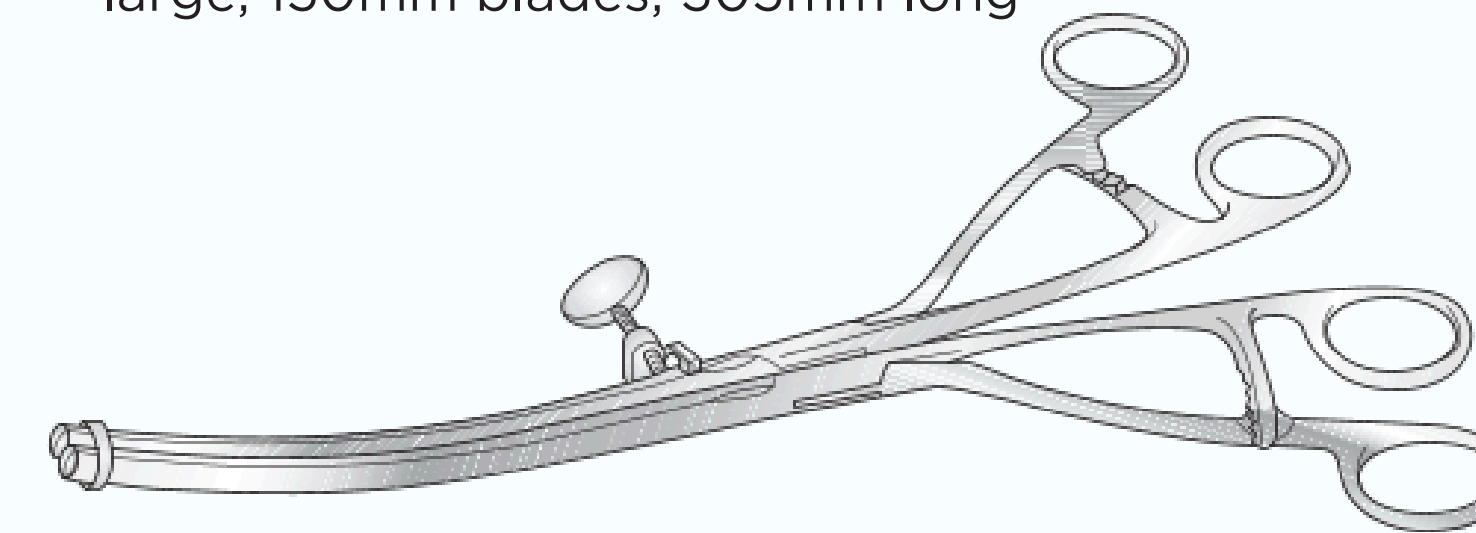

SC-IN/009b	Straight
SC-IN/009a	Curved

Parker Kerr Intestinal Forceps/Clamp

Blades 89mm, 254mm long

SC-IN/017a	Curved
SC-IN/017c	Straight



SC-IN/015g	Straight
SC-IN/015h	Curved

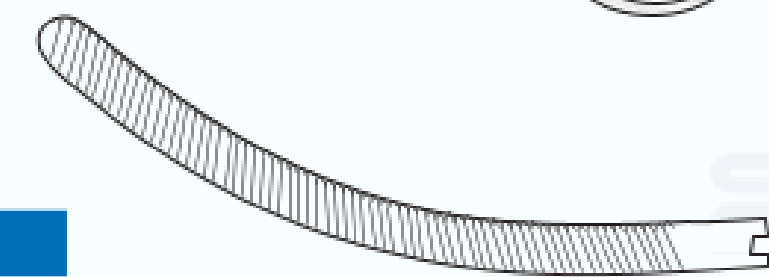

Bakes Bile Duct Dilators

Malleable stems, 203mm long

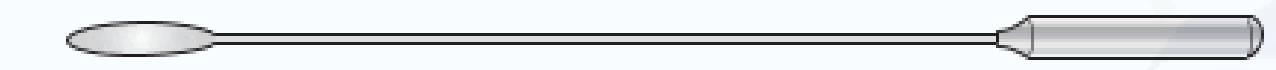

SC-IN/016a	Set of nine
SC-IN/016c	3mm ø head
SC-IN/016d	4mm ø head
SC-IN/016e	5mm ø head
SC-IN/016f	6mm ø head

SC-IN/016g	7mm ø head
SC-IN/016h	8mm ø head
SC-IN/016i	9mm ø head
SC-IN/016j	10mm ø head
SC-IN/016k	11mm ø head

Guard/Shoe

SC-IN/017b curved, fenestrated inner or outer curve, 89mm

SC-IN/017d	Straight, 89mm
------------	----------------

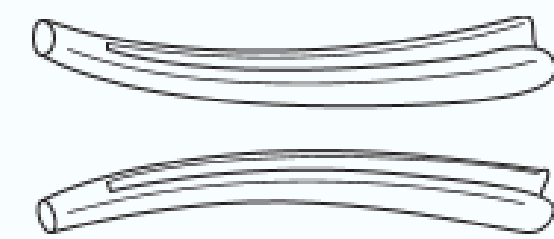

Payr Intestinal Clamp

Crushing, lever action, longitudinal serrations

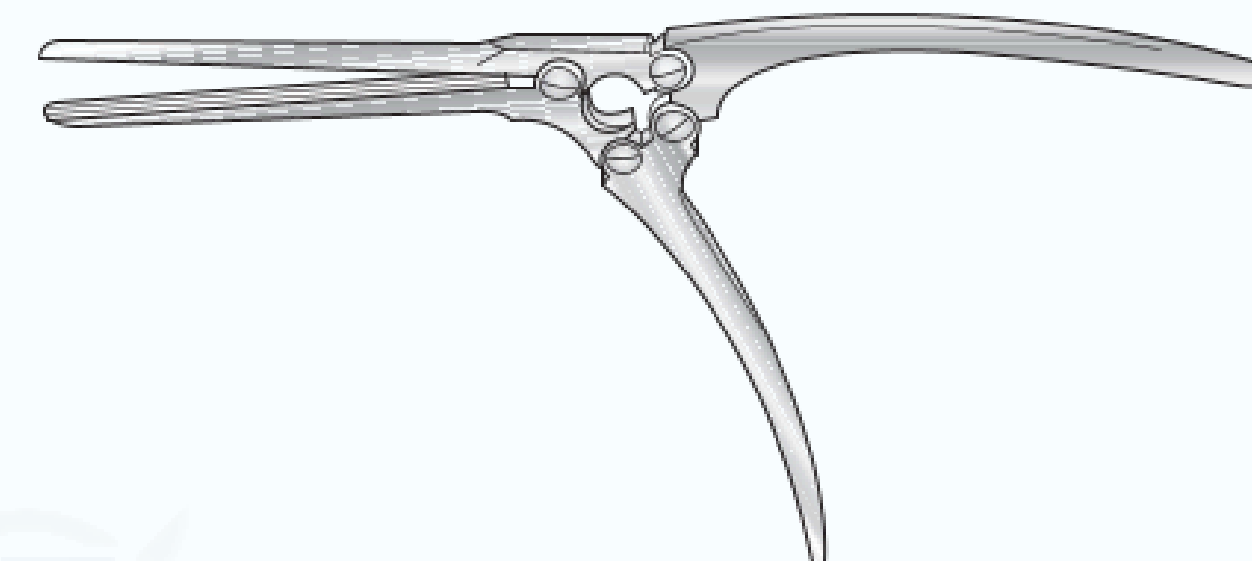

SC-IN/003	Extra small, 50mm blades, 150mm long
SC-IN/002a	Small, 65mm blades, 210mm long
SC-IN/002b	Medium, 100mm blades, 240mm long
SC-IN/002c	Large, 150mm blades graduated in inches, 360mm long

Yankauer Suction Tube

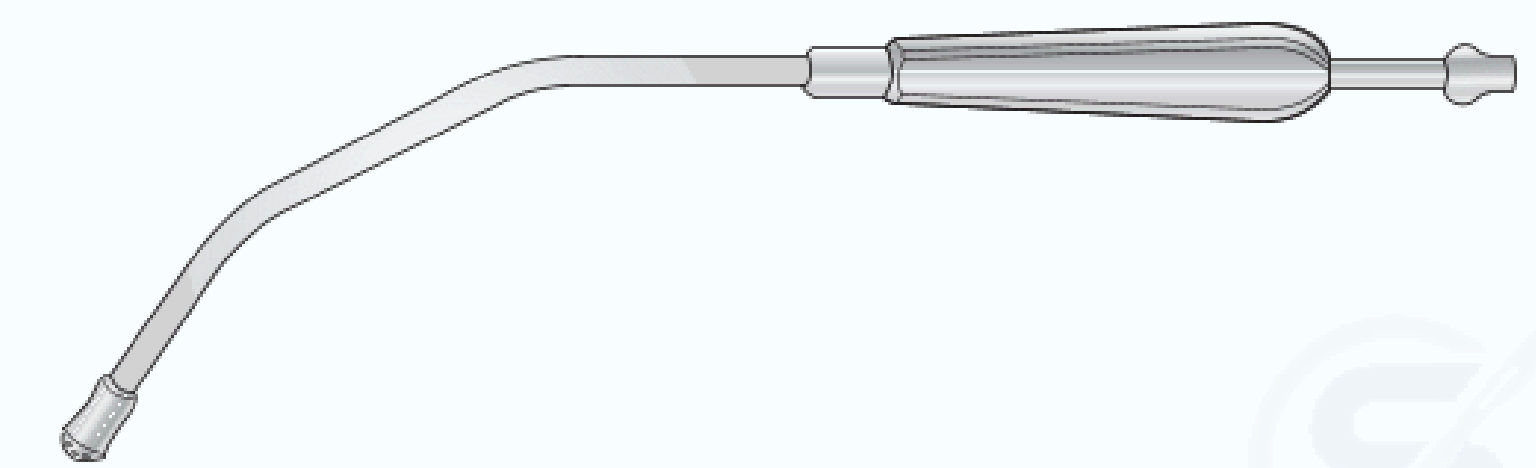

SC-IN/019	305mm long
-----------	------------