

GYNAECOLOGY INSTRUMENTS

A complete selection of instruments for diagnostic and surgical procedures in women's health. This category includes vaginal specula, tenacula, uterine curettes, biopsy forceps, ovum forceps, scissors, and retractors. Designed for atraumatic tissue handling, optimal access, and precise control during colposcopy, biopsy, dilatation and curettage, and major pelvic surgery. Crafted from premium stainless steel with ergonomic grips for reliable, comfortable use.



Parametrium Clamp Forceps

Hysterectomy clamp, atraumatic jaws, two gold bows

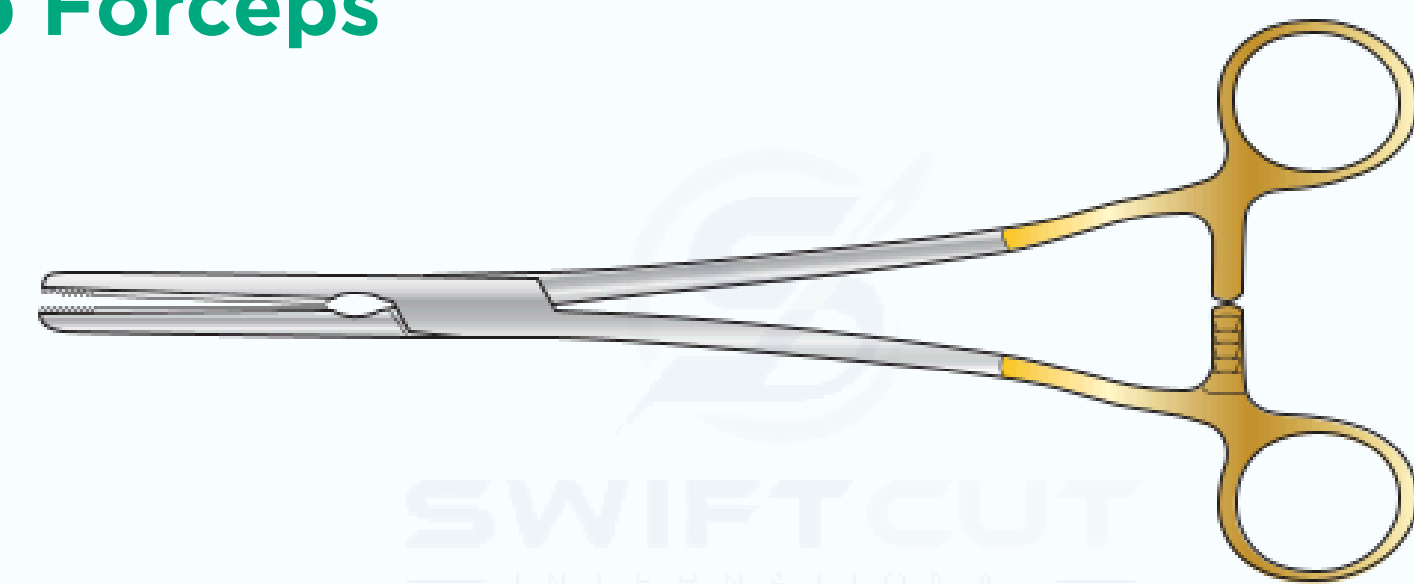

Straight

SC-GY/078	203mm long
SC-GY/078a	233mm long
SC-GY/078b	254mm long
SC-GY/078c	304mm long
SC-GY/078d	360mm long

Slight curve

SC-GY/078e	203mm long
SC-GY/078f	233mm long
SC-GY/078g	254mm long
SC-GY/078h	304mm long
SC-GY/078i	360mm long

Strong curve

SC-GY/078j	203mm long
SC-GY/078k	233mm long
SC-GY/078L	254mm long
SC-GY/078n	360mm long

Angled

SC-GY/078o	203mm long
SC-GY/078p	233mm long
SC-GY/078q	254mm long
SC-GY/078r	304mm long
SC-GY/078s	360mm long

Spencer-Robarts Clamp

For endometrial and pedunculated fibroid polyps, with ratchet jaw-locking mechanism, and 50° jaw opening

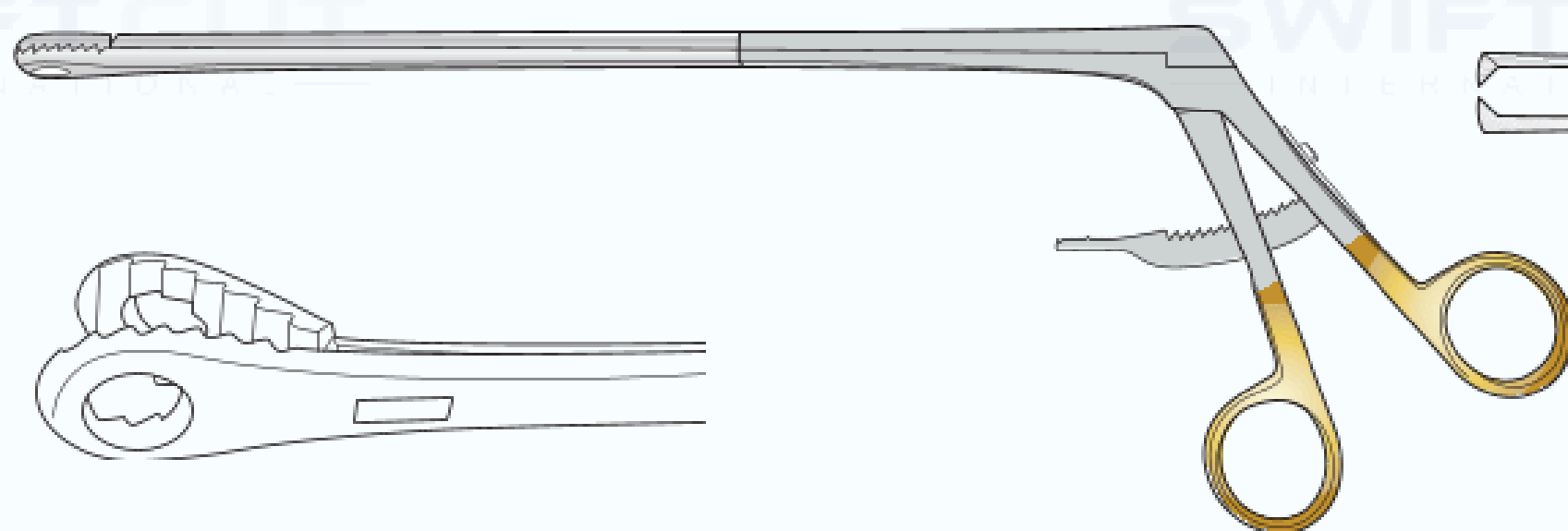

SC-GY/082	Shaft 235mm long
-----------	------------------

Museux Vulsellum Forceps

Matt finish

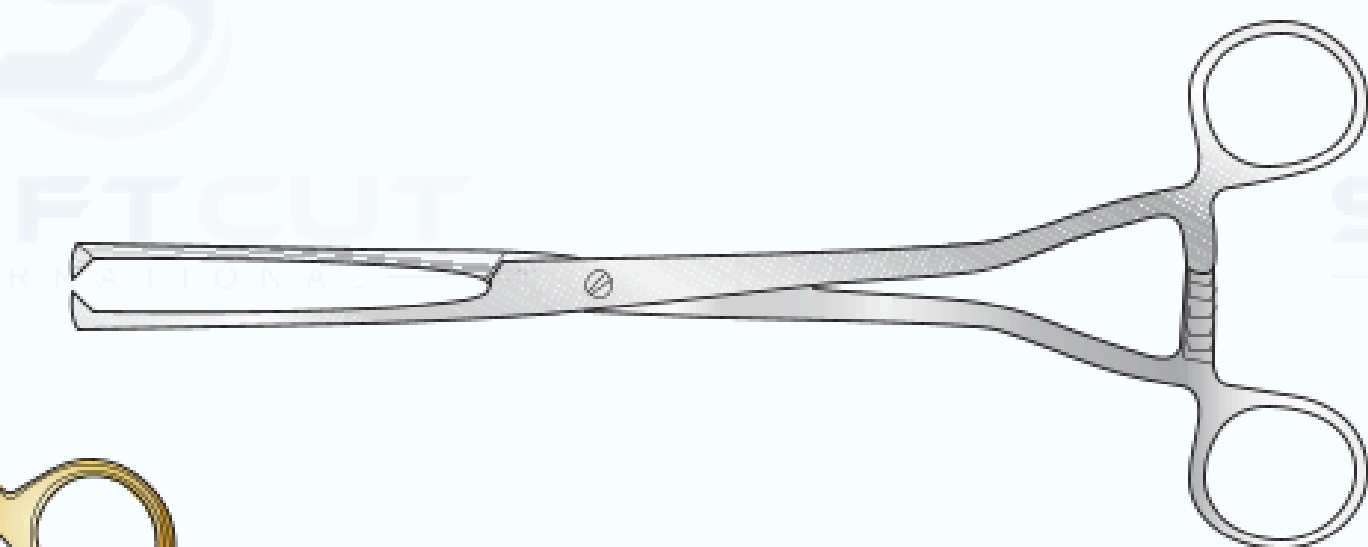

SC-GY/123	240mm long
-----------	------------

Schroeder Uterine Vulsellum Forcep

1-1 teeth

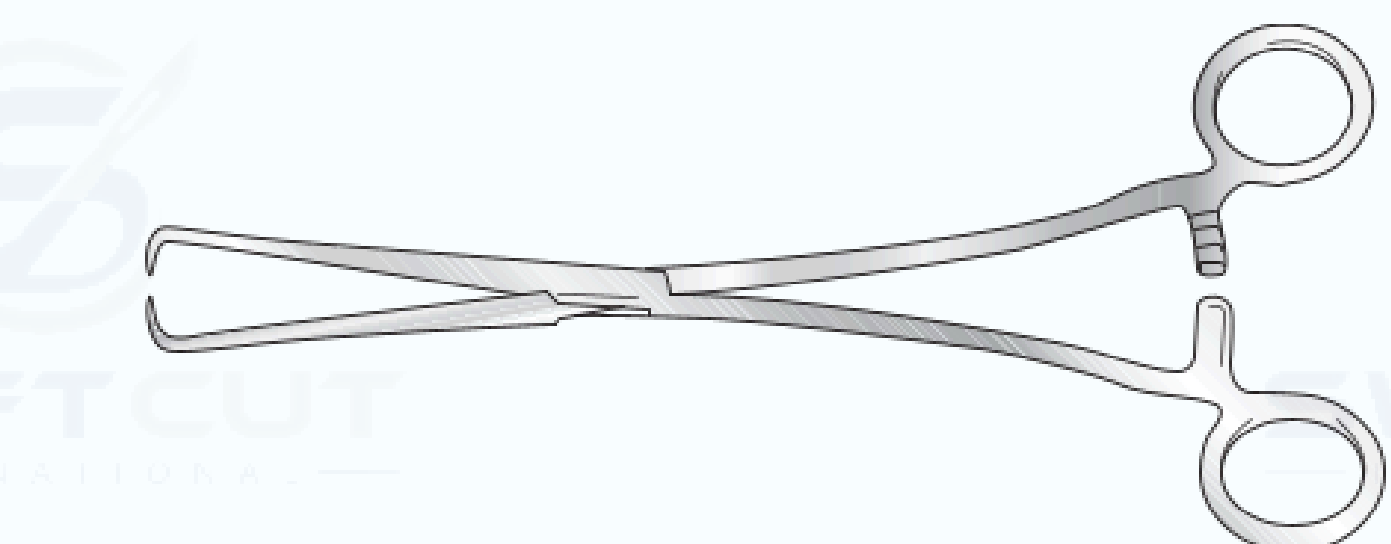

SC-GY/022	229mm long
-----------	------------

Teale Uterine Vulsellum Forcep

3-4 teeth, 230mm long

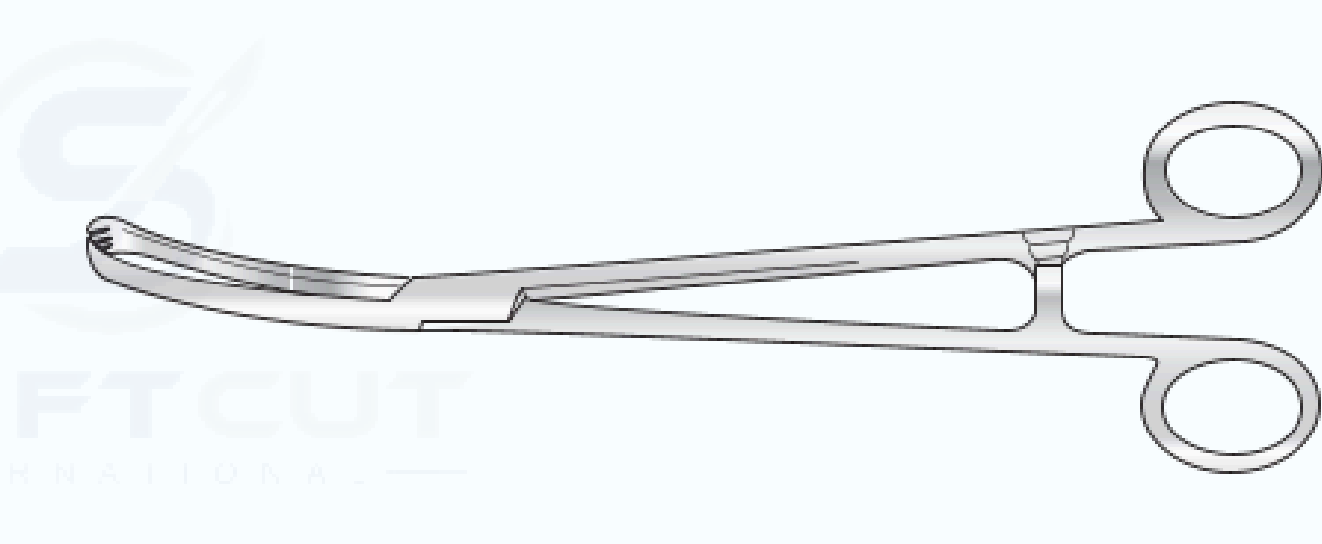

SC-GY/023	Curved
SC-GY/023a	Straight

Bonney Hysterectomy Forceps

Angled on flat, 1 - 2teeth

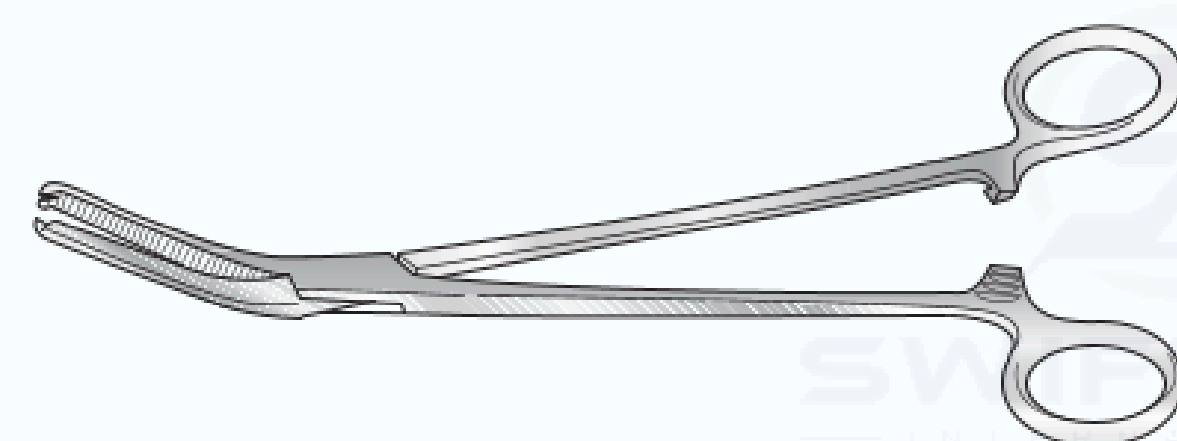

SC-GY/018	197mm long
-----------	------------

Berkeley-Bonney Hysterectomy Forceps

Curve don flat, 1 - 2teeth

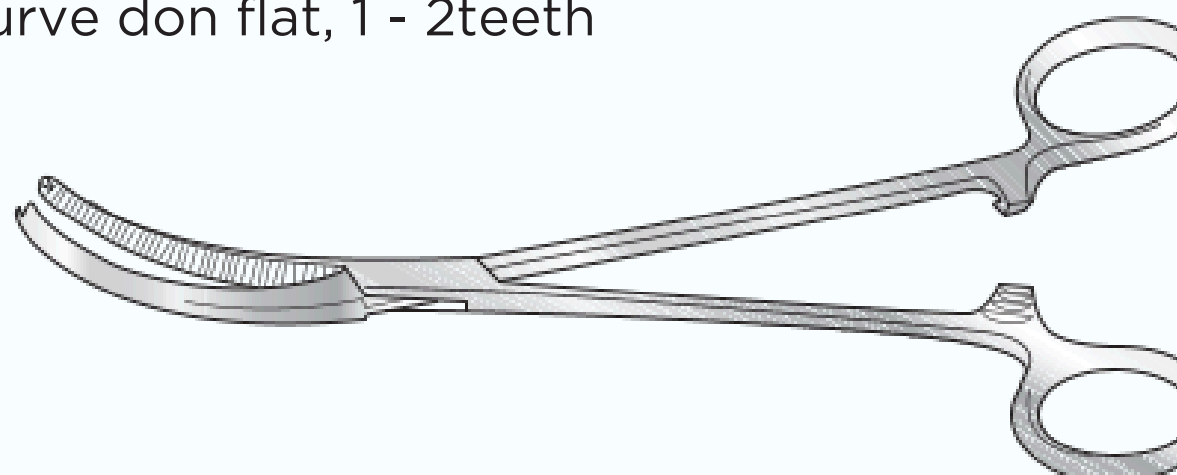

SC-GY/019	203mm long
-----------	------------

Gwilliam Hysterectomy Forceps

Longitudinal serrations
203mm long

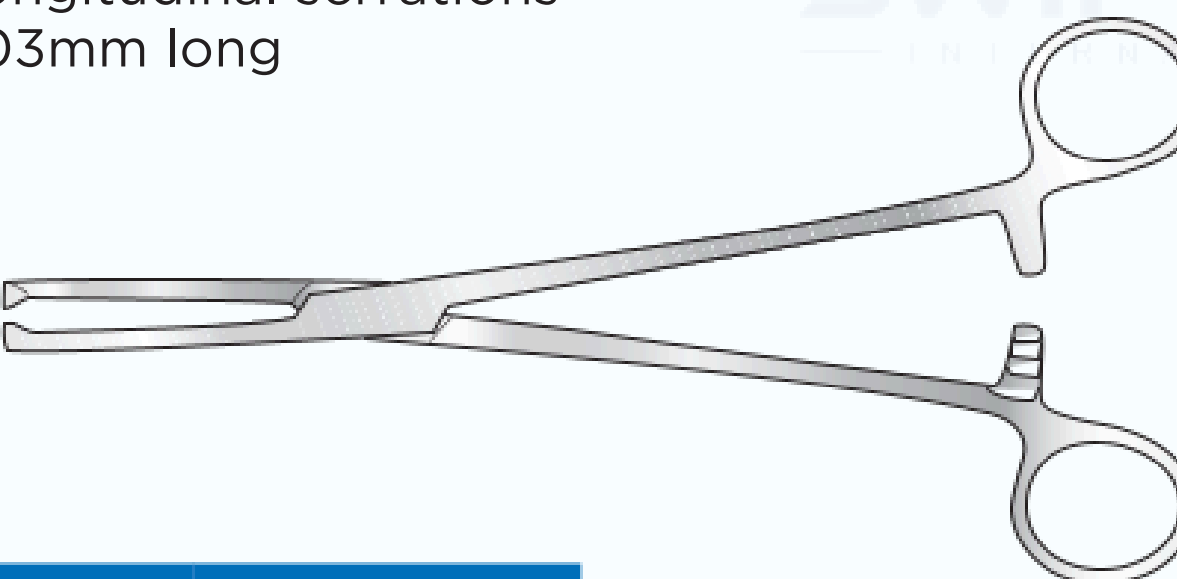

SC-GY/003a	Straight,
SC-GY/003b	Curved on flat, 1-2 teeth

Heaney Hysterectomy Forceps

Curve don flat, 203mm long

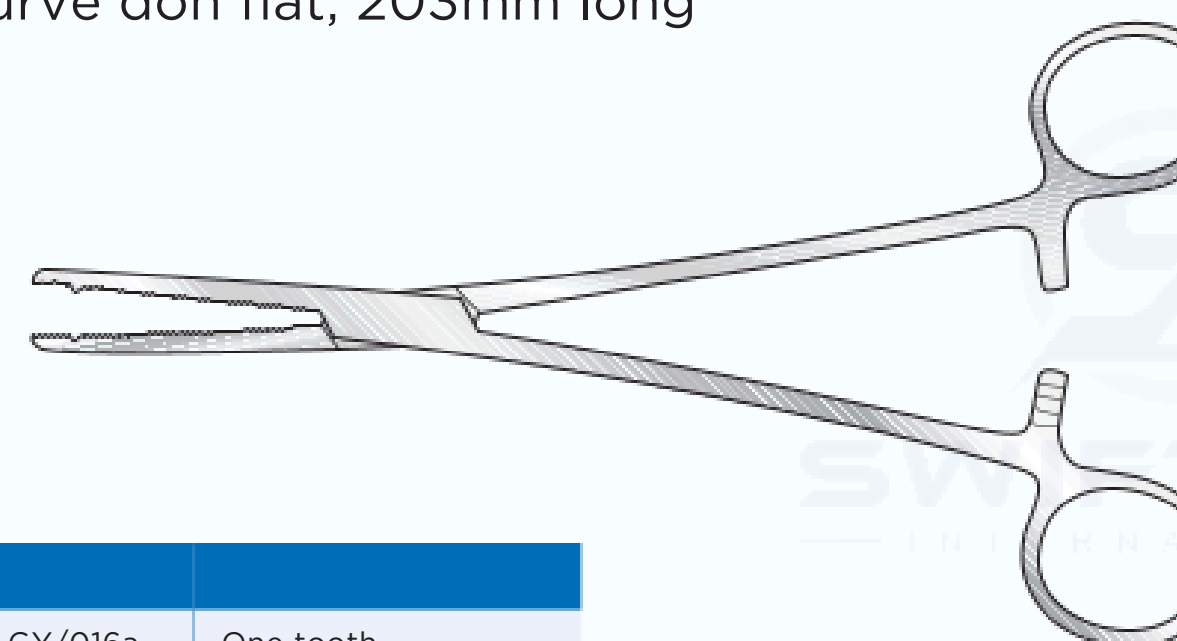

SC-GY/016a	One tooth
SC-GY/016b	Double tooth

Maingot Hysterectomy Forceps

203mm long

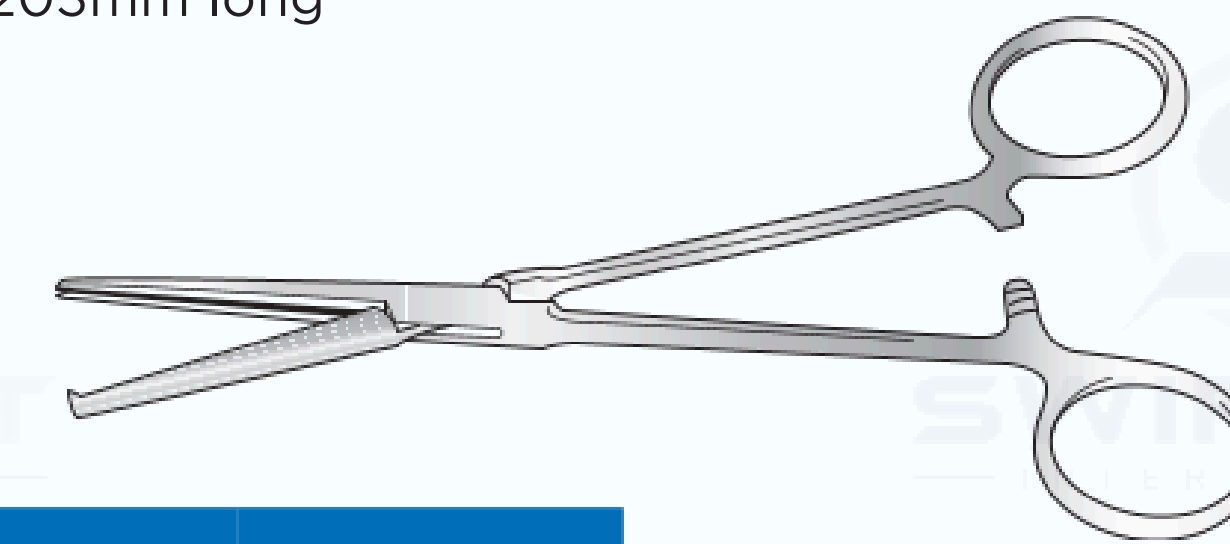

SC-GY/017a	Curved on flat, 1 - 2 teeth
SC-GY/017b	Straight

Faures Peritoneum Forceps

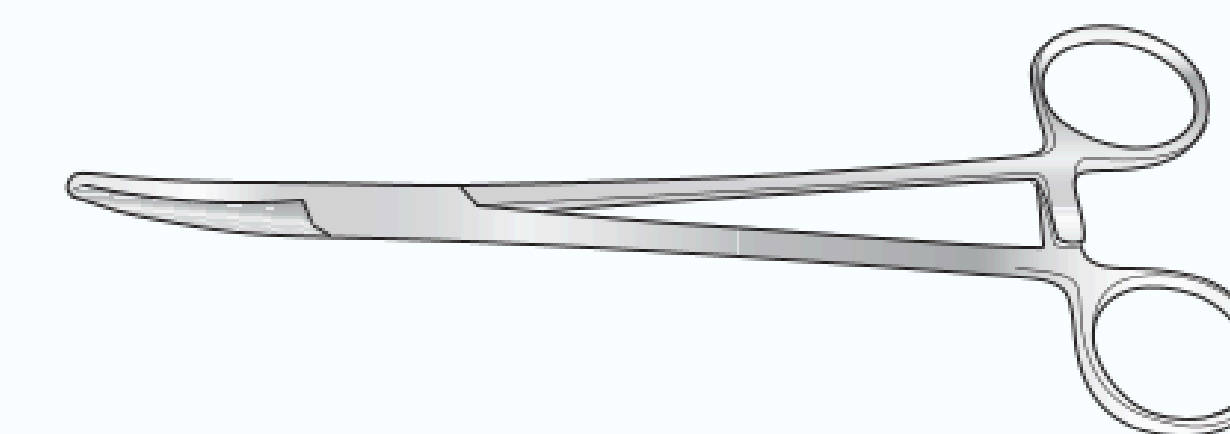

205mm long

SC-GY/146	Slight curve
-----------	--------------

203mm long, longitudinal serrations

SC-GY/5146	Curved, toothed
SC-GY/5146a	Curved

Bonney Uterine Polypus Forcep

Box joint

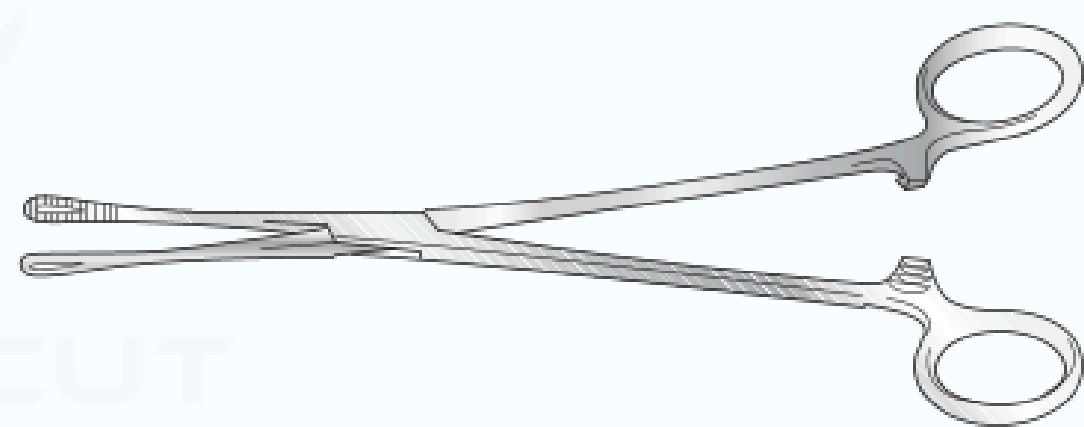

SC-020	1649mm
--------	--------

Somer Uturus Holding Forcep

Matt finish

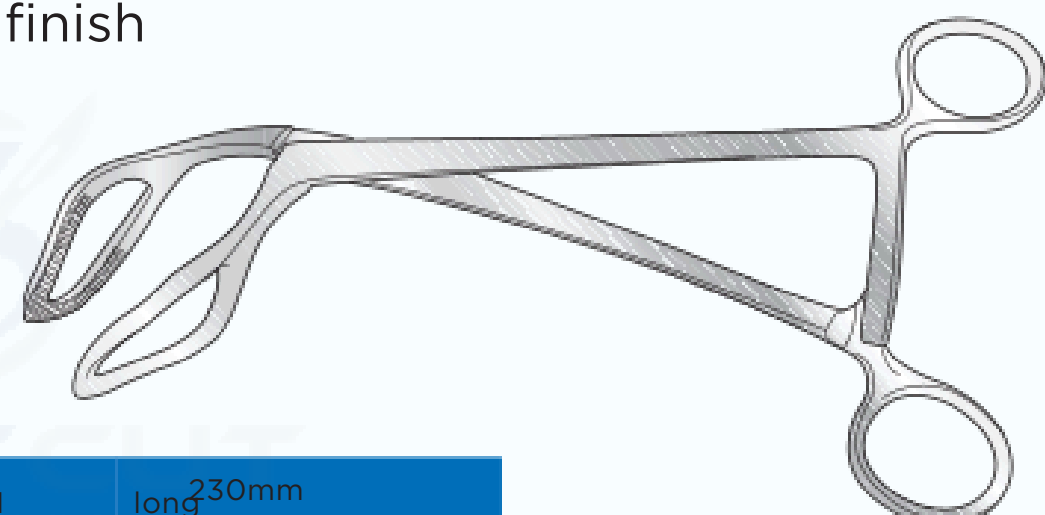

SC-091	long 230mm
SC-002	254mm long

Doyen Ovarian Forceps

Matt finish

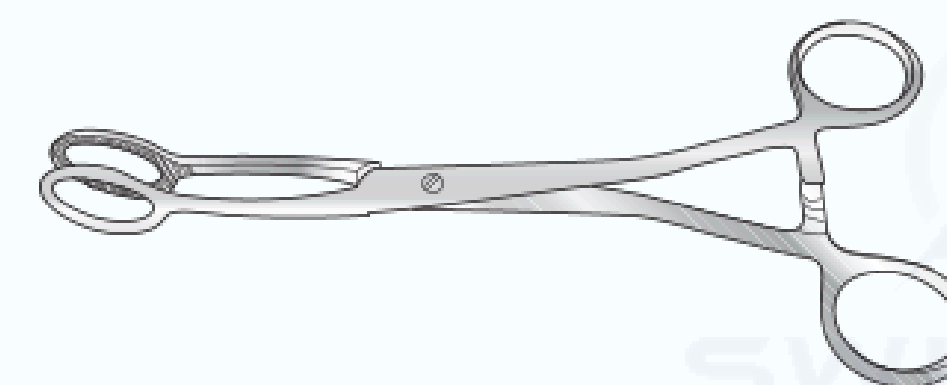

SC-GY/118	210mm long
-----------	------------

Lowa Tenaculum Forceps

Matt finish, 5-6 teeth

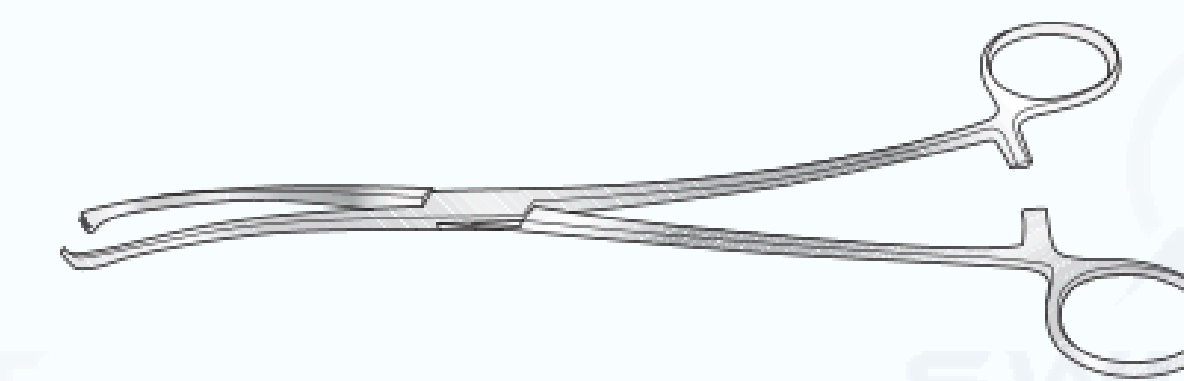

SC-GY/094	260mm long
-----------	------------



Noto Uterine Polypus Forceps

Matt finish

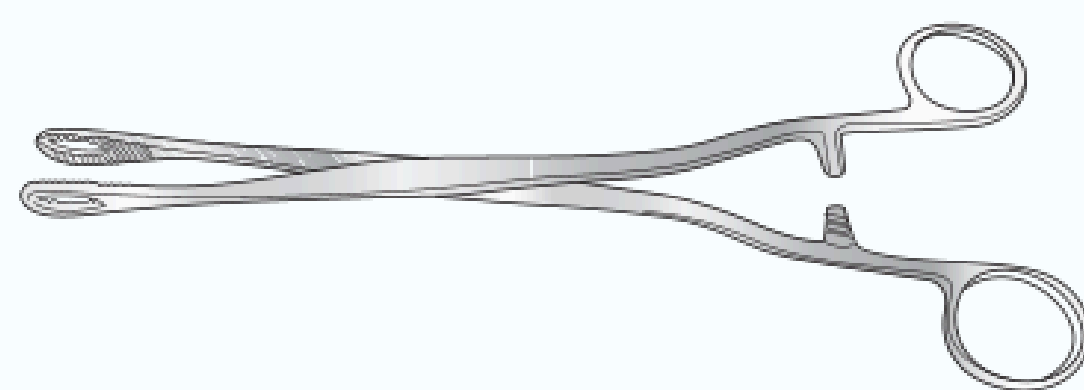

SC-724	1649mm
--------	--------

McClintock Ovum Forcep

Curved, screwjoint

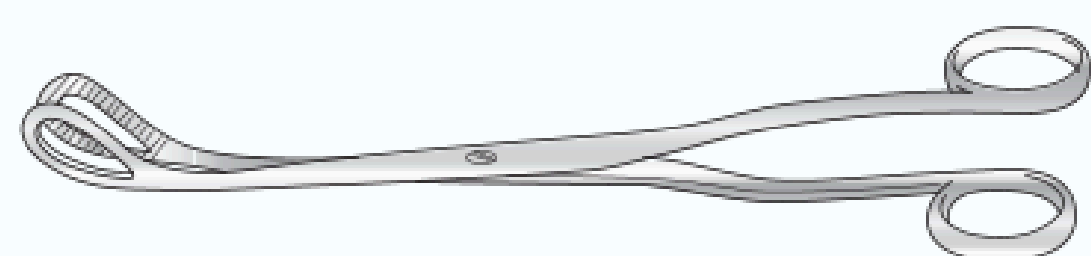

SC-736	long 241mm
--------	------------

Wertheim Parametrium Forcep

Curved onflat, screwjoint

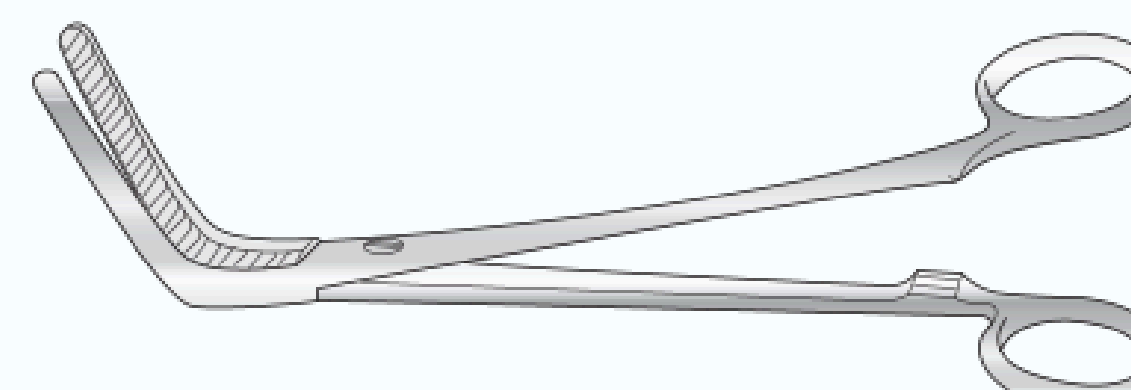

SC-GY/005	254mm long
-----------	------------

Skene Tenaculum Forceps

Bright finish

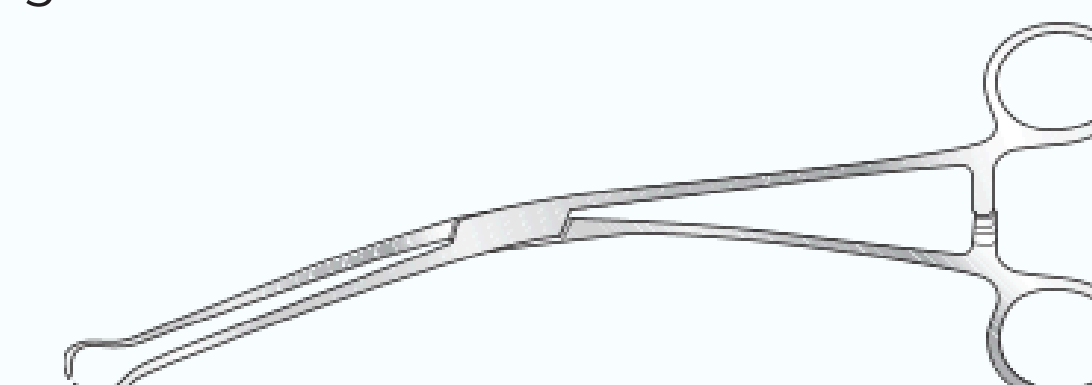

SC-GY/120	240mm long
-----------	------------

Vant Uterine Polypus Forcep

Serrated

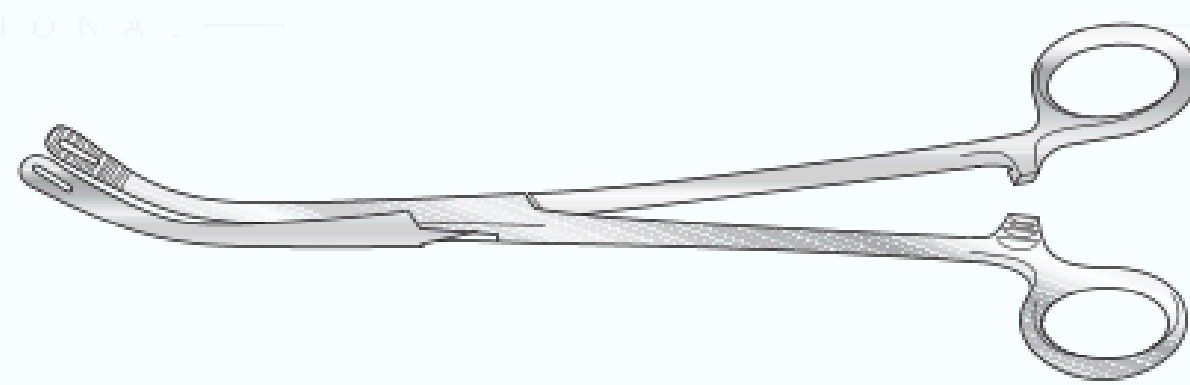

SC-7021	1649mm
---------	--------

Greenhalgh Ovum Forcep

Screwjoint

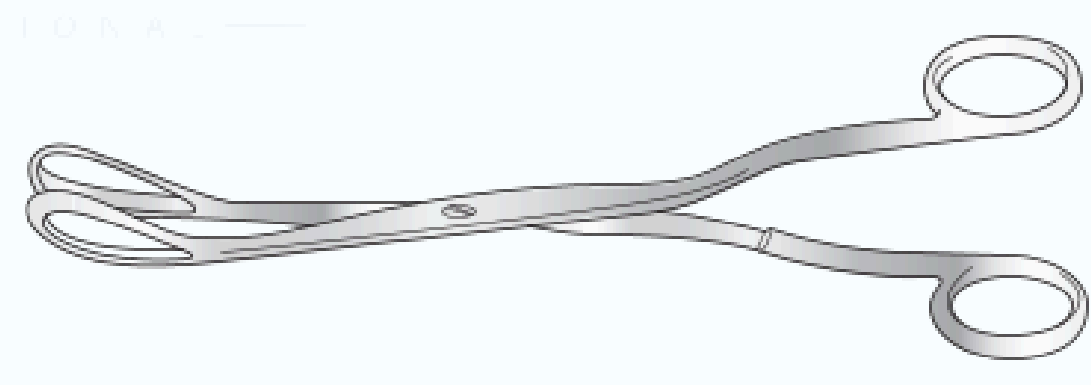

SC-7037	1649mm
---------	--------

Green-Armytage Haemostasis Forcep

Screw joint, 15mm jaw, 210mm long

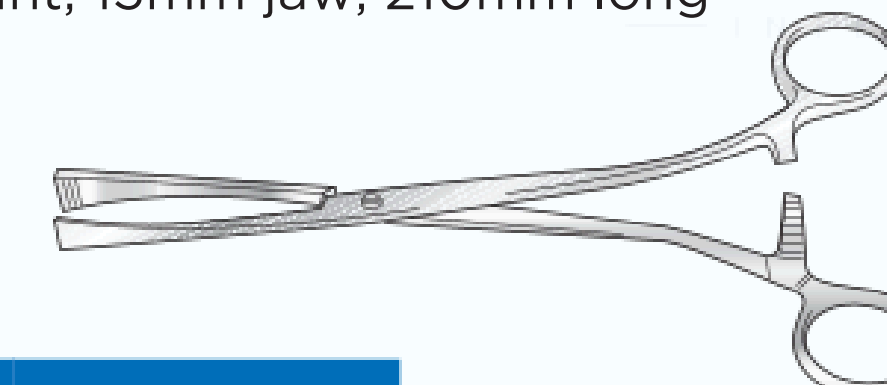

SC-GY/029a	Straight
SC-GY/029b	Angled

Pratt Tenaculum Forceps

Matt finish

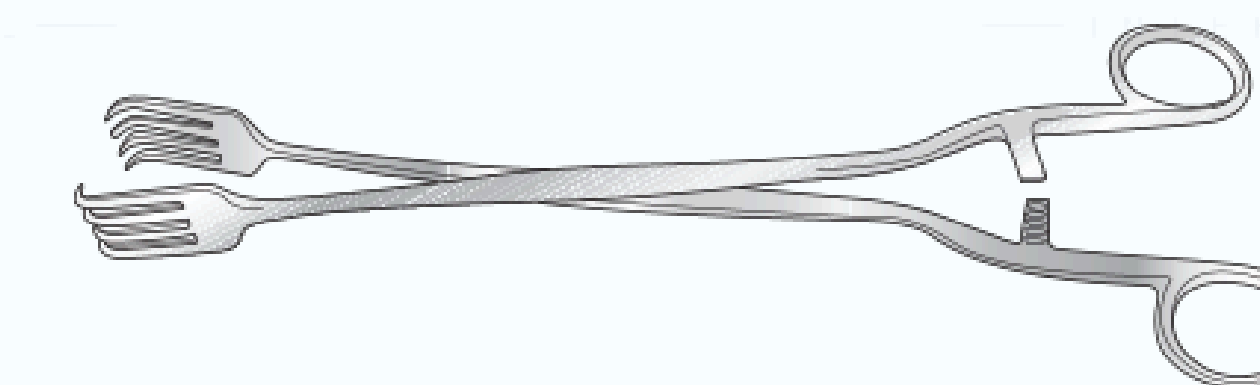

SC-GY/095	280mm long
-----------	------------

Dartigues Uterine Forceps

Mattfinish

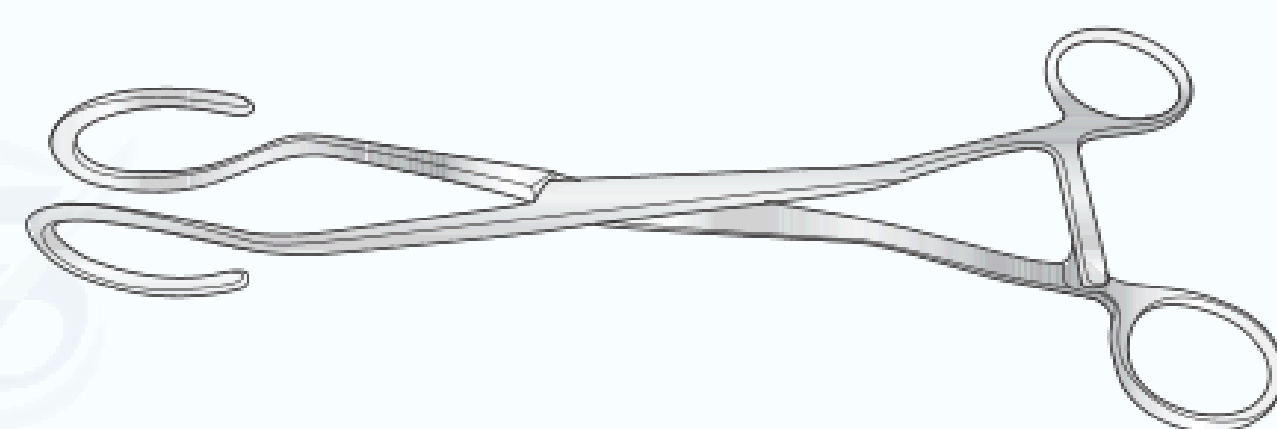

SC-090	1679mm
--------	--------

Keily Ovum Forceps

Matt finish

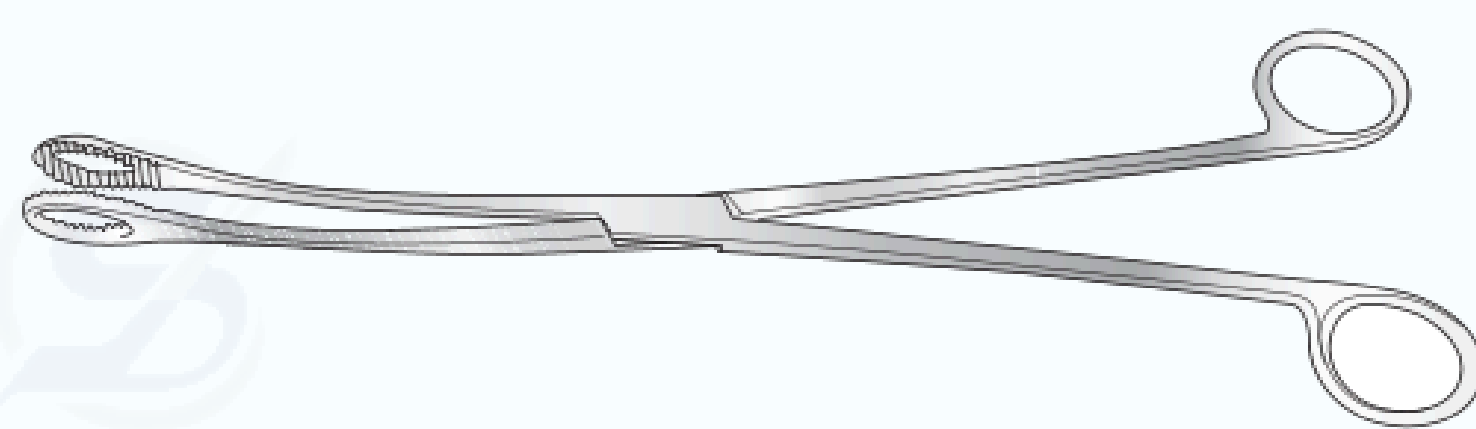

SC-711	1649mm
--------	--------

Kogan Endocervical Forceps

Matt finish, 275mm long

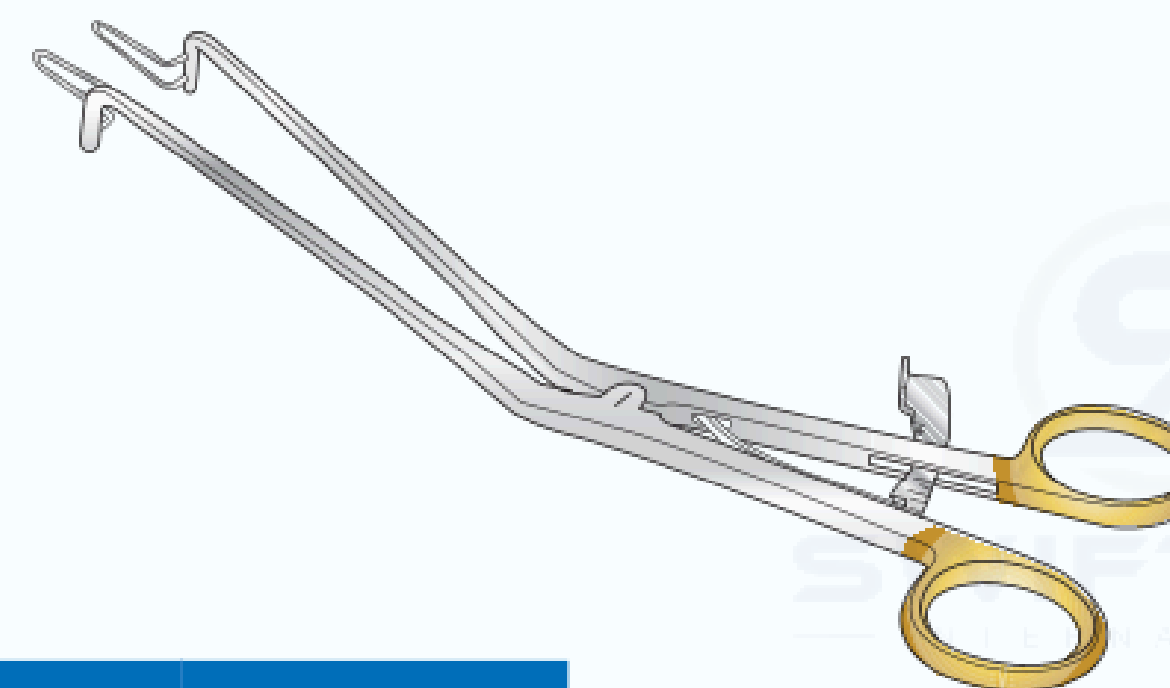

SC-GY/131	3mm jaw
SC-GY/131a	5mm jaw
SC-GY/131b	7mm jaw

Coil Removing Forcep

With serrated rounded jaws
4mm wide



SC-GY/075	160mm to shoulder
-----------	-------------------

Willet Martel Forceps

Matt finish

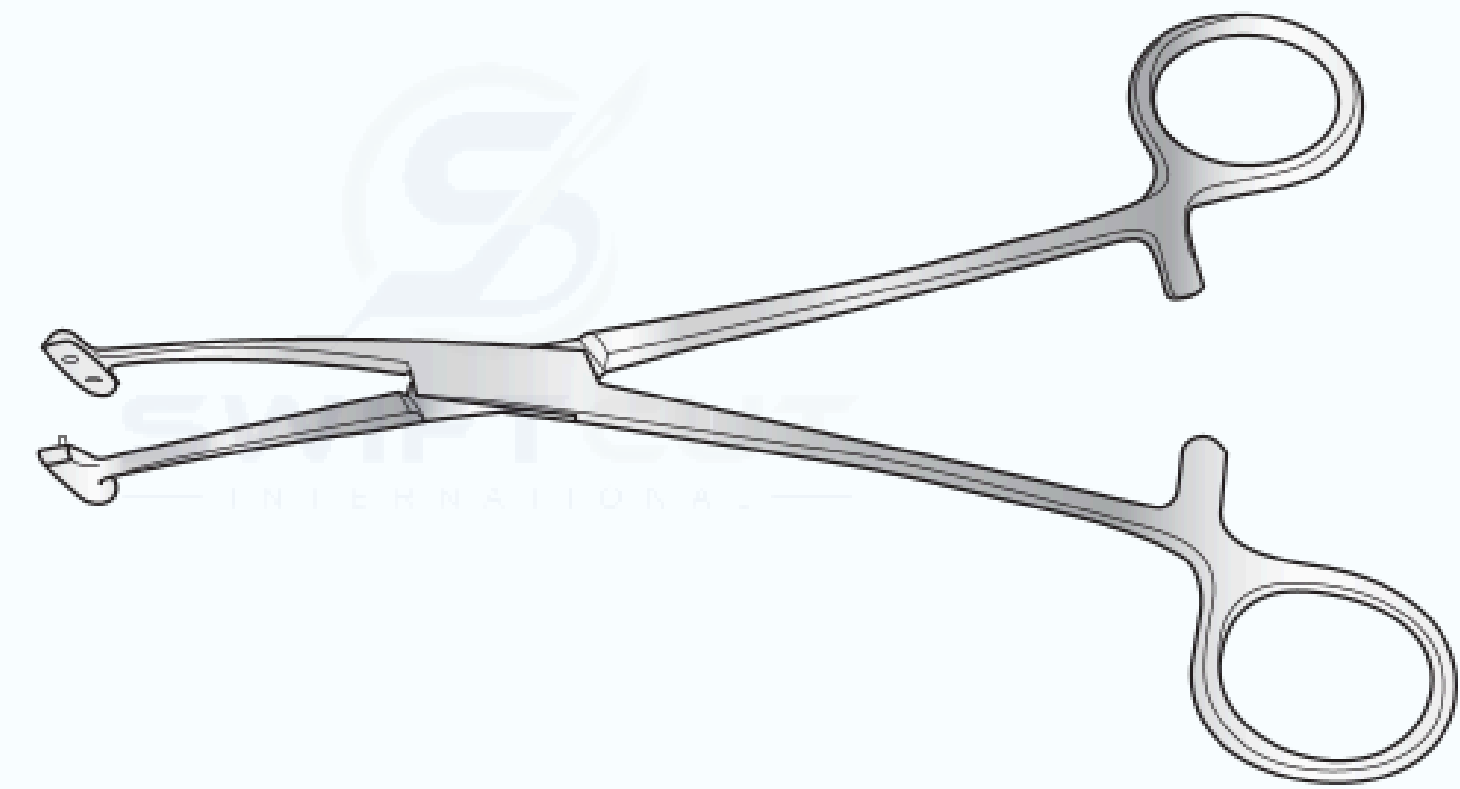

SC-GY/121	190mm long
-----------	------------

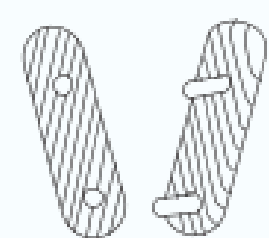

Littlewood Tissue Forceps

2-3 teeth, matt finish

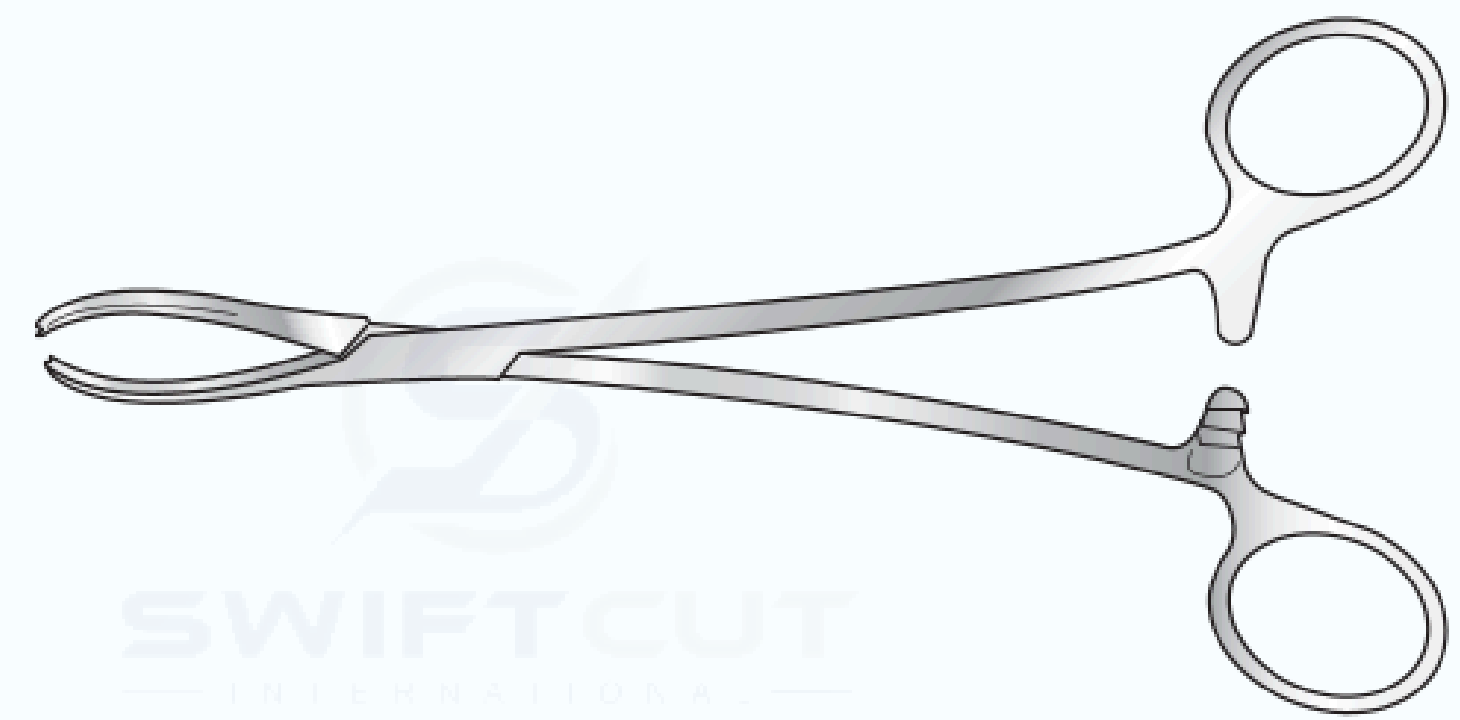

SC-GY/275	190mm long
-----------	------------

Eppendorf Biopsy Punch Forcep

200mm to shoulder

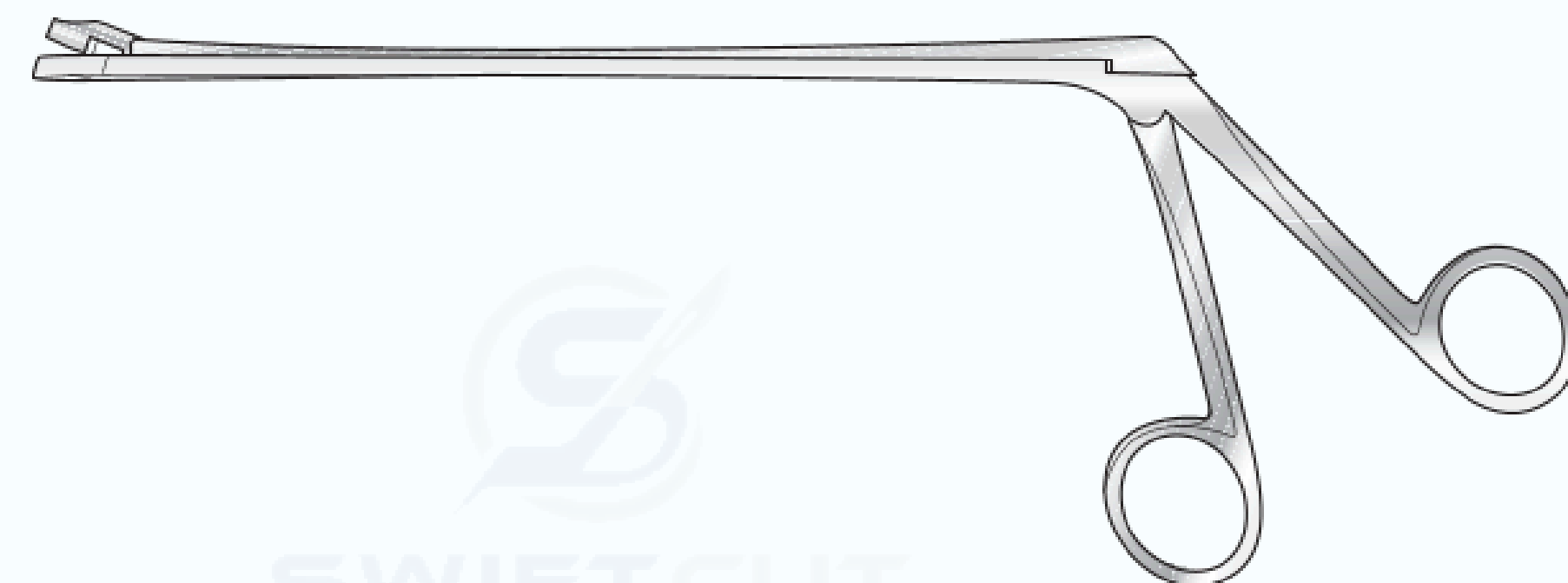

 Bite shown actual size

SC-GY/14-314-200	3mm x 8mm bite
------------------	----------------

Kevorkian Biopsy Punch Forcep

255mm to shoulder





 Bite shown actual size

SC-GY/14-329-250	3mm x 8mm bite
------------------	----------------

Tischler Morgan Biopsy Forcep

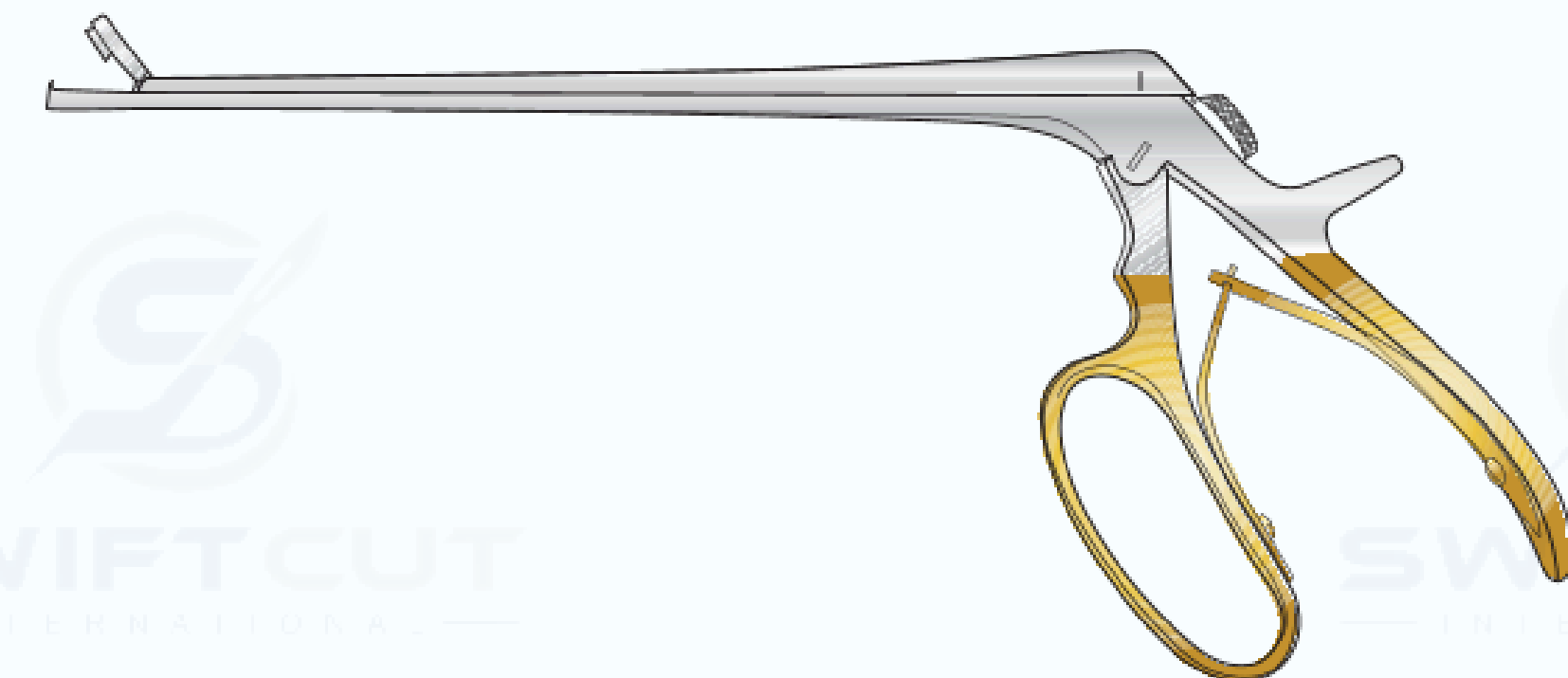
210mm to shoulder



 Bite shown actual size

SC-GY/14-328-220	3mm x 7mm bite
------------------	----------------

Tischler Morgan Biopsy Punch Forcep

295mm to shoulder





 Bite shown actual size

SC-GY/088	2mm x 7mm bite
-----------	----------------

Baby Tischler Biopsy Forcep

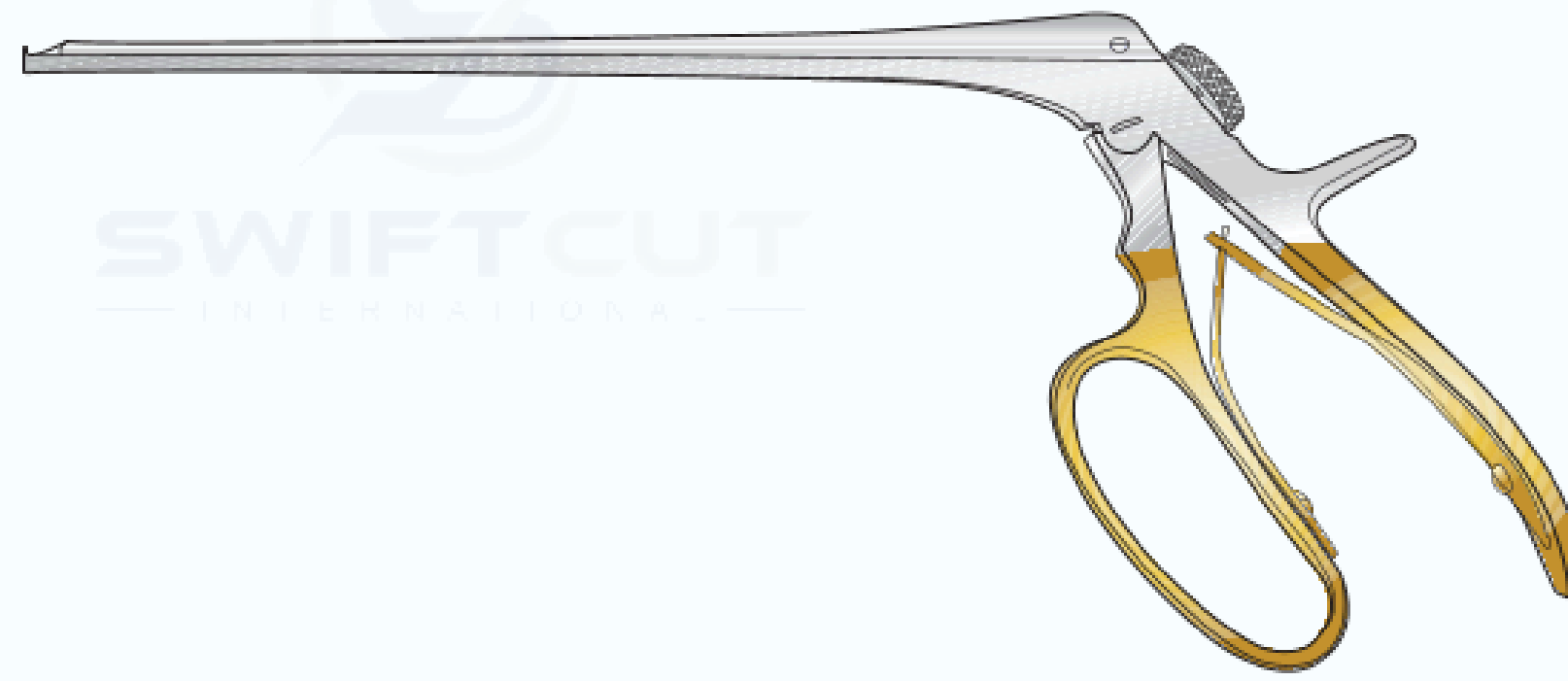
210mm to shoulder



 Bite shown actual size

SC-GY/14-325-250	2mm x 5mm bite
------------------	----------------

Baby Tischler Biopsy Punch Forcep

295mm to shoulder

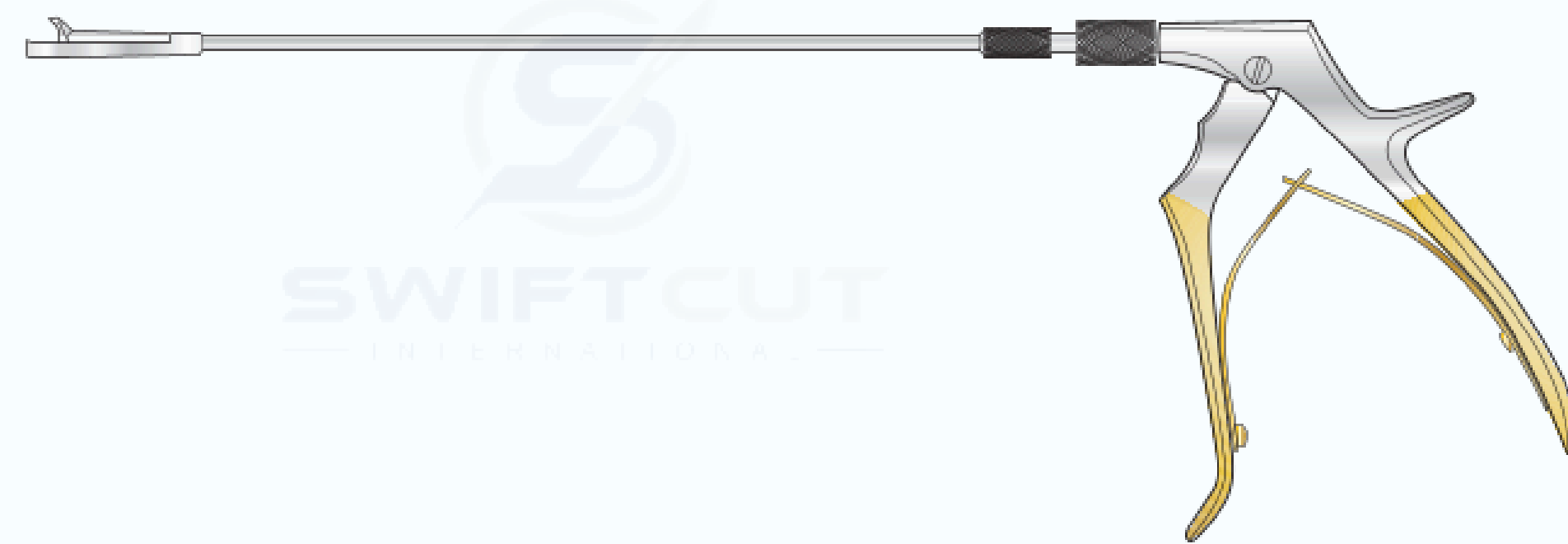

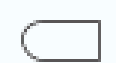

 Bite shown actual size

SC-GY/087	2mm x 5mm bite
-----------	----------------

Van Doren Biopsy Forceps

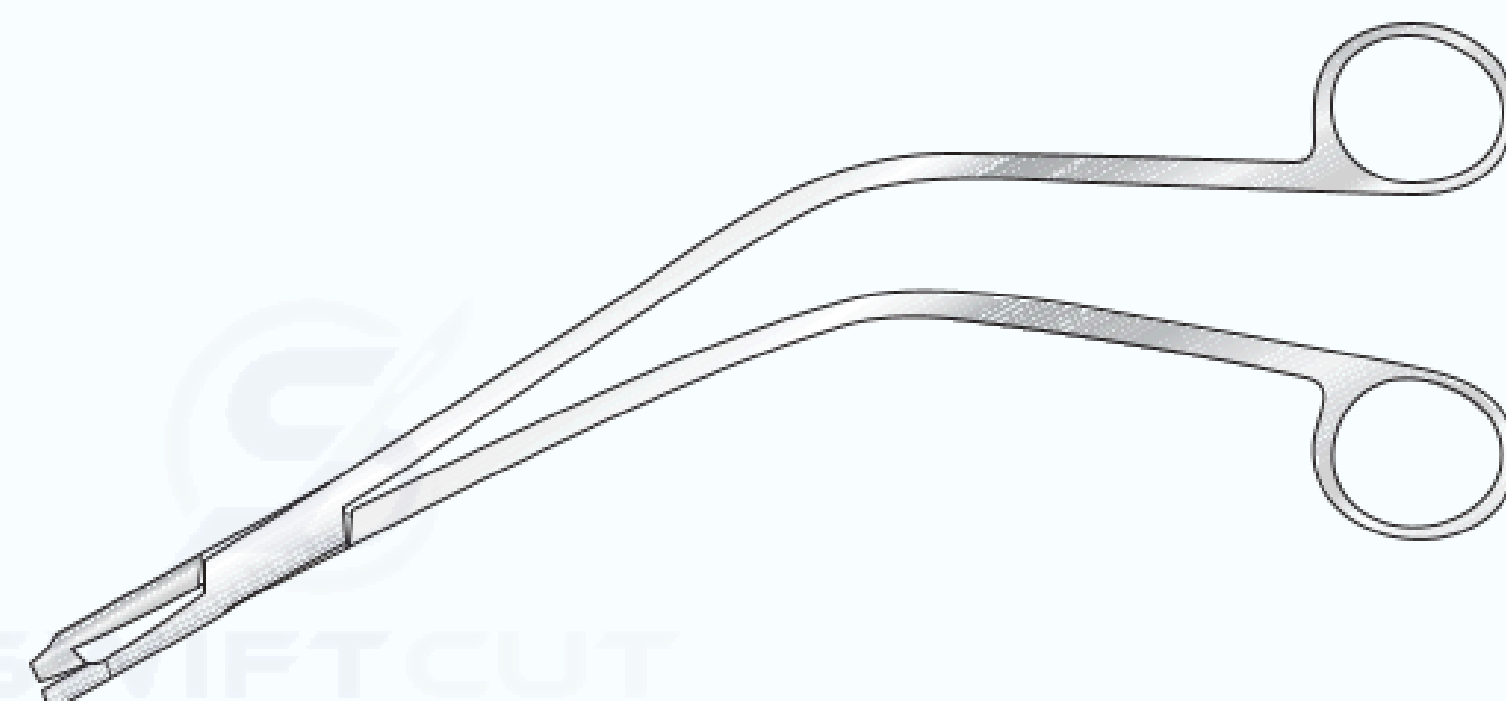
Bright finish, 260mm overall length



 Bite shown actual size

SC-GY/112	5mm x 9mm bite
-----------	----------------

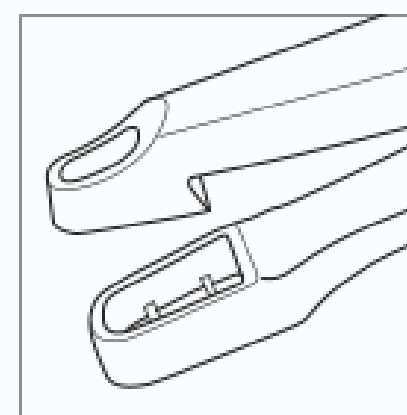

Van Doren Cervical Biopsy Punch Forcep

With curved basket jaw, angled shanks

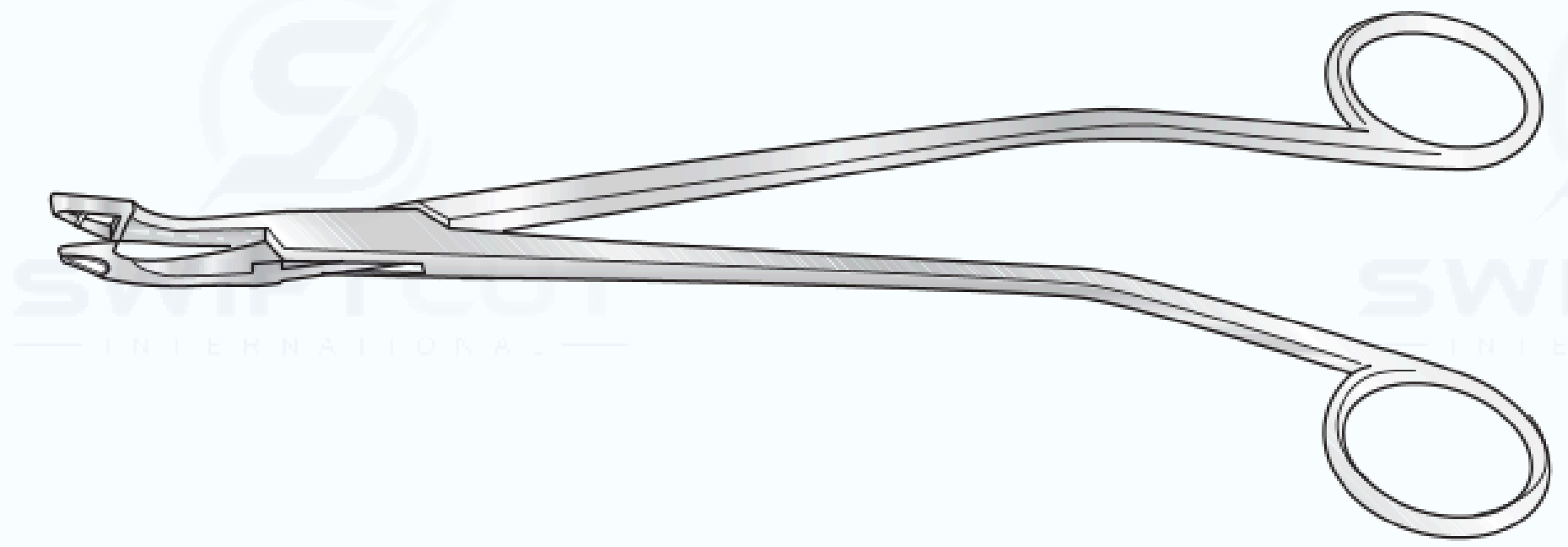

SC-GY/025	240mm long
-----------	------------

Wittner Cervical Biopsy Punch Forcep

240mm longshaft



SC-GY/024a	Jaws curved to side
SC-GY/024b	Jaws straight to side

Barnes Obstetric Forcep

With Simpson handles and Neville axis-traction rod

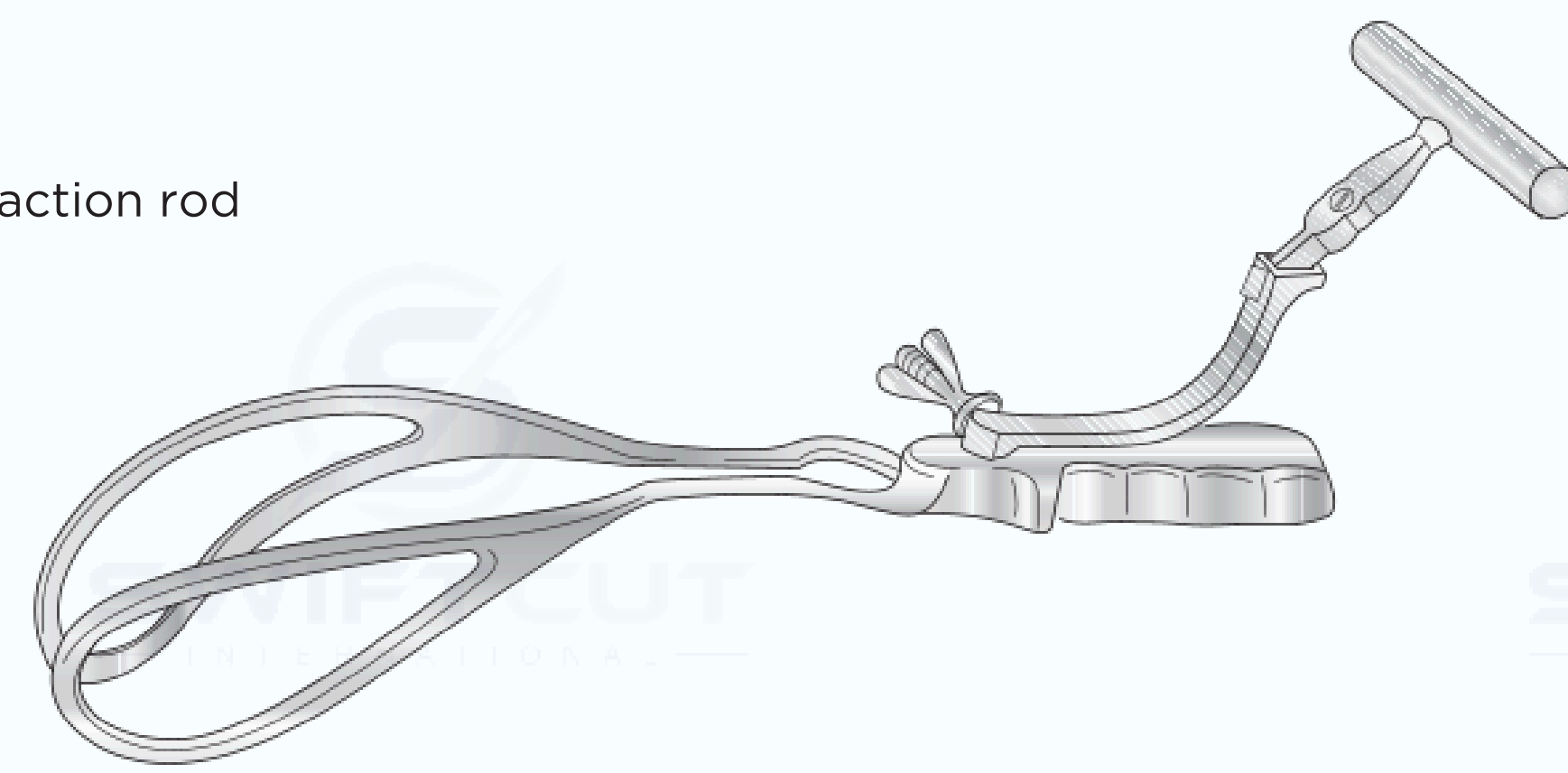

SC-GY/027	381mm long
-----------	------------

Haig Ferguson Obstetric Forcep

Tape slots in blades and axis traction rod

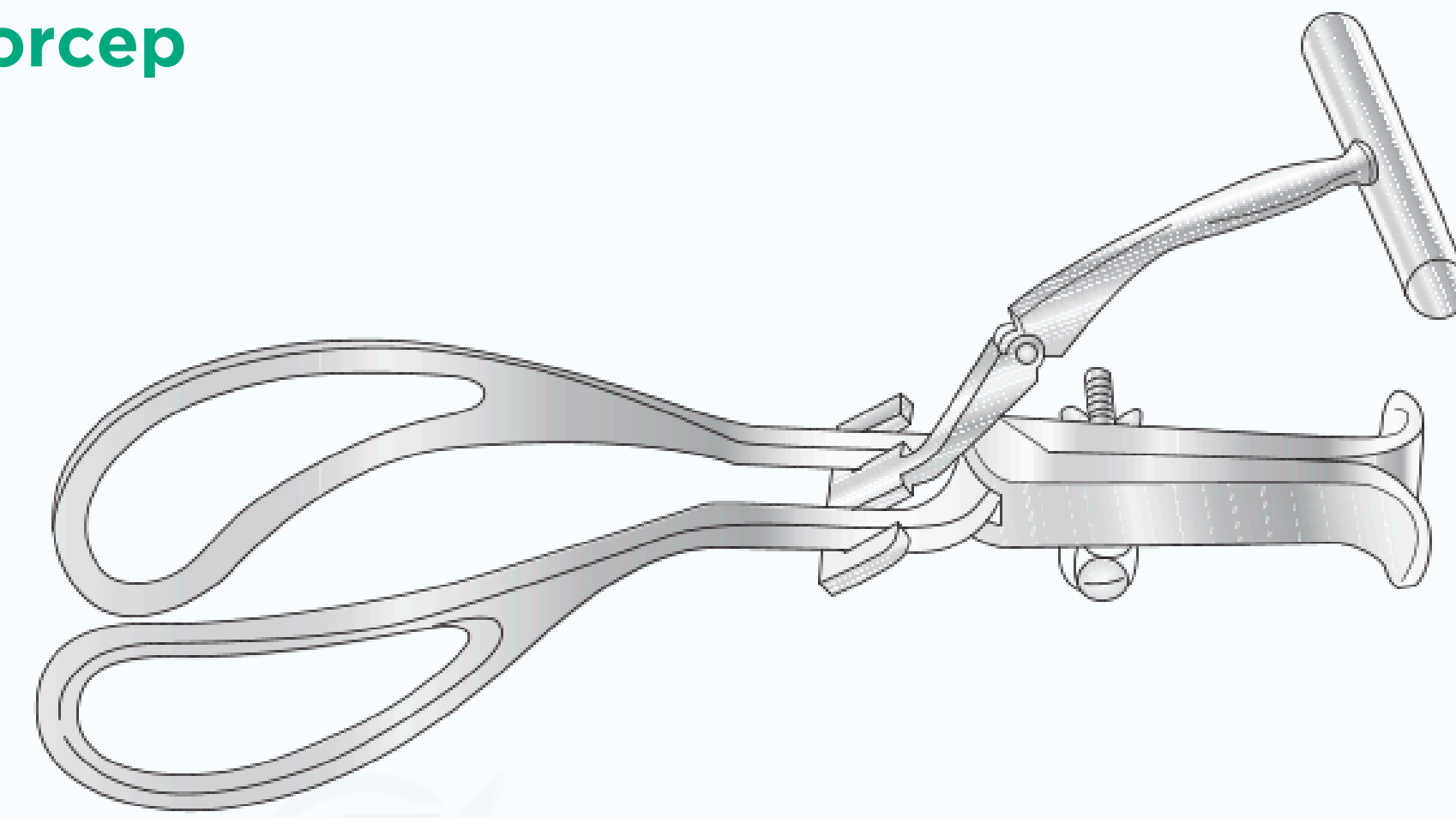

SC-GY/028	356mm long
-----------	------------

Kieland Obstetric Forcep

Matt finish

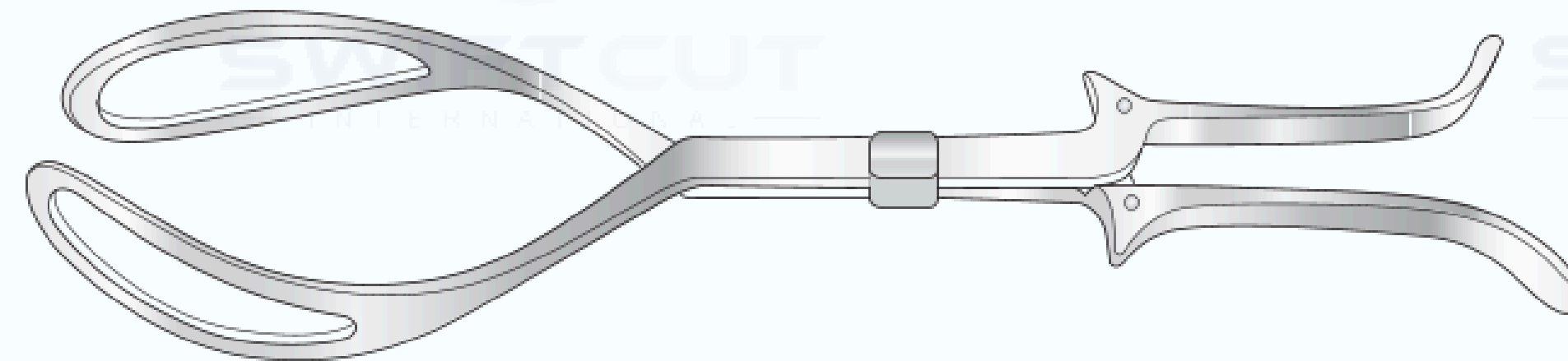

SC-GY/089	410mm long
-----------	------------

Simpson Braun Obstetric Forcep

Matt finish

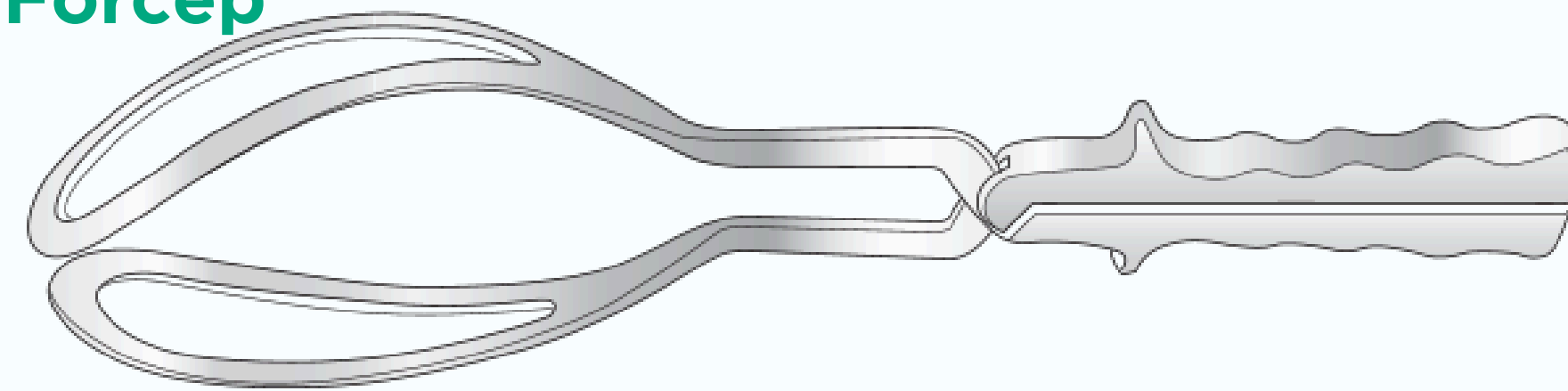

SC-GY/086	380mm long
-----------	------------

Wrigley Obstetric Forcep

Short model for caesarian section

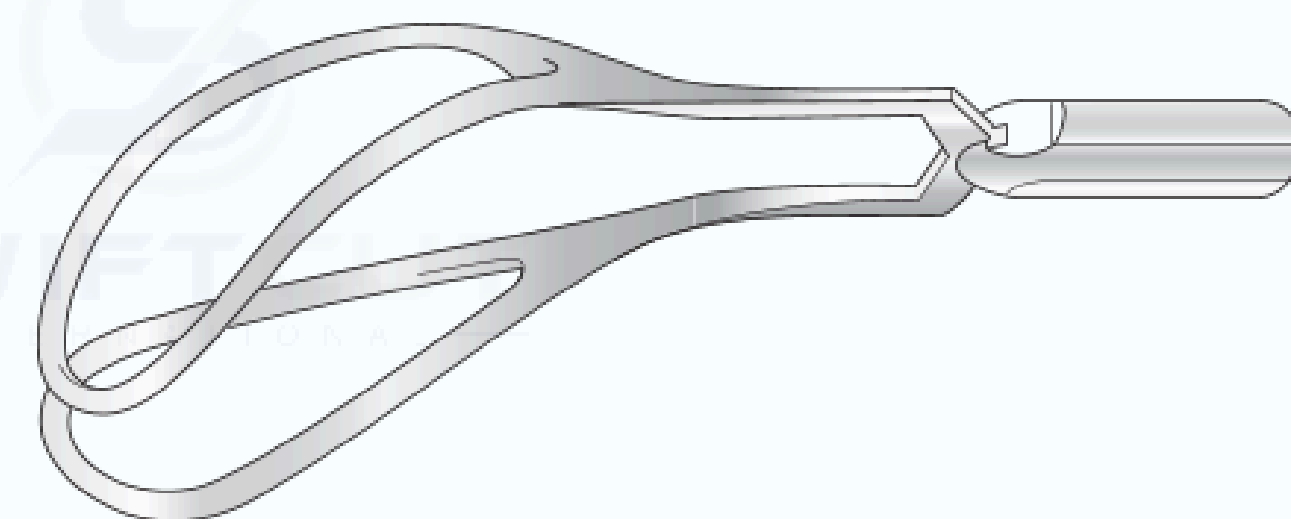

SC-GY/026	279mm long
-----------	------------

Auvarde Vaginal Speculum

Weighted

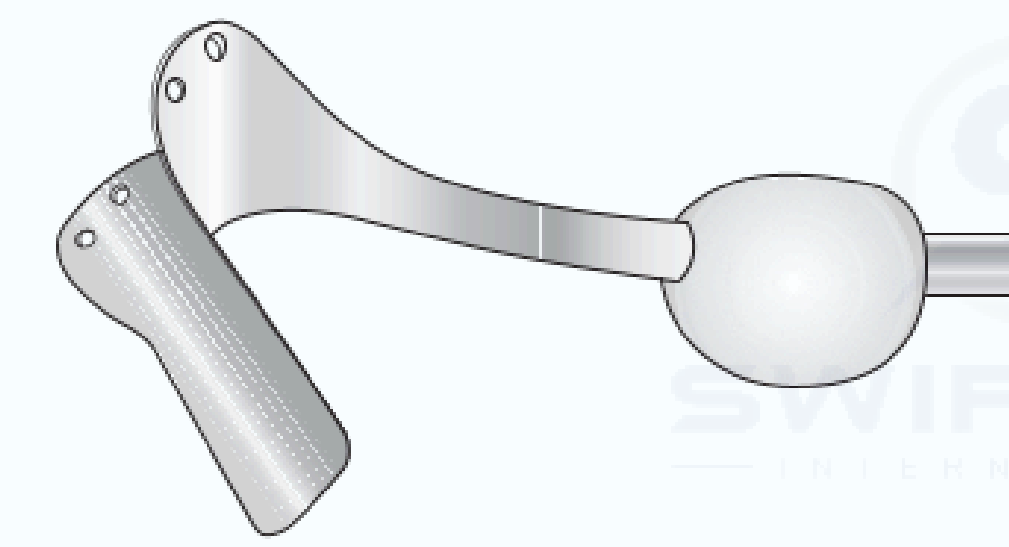

SC-GY/007a	Small blade 38 x 90mm
SC-GY/007b	Large blade 51 x 90mm

Graves Vaginal Speculum

Bright finish



SC-GY/103	115 x 35mm
-----------	------------

Cusco Vaginal Speculum

Stainless steel

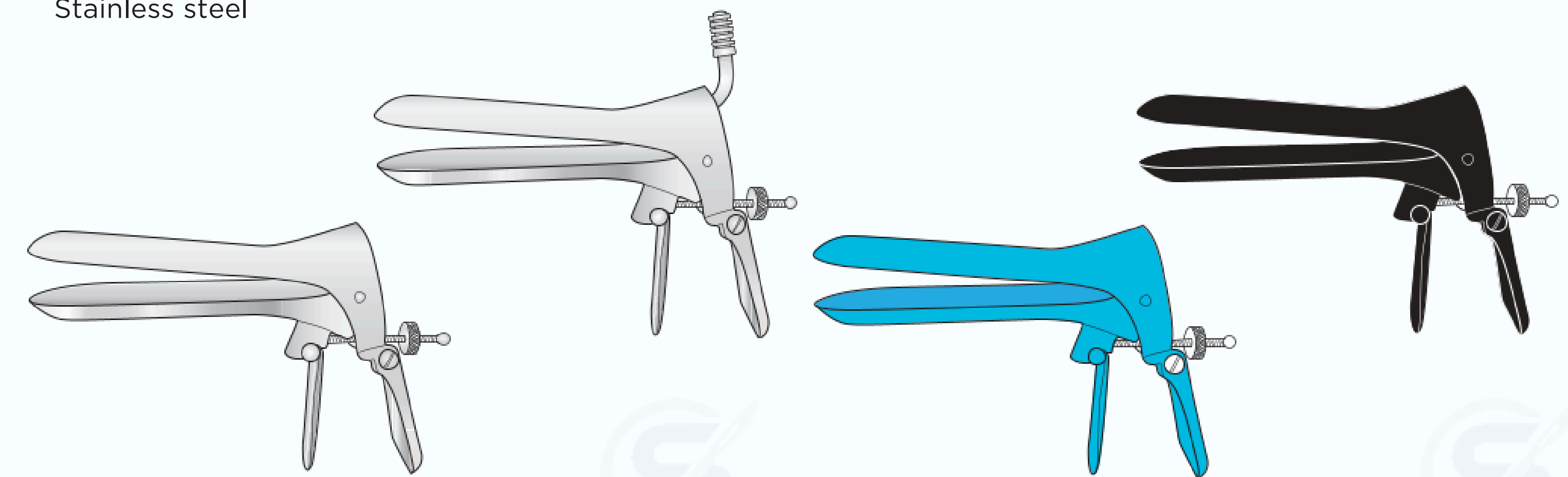

		Insulated		With Suction Tube		Black Finish	
SC-GY/015d	Extra small - 98mm x 16mm	SC-GY/134	Small - 105mm x 25mm	SC-GY/015k	Small - 105mm x 25mm	SC-GY/138	Small - 105mm x 25mm
SC-GY/015c	Small - 105mm x 25mm	SC-GY/135	Medium - 107mm x 29mm	SC-GY/015j	Medium - 107mm x 29mm	SC-GY/139	Medium - 107mm x 29mm
SC-GY/015f	Medium - 107mm x 29mm	SC-GY/136	Large - 115mm x 35mm	SC-GY/015i	Large - 115mm x 35mm	SC-GY/140	Large - 115mm x 35mm
SC-GY/015e	Large - 115mm x 35mm	SC-GY/137	Extra large - 135mm x 38mm	SC-GY/015h	Extra large - 135mm x 38mm	SC-GY/141	Extra large - 135mm x 38mm

Collin Vaginal Speculum

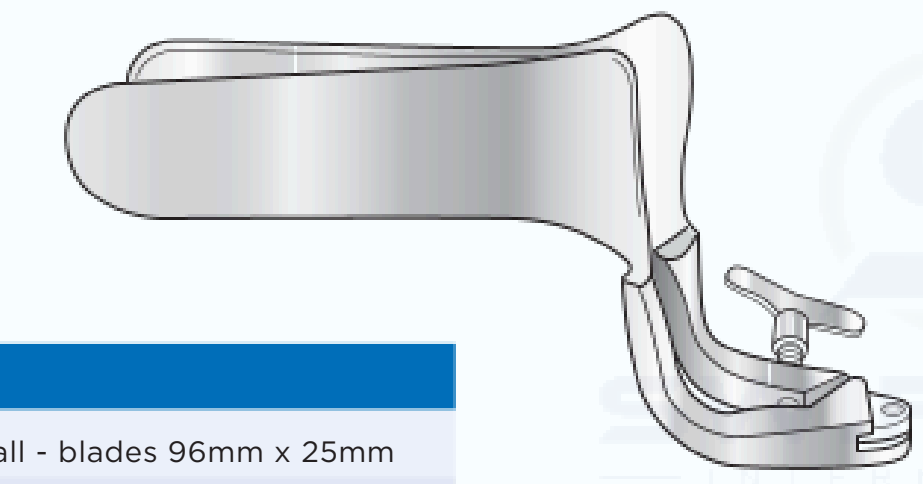

SC-GY/014a	Small - blades 96mm x 25mm
SC-GY/014b	Medium - blades 108mm x 30mm
SC-GY/014c	Large - blades 108mm x 35mm

Nott Speculum

Stainless steel

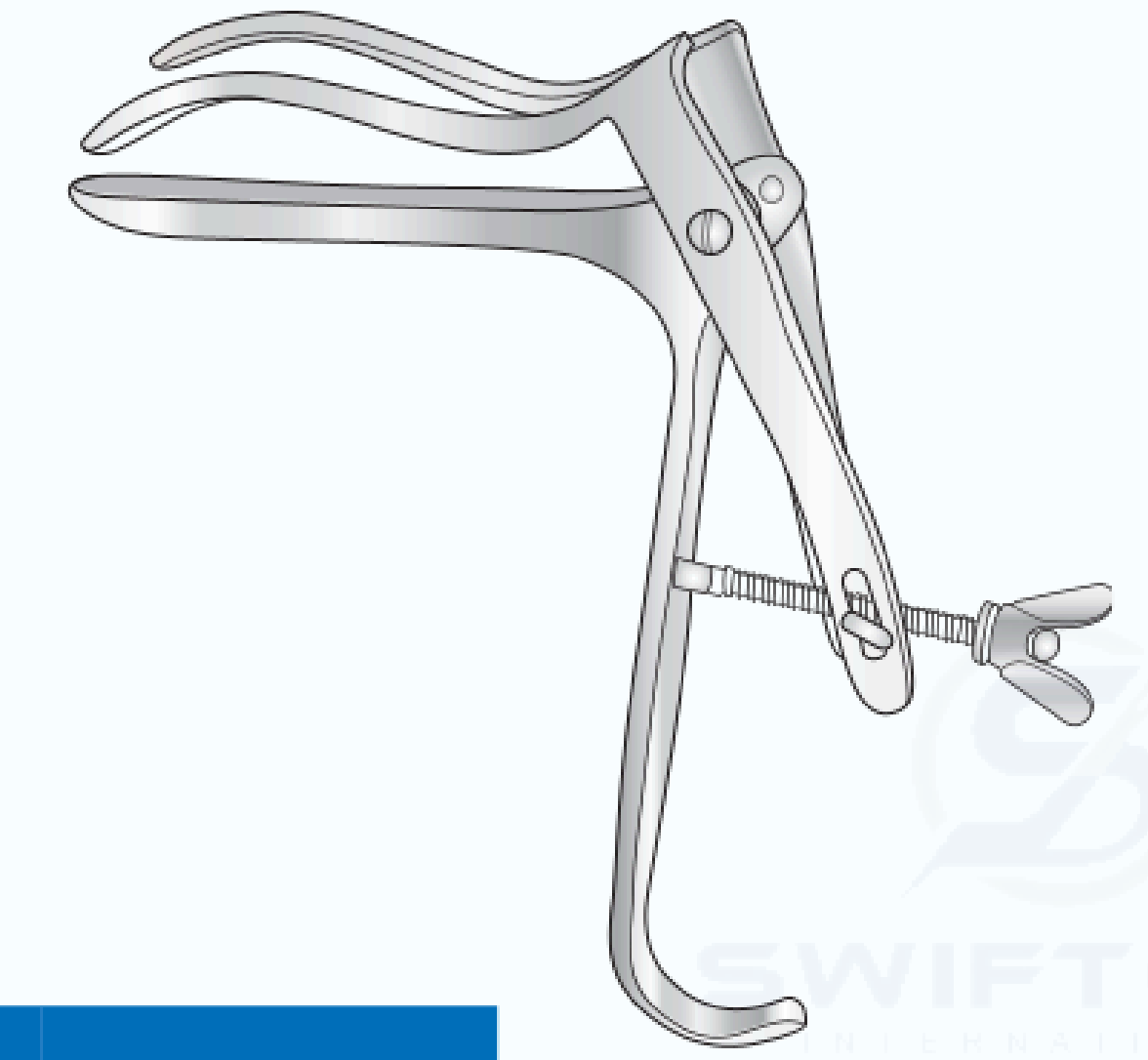

SC-GY/04102	Blade 110mm long, 30mm wide
-------------	-----------------------------

Pederson Vaginal Speculum

Stainless steel

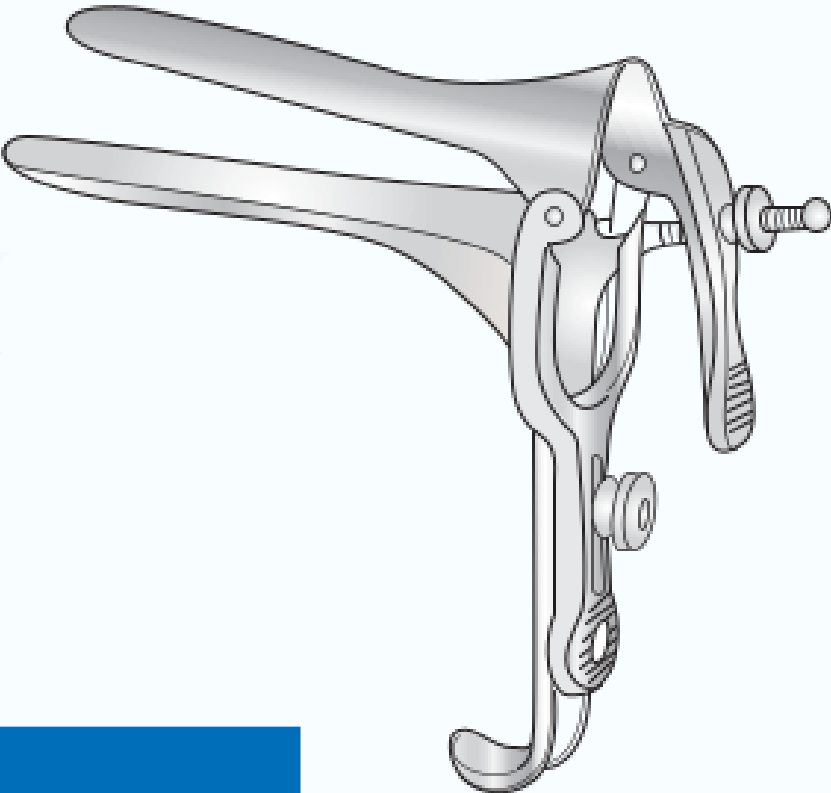

S C- G Y/07 B	120mm x 25mm wide
SC-GY/078a	90mm x 20mm wide

Winterton Vaginal Speculum

Stainless steel

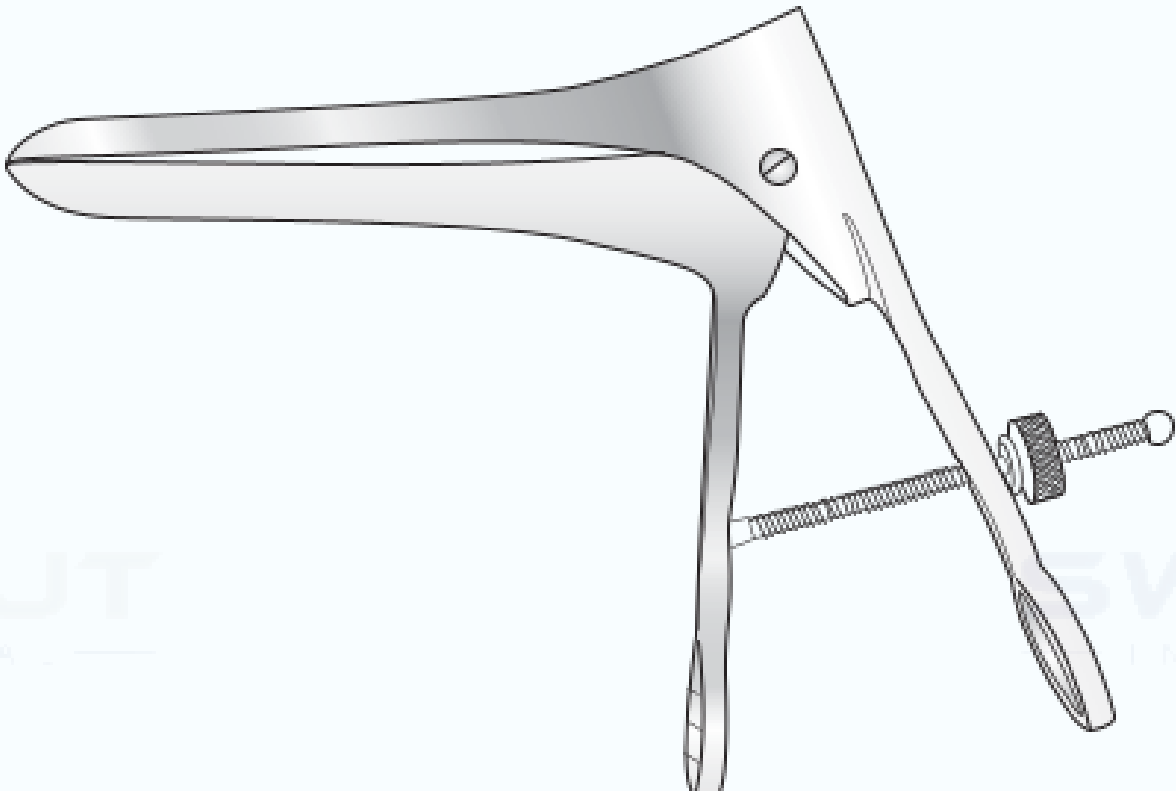

S C- G Y/074	Blade 115mm long, 25mm wide
--------------	-----------------------------

Modified Speculum

Stainless steel, for elderly patients

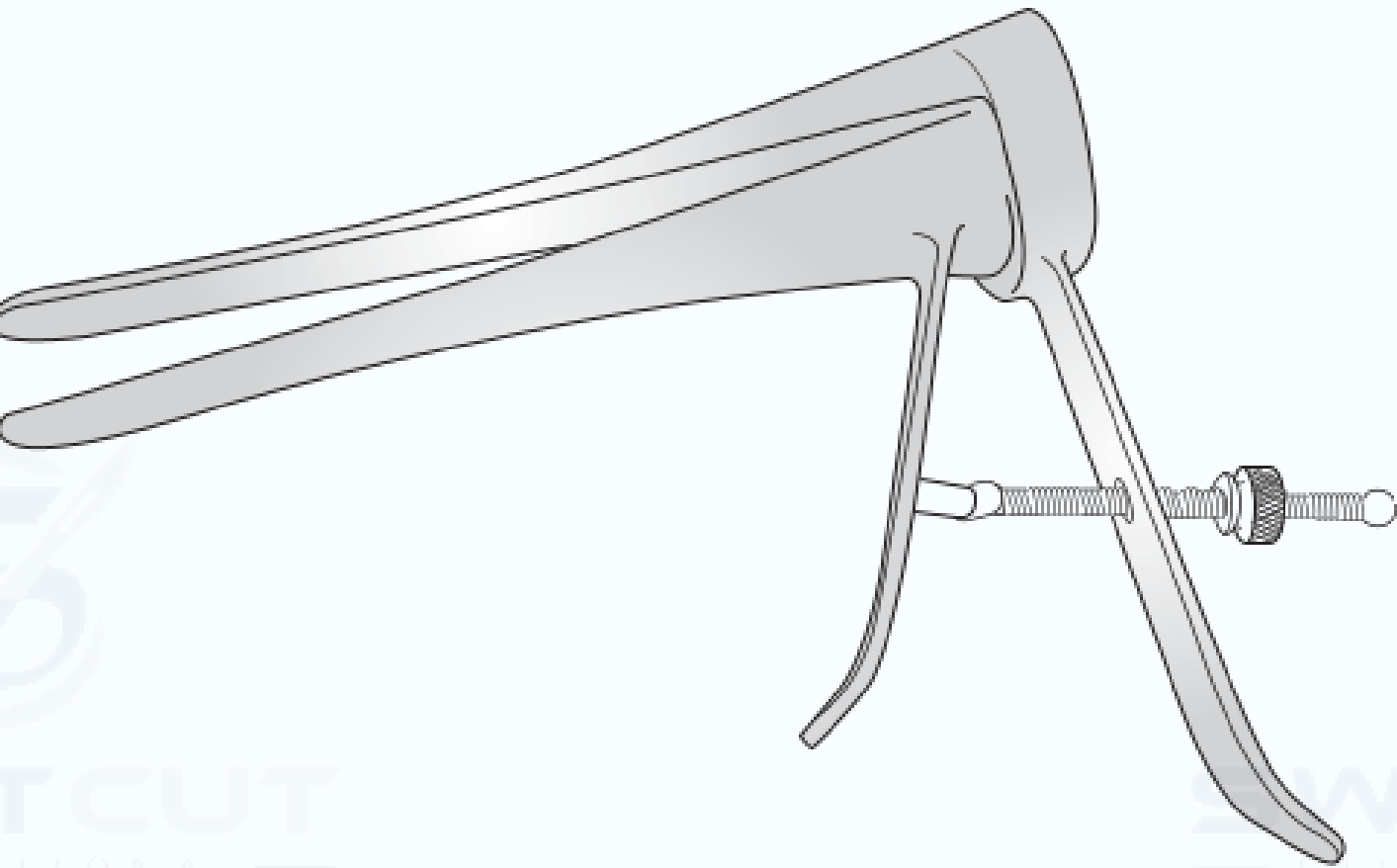

S C- G Y/074 a	Blade 180mm long, 18mm wide
----------------	-----------------------------

Sims Duckbill Speculum

Double ended

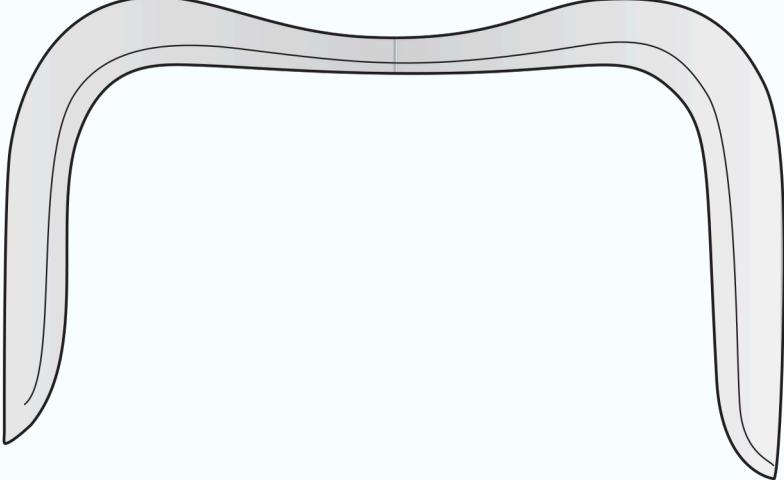

SC-GY/012a	Small - 27mm x 29mm x 130mm long
SC-GY/012b	Medium - 30mm x 33mm x 158mm long
SC-GY/012c	Large - 33mm x 38mm x 184mm long

Sims Duckbill Speculum

Double ended, insulated

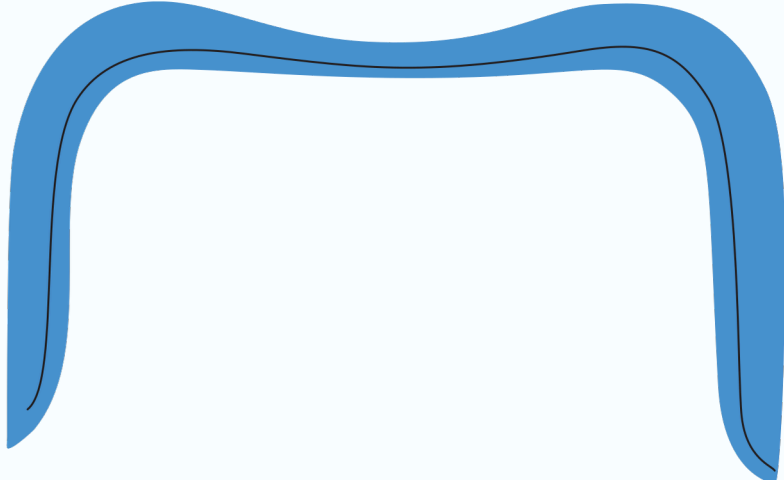

SC-DIA/031	Small - 27mm x 29mm x 130mm long
SC-DIA/032	Medium - 30mm x 33mm x 158mm long
SC-DIA/033	Large - 33mm x 38mm x 184mm long

Breisky Vaginal Retractor

Bright finish, matt handle
320mm long

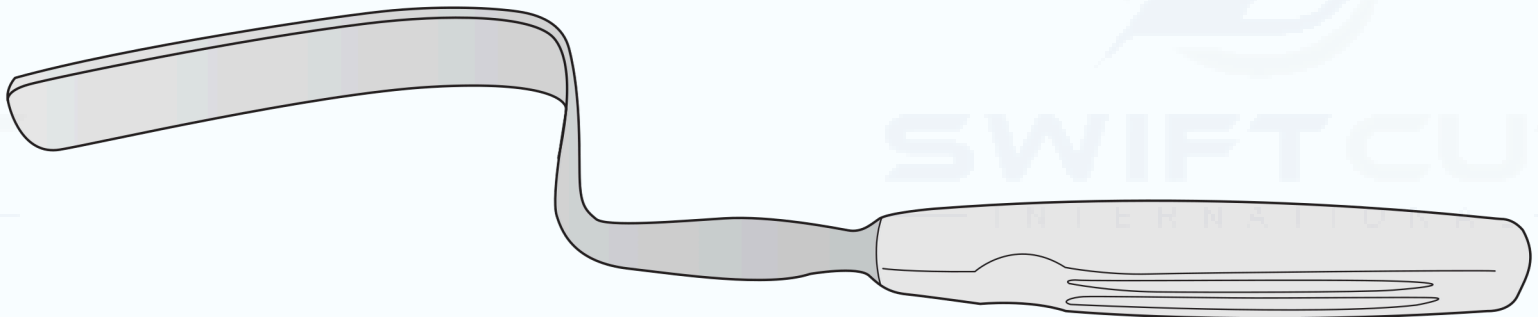

SC-GY/110	25mm blade
-----------	------------

Doyen Rectangular Retractor

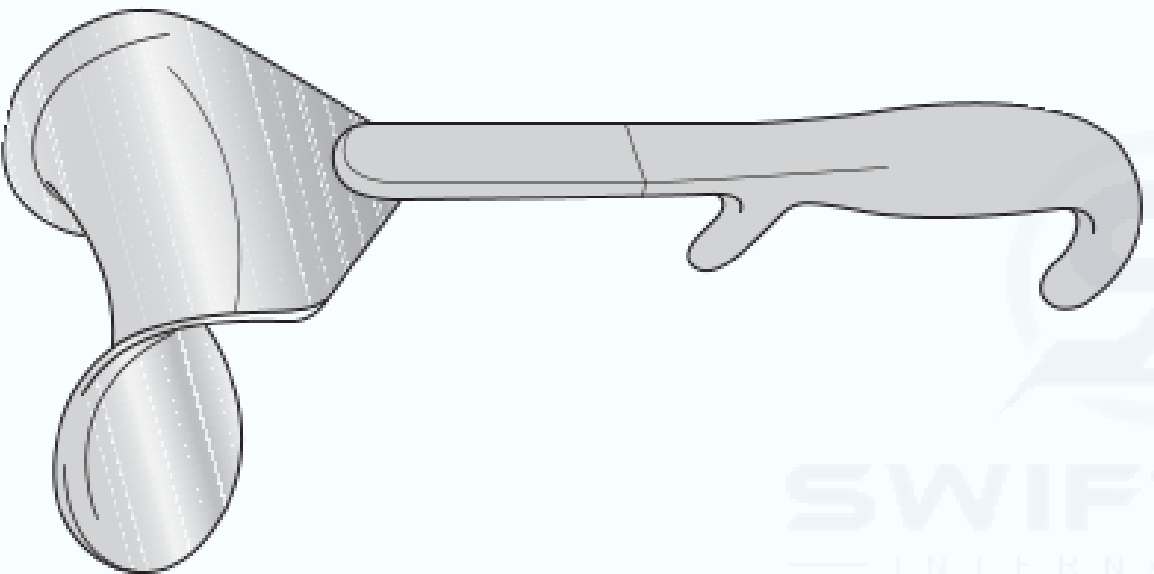

SC-GY/008a	Small - 48 x 60mm
SC-GY/008b	Medium - 48 x 89mm
SC-GY/008c	Large - 48 x 124mm

Doyen Retractor

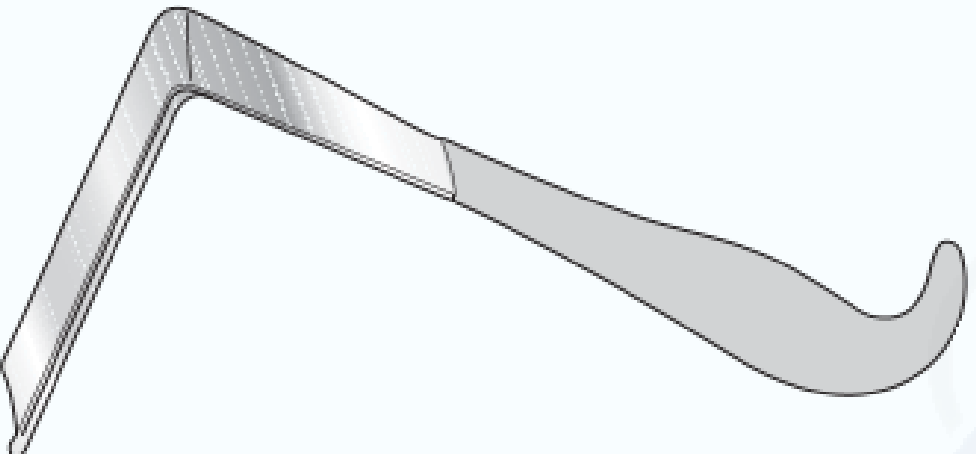

SC-GY/009a	Blade 95mm x 27mm
------------	-------------------

Doyen Retractor

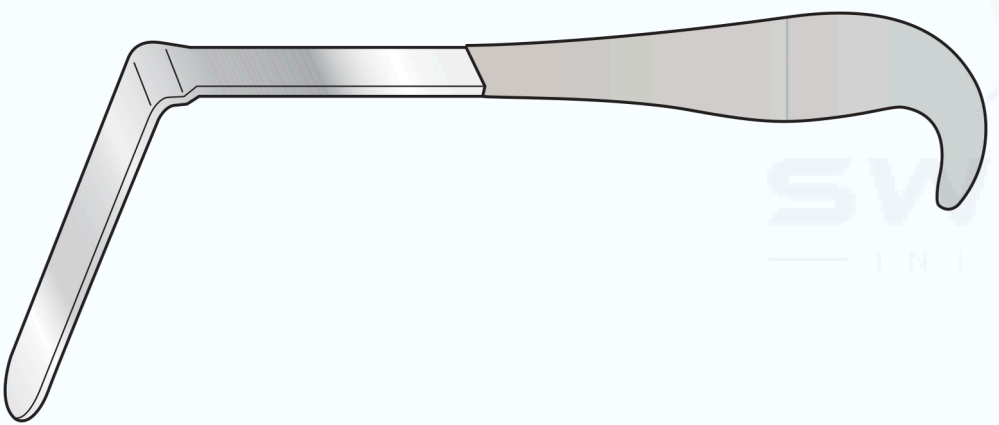

SC-GY/009b	Blade 100mm x 30mm
------------	--------------------

St Mark's Hospital Pattern Retractor

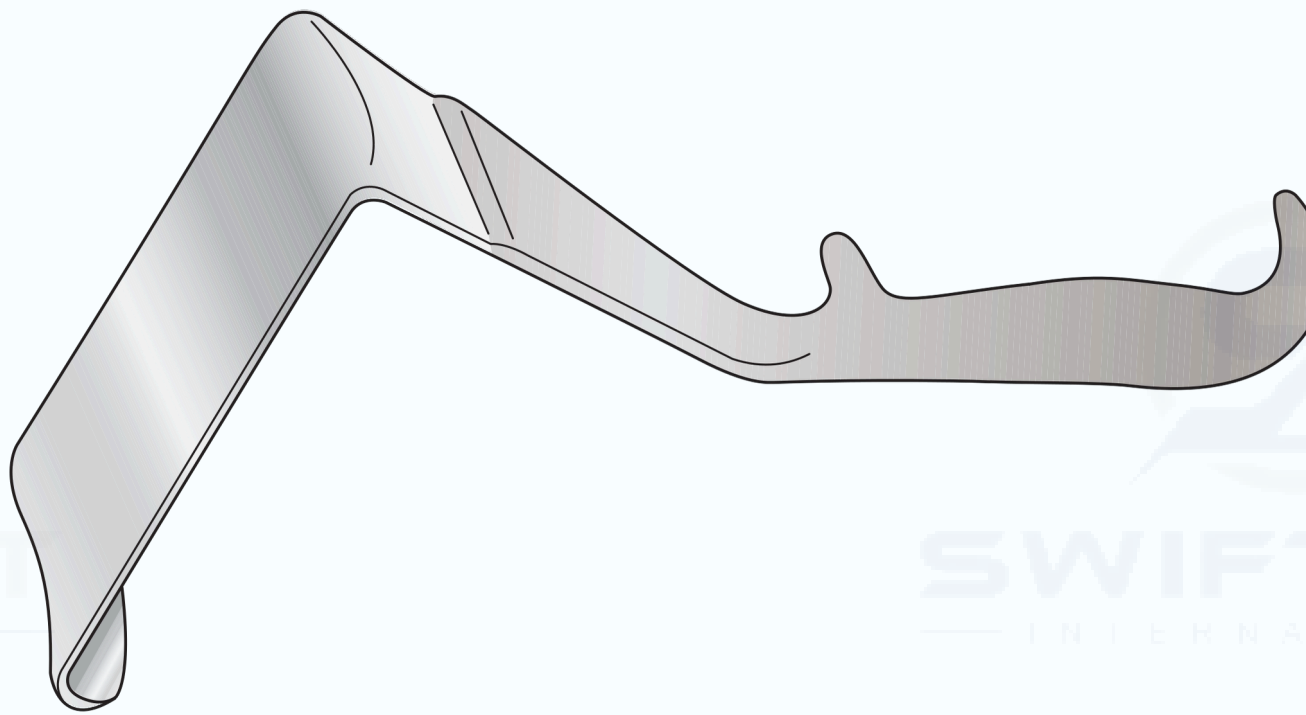

With lip		Without lip	
SC-GY/065	Blade 125mm x 60mm	SC-GY/067	Blade 125mm x 60mm
SC-GY/066	Blade 175mm x 60mm	SC-GY/068	Blade 175mm x 60mm

Wertheim Retractor

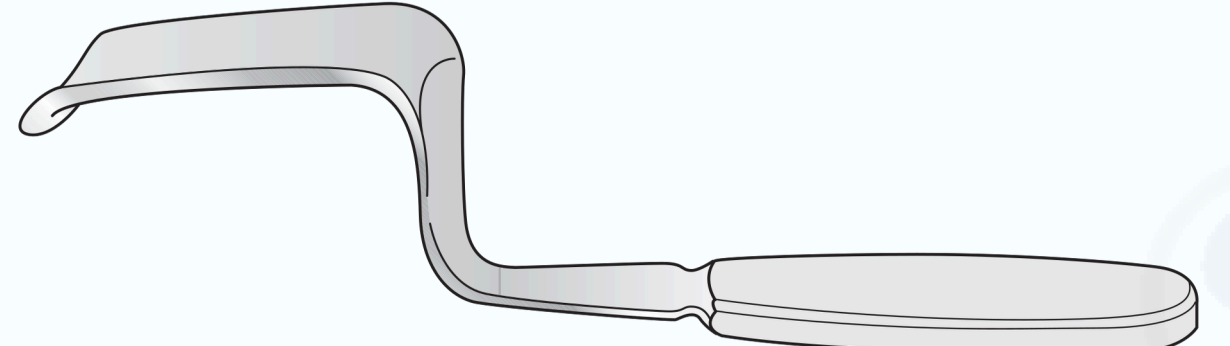

SC-GY/010	Blade 95mm x 38mm
-----------	-------------------

Landon Vaginal Retractor

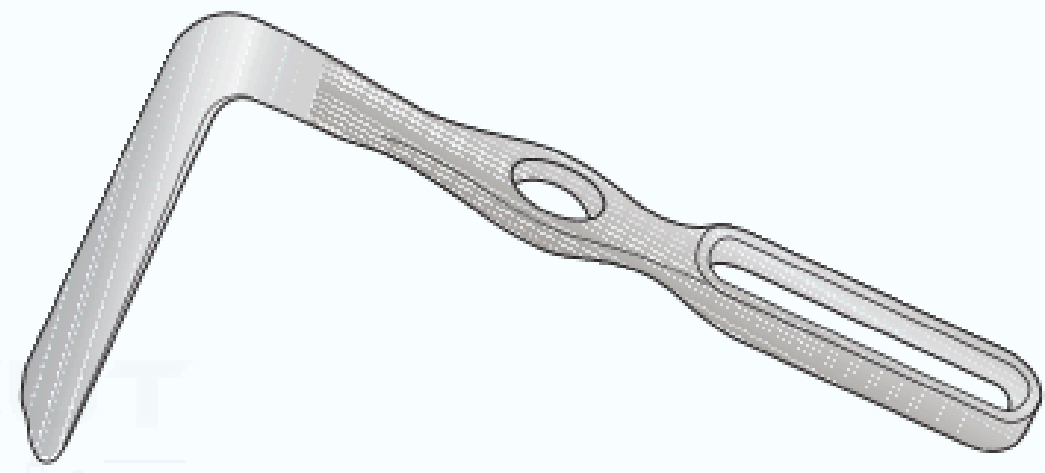

SC-GY/011	Blade 89mm x 25mm
-----------	-------------------

Lateral Vaginal Retractor

Blades bright finish, matt handle

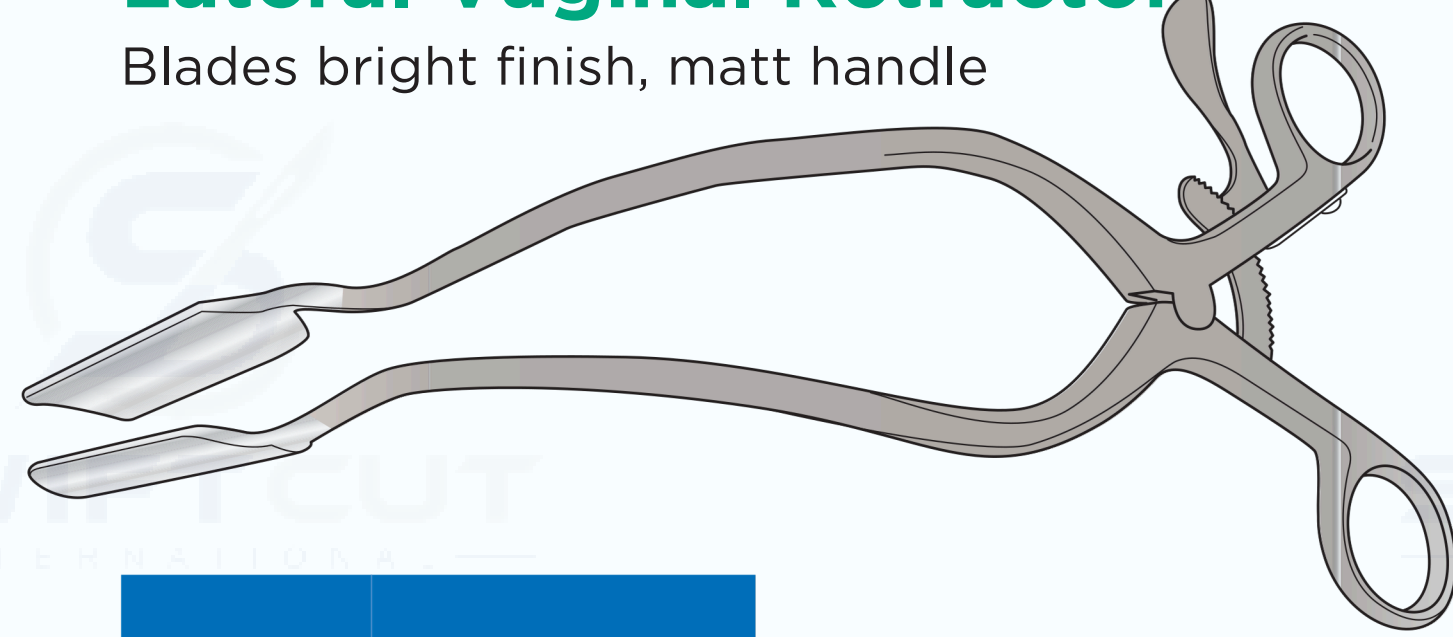

SC-GY/128	60 x 20mm blade
SC-GY/128a	75 x 22mm blade
SC-GY/128b	110 x 23mm blade

AVAILABLE INSULATED
ADD SUFFIX 'INS'

Whitlow Retractor

Vaginal retractor, for use with supplied blades. Points of retraction move around almost 360°. Supplied complete with sterilising basket and three sets of blades.

Frame

225mm at widest point

Blades

1 x anterior and 1 x posterior 90°, 25mm x 100mm
2 x lateral 90°, 25mm x 70mm
2 x lateral 75°, 25mm x 70mm

SC-GY/084

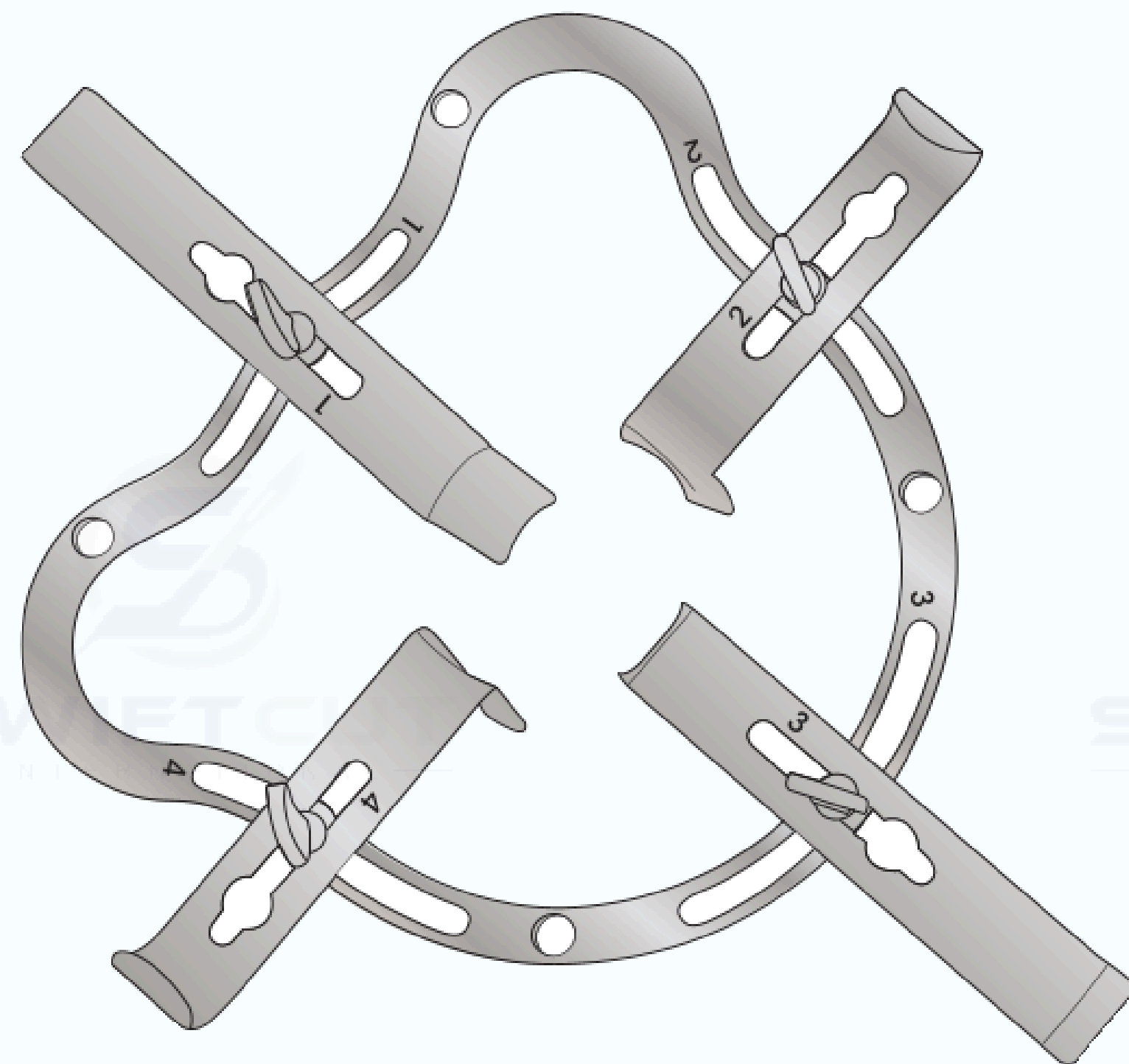
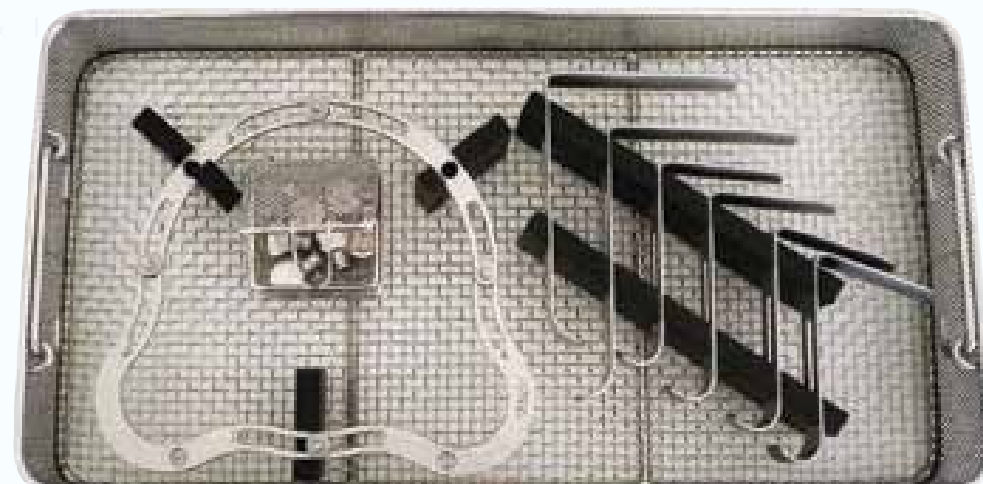

Kevorkian Biopsy Curette

313mm long

SC-GY/105	With basket
SC-GY/127	Without basket



Novak Curette

SC-GY/119	230mm long
-----------	------------



Recamier Uterine Curette

Matt finish, 310mm long

SC-GY/108	Blunt
SC-GY/109	Sharp

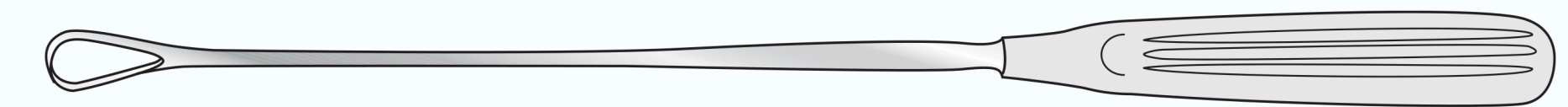

Rheinstadter Flushing Curette

290mm long

Sharp

SC-GY/076a	Sharp, 8mm
SC-GY/076b	Sharp, 14mm

Blunt

SC-GY/076c	Blunt, 8mm
SC-GY/076d	Blunt, 14mm

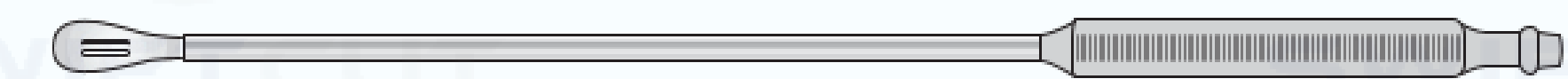

Sims Uterine Curette

Single ended, 255mm long, matt finish

Sharp

SC-GY/075a	Small 6mm
SC-GY/075b	Medium 10mm
SC-GY/075c	Large 13mm

Blunt

SC-GY/075d	Small 6mm
SC-GY/075e	Medium 10mm
SC-GY/075f	Large 13mm



Sims Uterine Curette

Double ended, 250mm long

Sharp

SC-GY/044	Small 7 x 5mm
SC-GY/045	Medium 10 x 7mm
SC-GY/046	Large 13 x 10mm

Blunt

SC-GY/047	Small 7 x 5mm
SC-GY/048	Medium 10 x 7mm
SC-GY/049	Large 13 x 10mm



Rotunda Hospital Pattern Catheter Catheter

With solid end, chromium plated, 203mm long

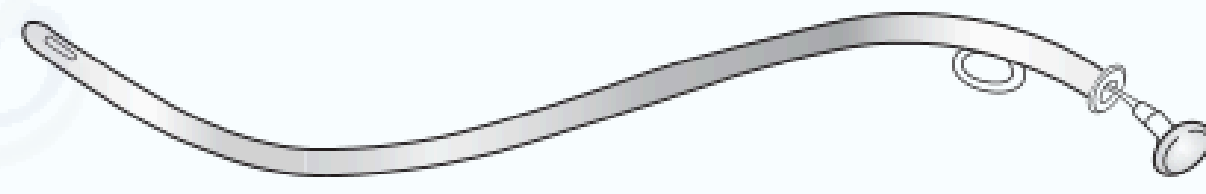

SC-GY/035a	8 E.G.
SC-GY/035b	10 E.G.

Catheter
Oval, solid end, chromium plated



SC-GY/034	165mm long
-----------	------------

Catheter Introducer

457mm long



S C- G Y/071	Straight, 2mm ø
SC-GY/071a	Curved, 2mm ø

Catheter Introducer



SC-GY/071b	Fine, 395mm long
------------	------------------

Catheter Introducer

Bulbous end, with eye in handle



SC-GY/071c	Curved, 2mm x 410mm long
------------	--------------------------

Catheter Introducer

With eye in handle, curved



SC-GY/071d	2mm x 420mm long
------------	------------------

Catheter Introducer

Fixed handle



SC-GY/071e	445mm long
------------	------------

Catheter Introducer



SC-GY/071f	400mm long
------------	------------

Catheter Introducer

410mm long



SC-GY/071g	410mm long
------------	------------

Barnes Episiotomy Scissors

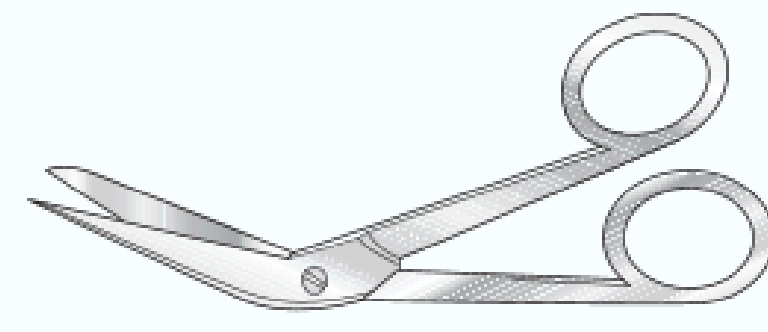

SC-GY/032	127mm long
-----------	------------

Braun Stadler Episiotomy Scissors

Matt finish

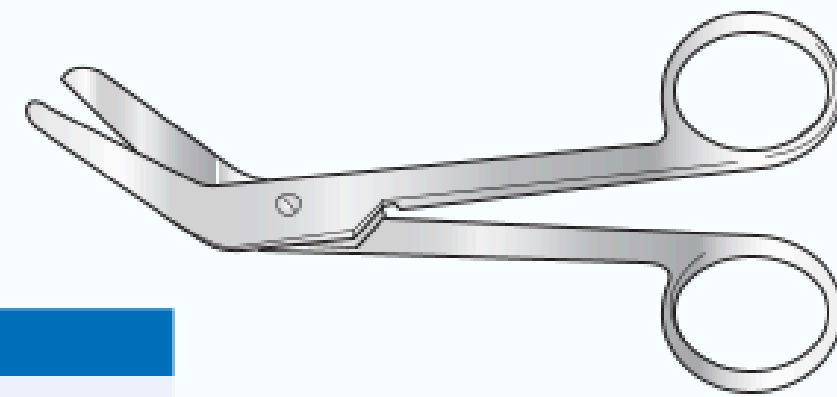

SC-	140mm
GY/063	long
SC-	222mm
GY/064	long

Vant Episiotomy Scissors



SC-GY/033	76mm blades, 241mm long
-----------	-------------------------

Busch Umbilical Scissors

Matt finish

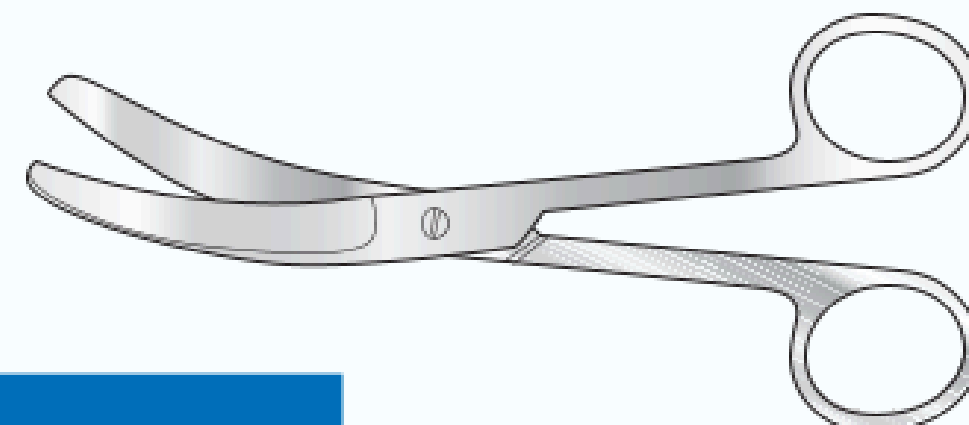

SC-GY/116	160mm long
-----------	------------

Umbilical Scissors

American pattern

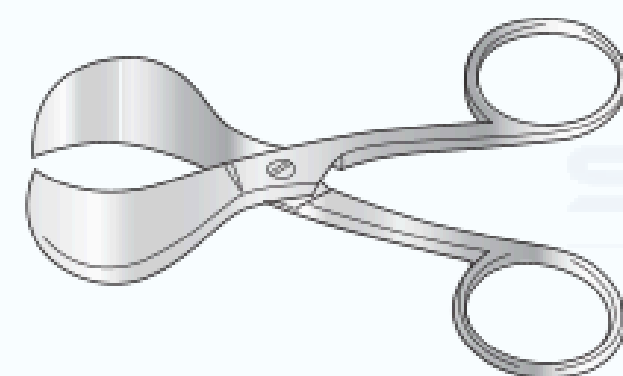

SC-GY/031	102mm long
-----------	------------

Simms Uterine Scissors

Curved, tungstencarbide, with two gold bows

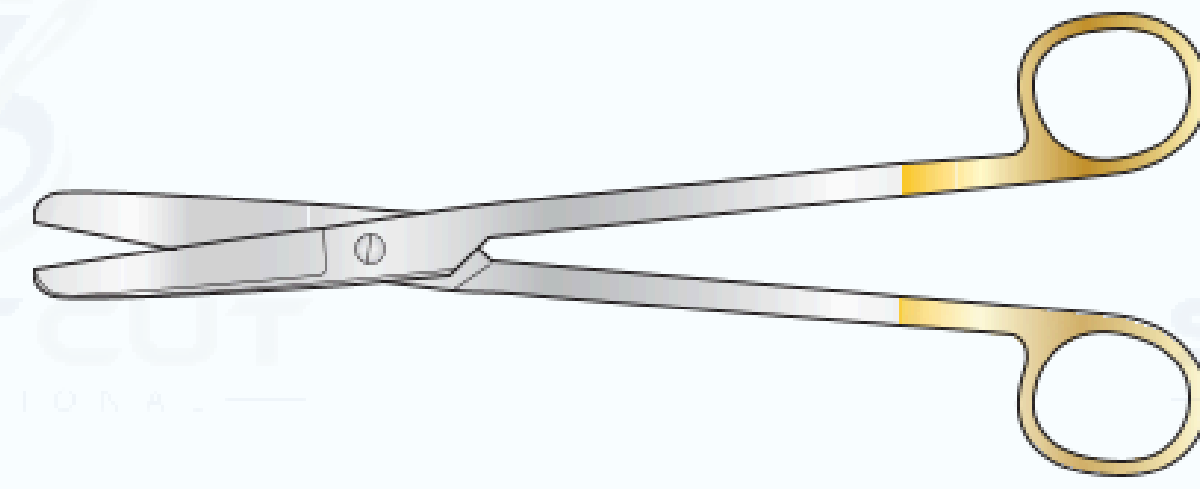

SC-GY/115	200mm long
-----------	------------

Dubois Uterine Scissors

Matt finish

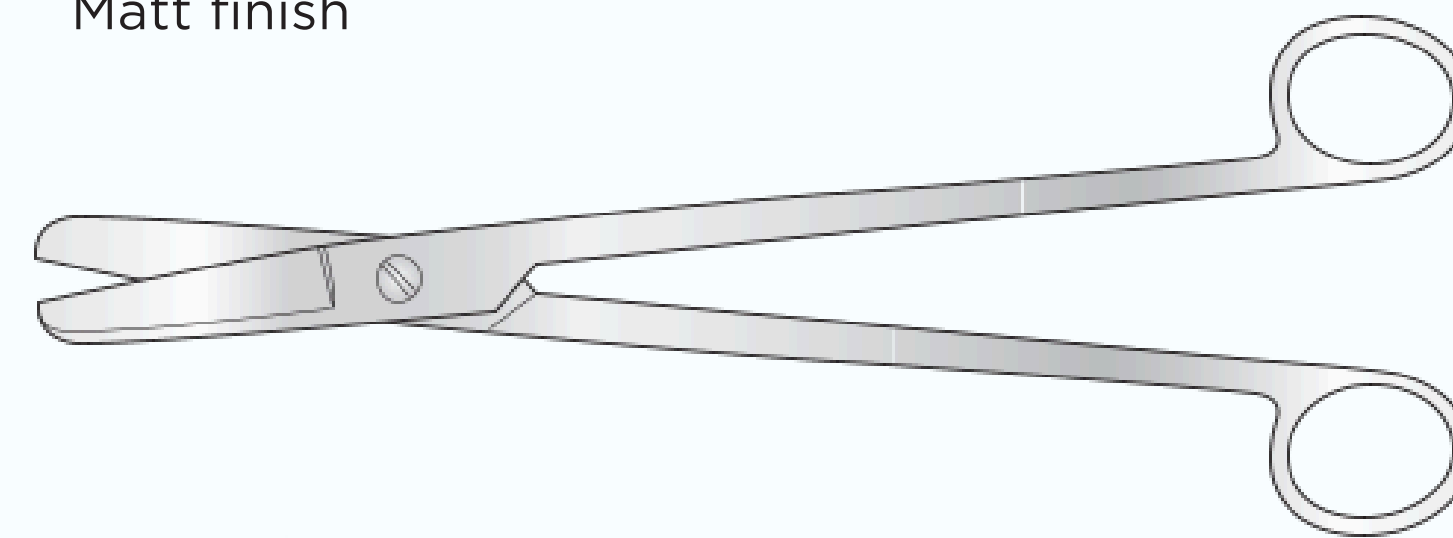

SC-GY/114	270mm long
-----------	------------

Uterine Scissors

Curved on flat

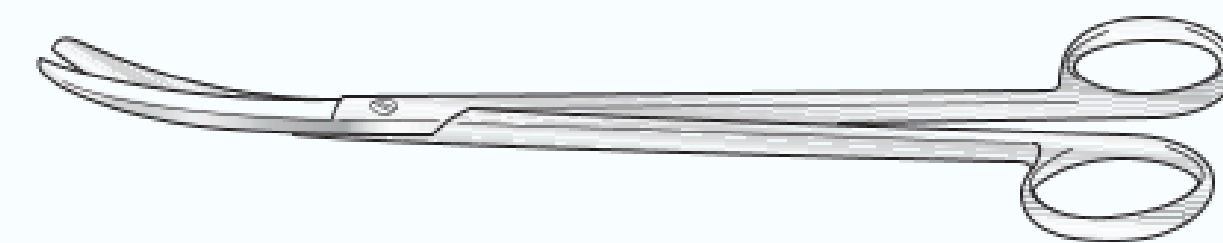

SC-GY/030a	203mm long
------------	------------

Uterine Scissors

Angled on flat

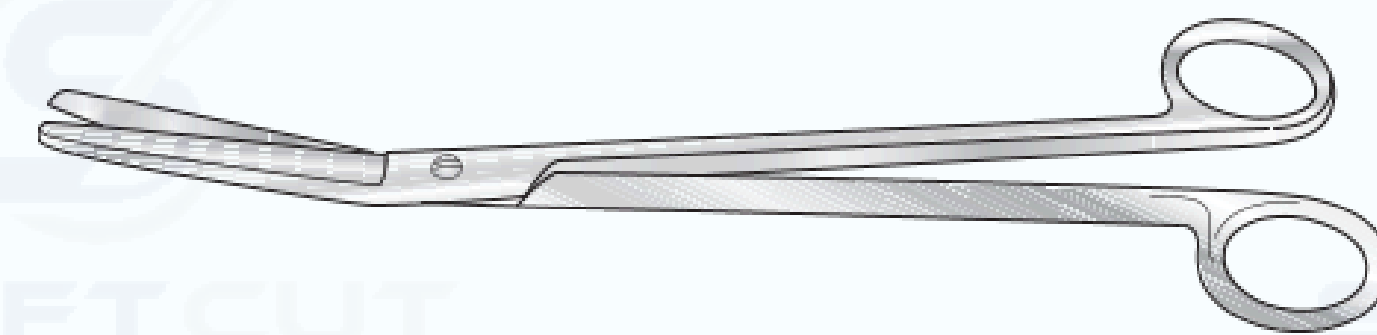

SC-GY/030b	230mm long
------------	------------

Parametrium Scissors

225mm long

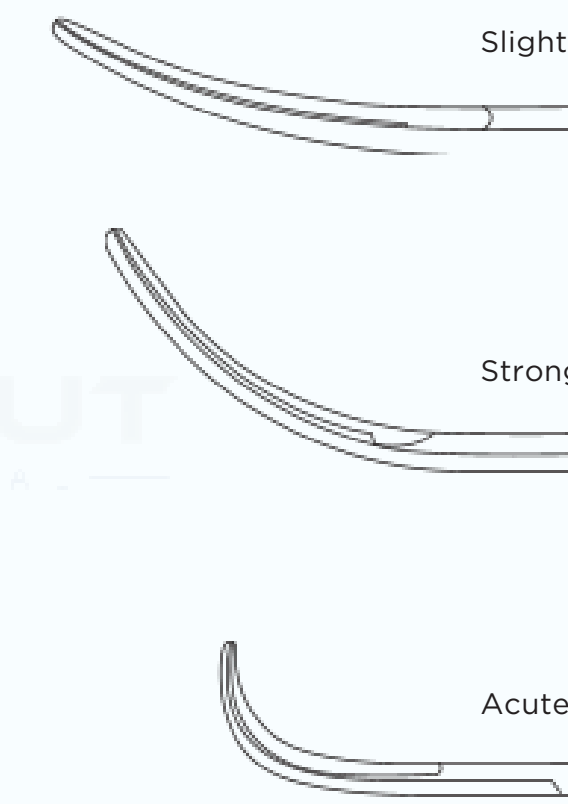
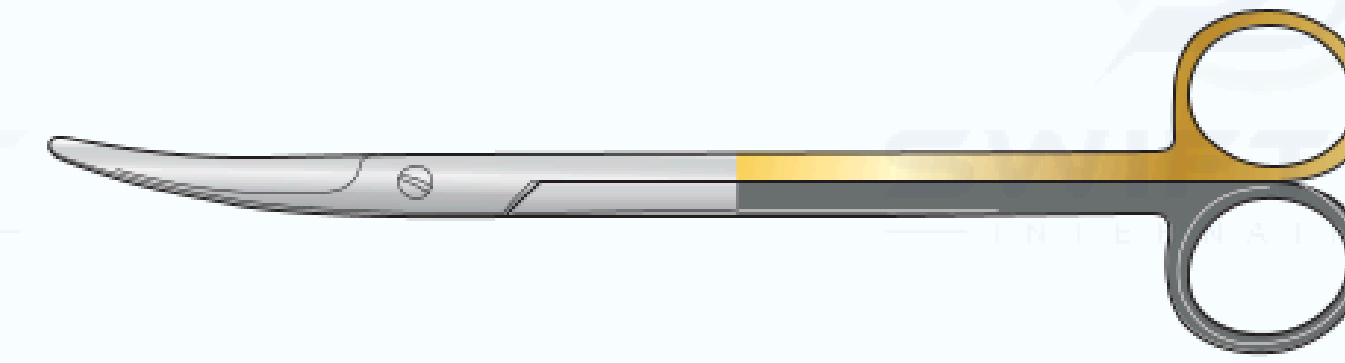

Tungsten carbide, standard, with two gold bows

SC-GY/080	Slight curve
SC-GY/080a	Strong curve
SC-GY/080b	Acute curve

Tungsten carbide, supercut, with one gold and one black bow

SC-GY/081	Slight curve
SC-GY/081a	Strong curve
SC-GY/081b	Acute curve

Miscellaneous

Bonney Myomectomy Clamp

With 51mm jaws, screw joint

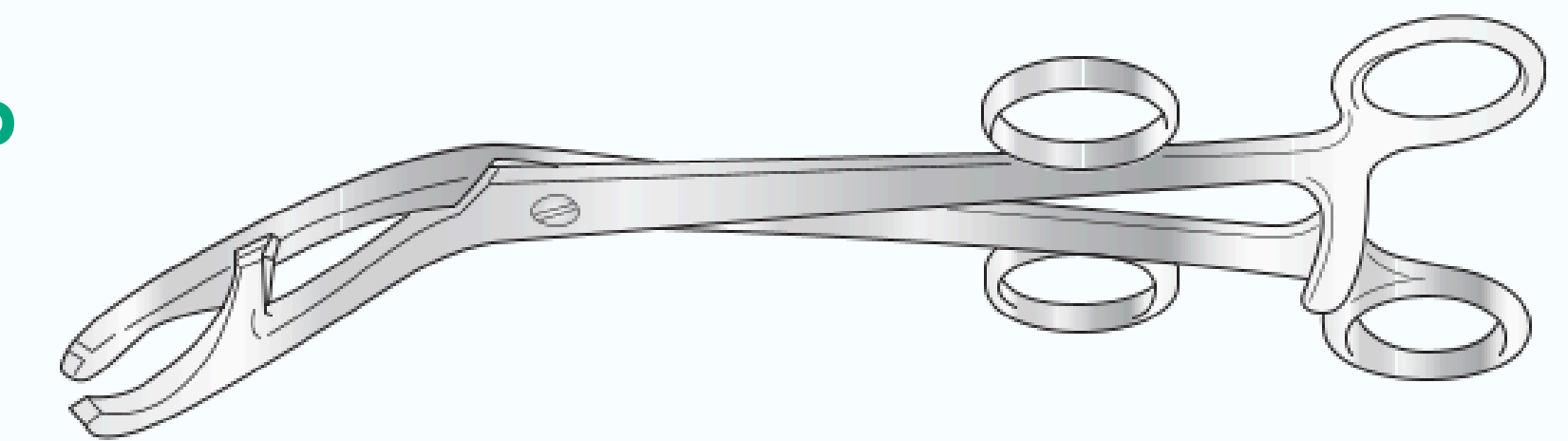

SC-GY/004	267mm long
-----------	------------

Sims Vaginal Depressor

Doubled ended

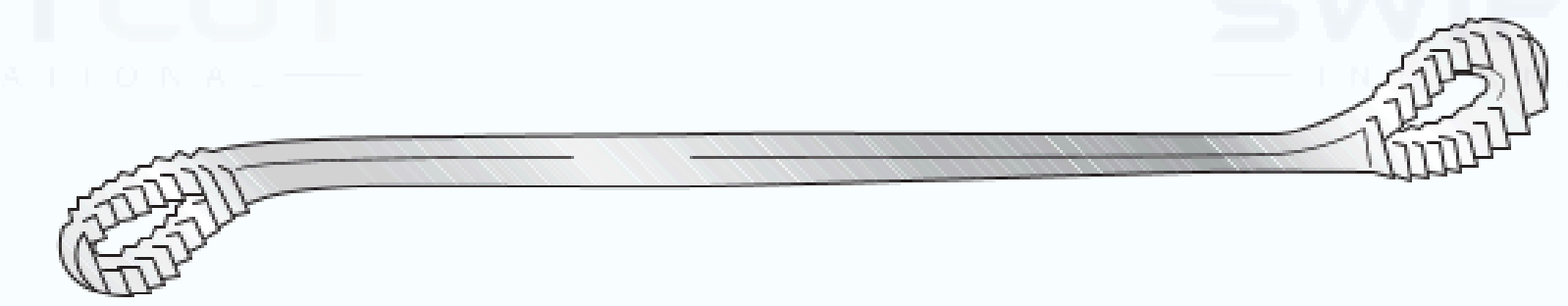

SC-GY/039	260mm long
-----------	------------

Spackman Uterine Cannula

Chromeplated, 360mm long

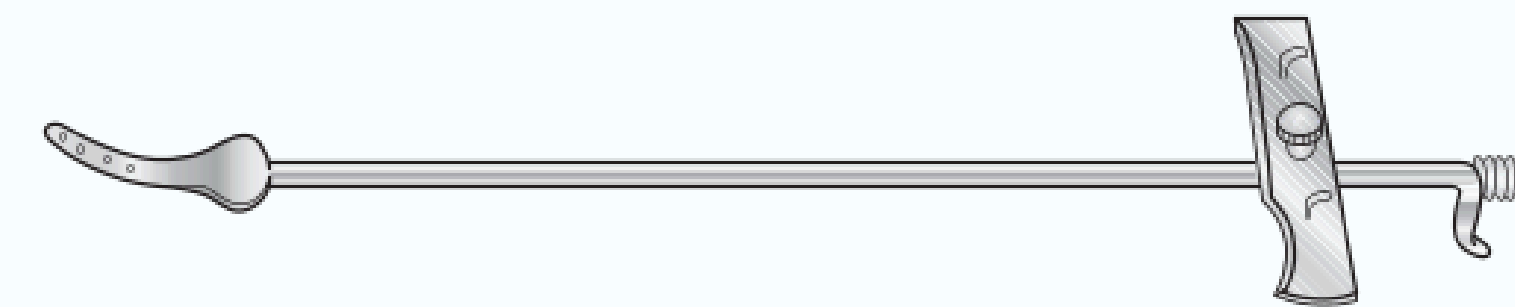

SC-GY/040	12 F.G. with rubber cone
SC-GY/040a	14 F.G. with metal cone
SC-GY/040b	14 F.G. with rubber cone
SC-GY/040c	18 F.G. with metal cone
SC-GY/040d	18 F.G. with rubber cone

Doyen Myoma Screw Large



SC-GY/006a	178mm long
------------	------------

Doyen Myoma Screw Small



SC-GY/006b	178mm long
------------	------------

Lake Seeker

Double ended, for vestibule

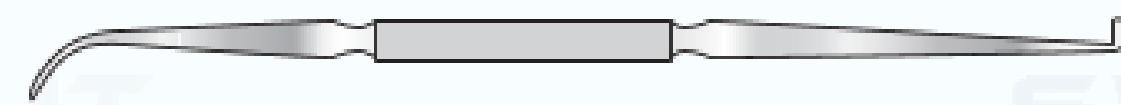

SC-ENT/040	184mm long
------------	------------

Lempert Rugine

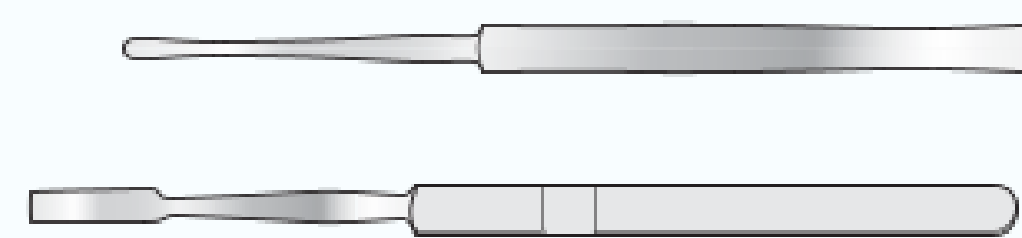

SC-ENT/064a	Narrow, 156mm long
SC-ENT/065a	Broad, 171mm long

Irwin-Moore Tonsil Needle

203mmlong

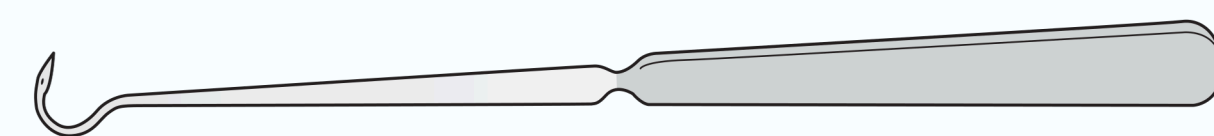

SC-ENT/164a	Curved to right
SC-ENT/164a	Curved to left

Negus Pusher

“Knottier”, metal handle

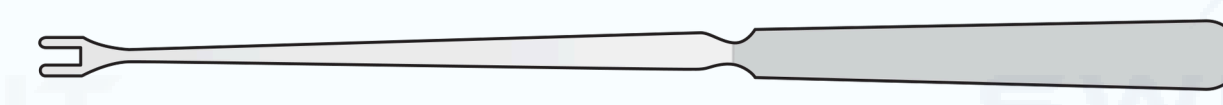

SC-ENT/165	203mm long
------------	------------

Stanford Cade Insufflator

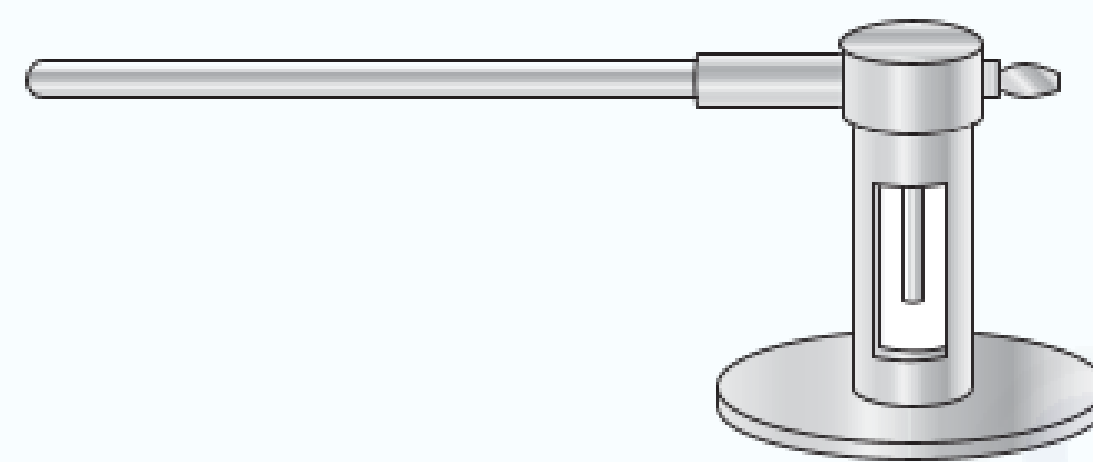

SC-ENT/188	175mm long
------------	------------

Tubing Mount

Foruse with catheters, Luer



SC-ENT/016	25mm
------------	------

Galabin Uterine Sound

Calibrated 4-24, bright finish

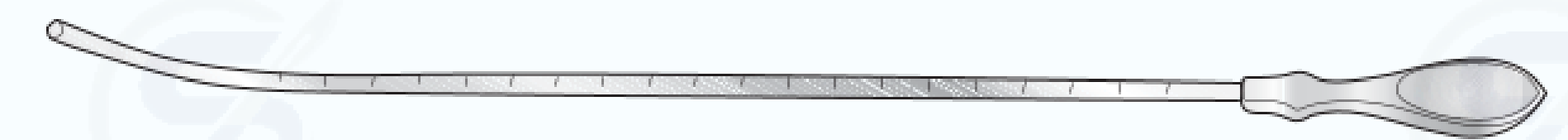

SC-GY/106	305mm long
-----------	------------

Sims Uterine Sound

Calibrated 4-24, bright finish

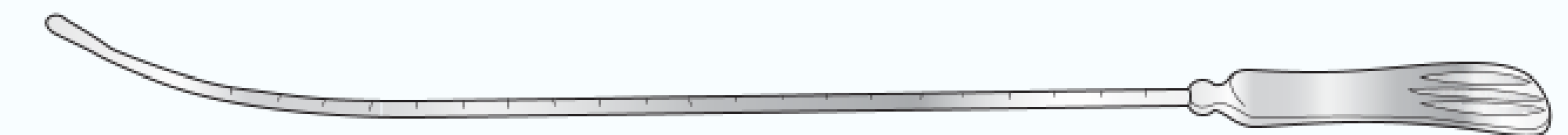

SC-GY/107	320mm long
-----------	------------

Umbilical Dilator

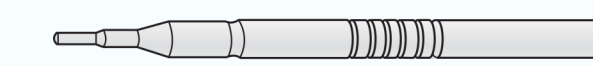

SC-GY/038	95mm long
-----------	-----------

Hawkin Ambler Cervix Dilators

Conical, 171mm long

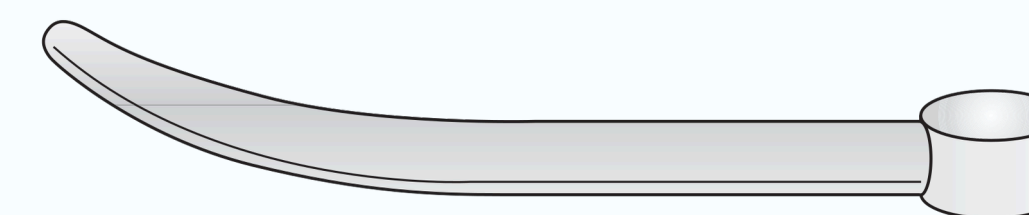

SC-GY/050	Set of 12
SC-GY/051	Size 3 - 6mm
SC-GY/052	Size 4 - 7mm
SC-GY/053	Size 5 - 8mm
SC-GY/054	Size 6 - 9mm
SC-GY/055	Size 7 - 10mm
SC-GY/056	Size 8 - 11mm

SC-GY/057	Size 9 - 12mm
SC-GY/058	Size 10 - 13mm
SC-GY/059	Size 11 - 14mm
SC-GY/060	Size 12 - 15mm
SC-GY/061	Size 13 - 16mm
SC-GY/062	Size 14 - 17mm

Hegar Cervix Dilator

Single ended, 185mm long



SC-GY/70SE1	1mm ø
SC-GY/70SE2	2mm ø
SC-GY/70SE3	3mm ø
SC-GY/70SE4	4mm ø
SC-GY/70SE5	5mm ø
SC-GY/70SE6	6mm ø
SC-GY/70SE7	7mm ø
SC-GY/70SE8	8mm ø
SC-GY/70SE9	9mm ø

SC-GY/70SE10	10mm ø
SC-GY/70SE11	11mm ø
SC-GY/70SE12	12mm ø
SC-GY/70SE13	13mm ø
SC-GY/70SE14	14mm ø
SC-GY/70SE15	15mm ø
SC-GY/70SE16	16mm ø
SC-GY/70SE17	17mm ø

Hegar Cervix Dilator

Double ended, 200mm long

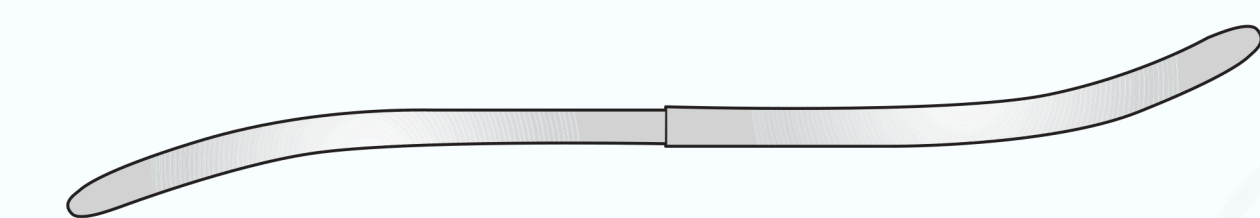

S C - G Y/070 j	Set of 8: from sizes 1 and 2mm to 15 and 16mm
SC-GY/070h	1 and 2mm ø
S C - G Y/070	3 and 4mm ø
SC-GY/070a	5 and 6mm ø
S C - G Y/070 b	7 and 8mm ø

S C - G Y/070 c	9 and 10mm ø
SC-GY/070d	11 and 12mm ø
SC-GY/070e	13 and 14mm ø
SC-GY/070f	15 and 16mm ø
SC-GY/070g	17 and 18mm ø