

GENERAL INSTRUMENTS

The essential foundation of every surgical toolkit, our General Instruments category covers the versatile, multi-purpose tools used across virtually all specialties and procedures. This collection includes fundamental instruments for tissue handling, hemostasis, cutting, dissection, suturing, and exposure—such as forceps, scissors, needle holders, retractors, and clamps. Designed for reliability, precision, and everyday durability, these instruments support the core tasks of surgery from initial incision to final closure.

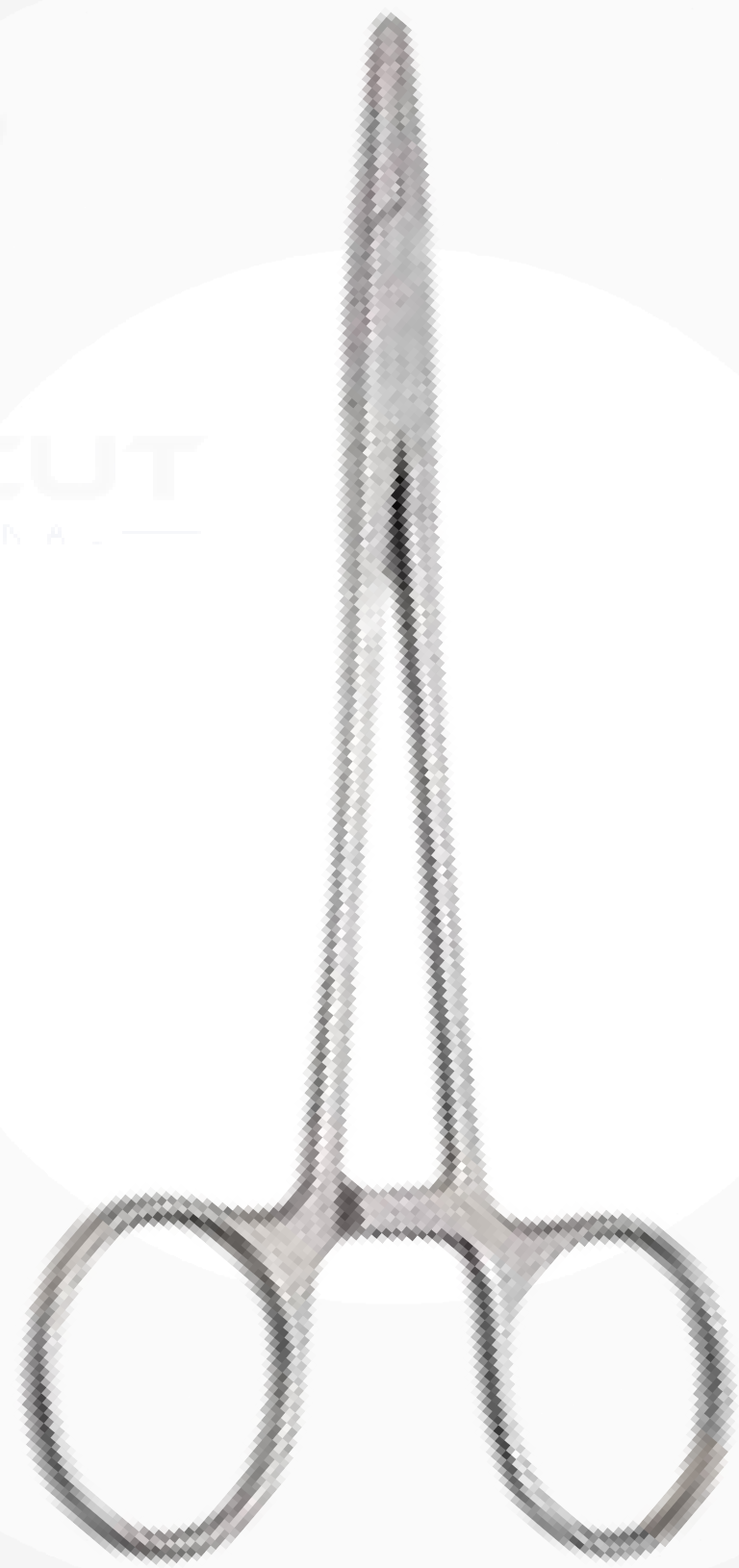

Adson Artery Forceps

Box joint, 180mm long

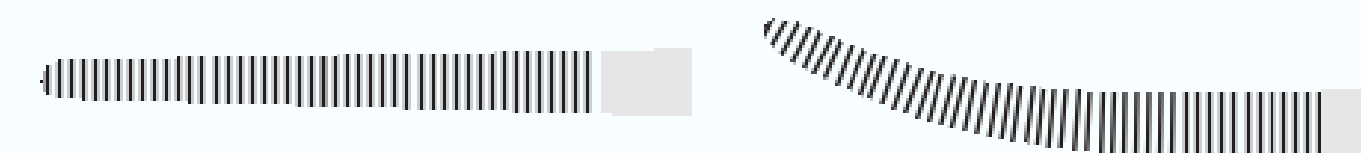
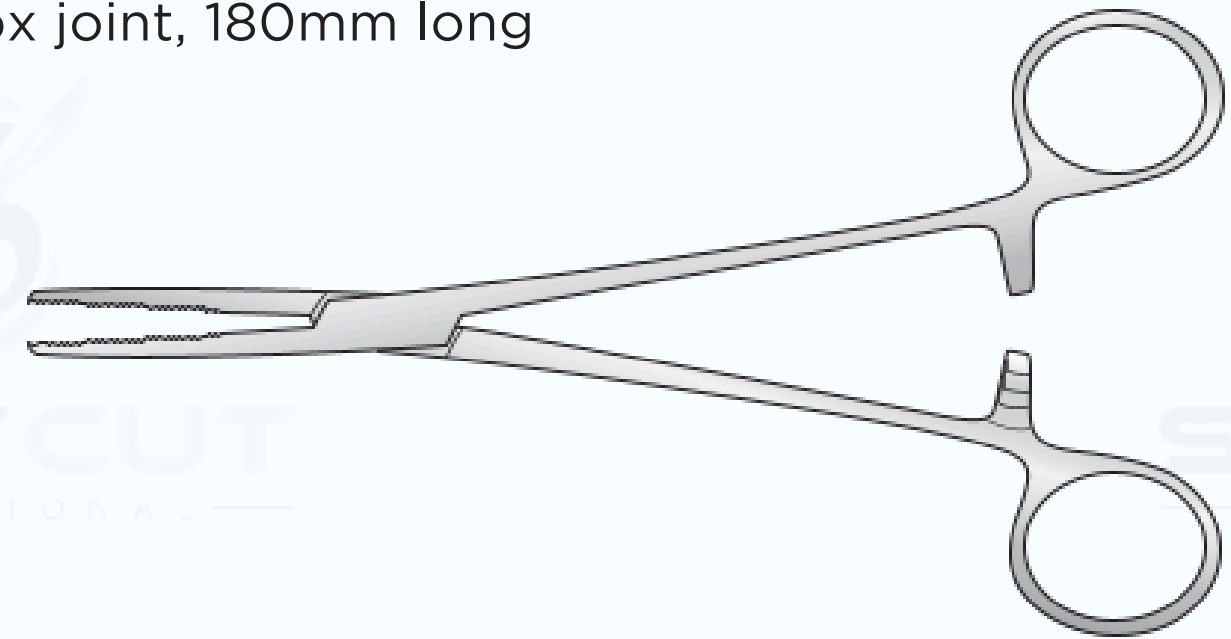

Serrated jaws

SC-GI/034	Straight
SC-GI/034a	Curved

1-2 teeth

SC-GI/034b	Straight
SC-GI/034c	Curved

Cushing Artery Forceps

Box joint, fine half serrated jaws, 140mm long

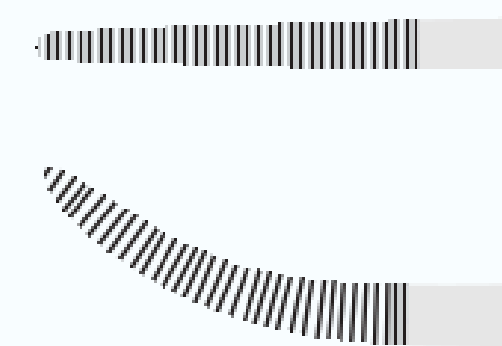
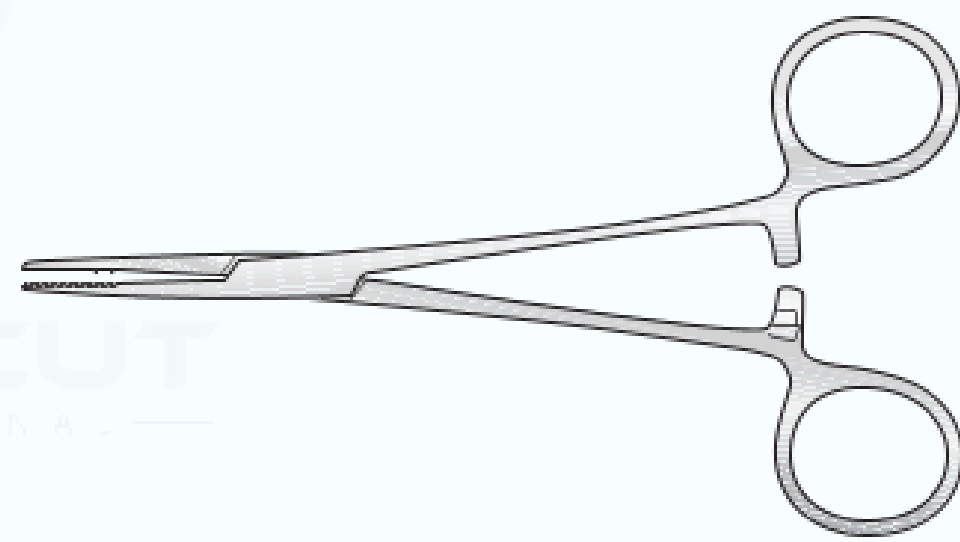

SC-GI/001	Straight
SC-GI/002	Curved

Halstead Mosquito Forceps

Standard pattern, haemostatic, box joint

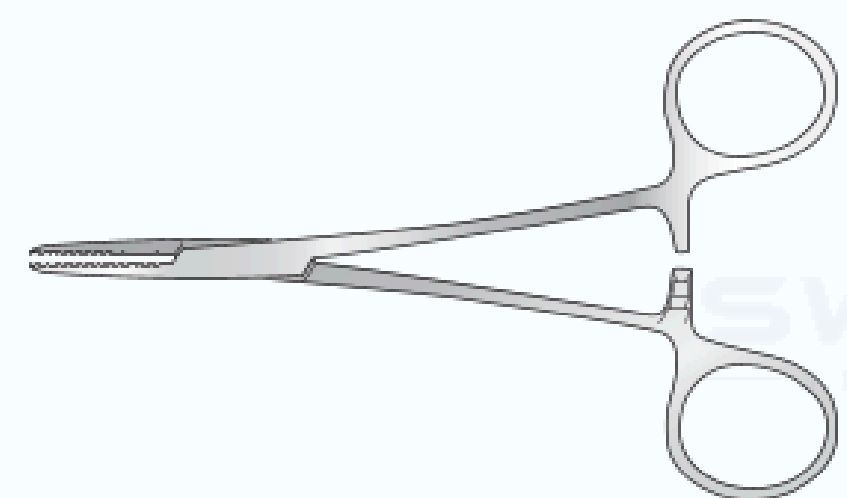

Serrated jaw

SC-GI/007	Straight 125mm long
SC-GI/008	Curved 125mm long
SC-GI/009	Fully curved 125mm long

Micro, 100mm long

-GI/003	Straight, serrated
SC-GI/004	Curved, serrated
SC-GI/005	Straight, 1-2 teeth
SC-GI/006	Curved, 1-2 teeth

1-2 teeth

SC-GI/010	Straight 125mm long
SC-GI/012	Straight 190mm long
SC-GI/011	Curved 125mm long
SC-GI/013	Curved 190mm long

Kelly Artery Forceps

Box joint, half serrated jaws

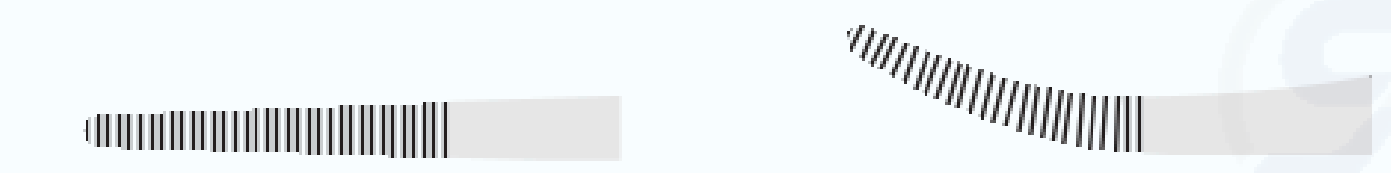

Straight

GI/022	140mm long
SC-GI/023	160mm long

Curved

-GI/024	140mm long
SC-GI/025	160mm long

Cairns Artery Forceps

Box joint, half serrated jaws 145mm long

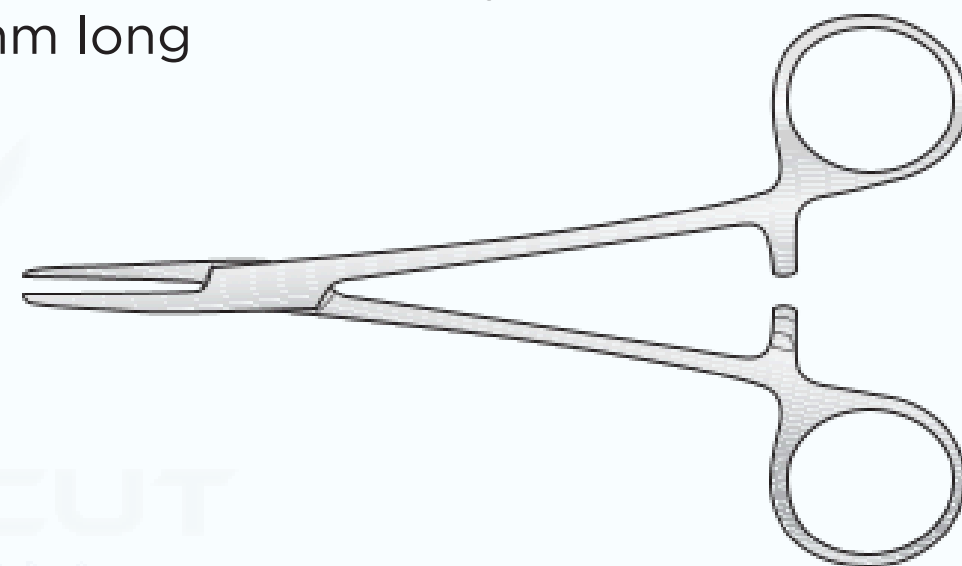

Serrated jaws

SC-GI/415	Straight
-----------	----------

1-2 teeth

SC-GI/020	Curved
SC-GI/021	Curved to side

Dunhill Artery Forceps

Box joint, fine serrations

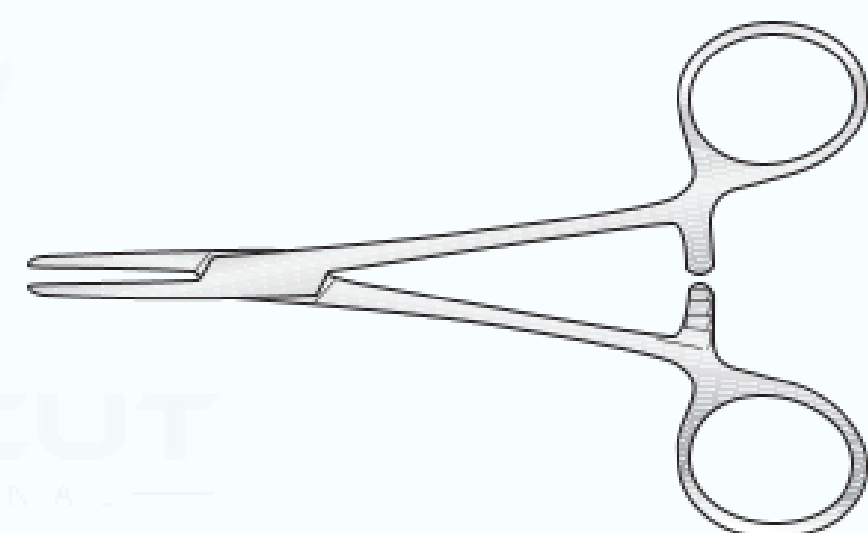

Straight

SC-GI/065	135mm long
SC-GI/065a	190mm long

Curved

GI/043	135mm long
SC-GI/468	180mm long

Heiss Artery Forceps

Box joint, 205mm long

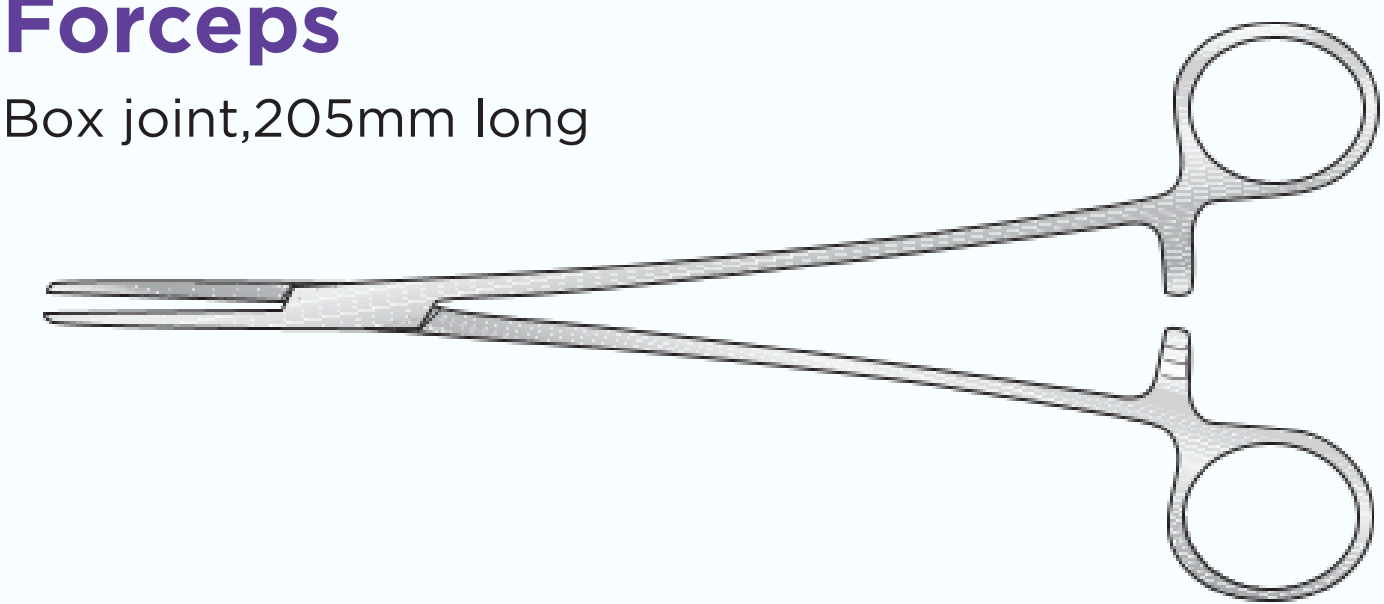

Serrated jaws

-GI/016	Straight
SC-GI/017	Curved

1-2 teeth

-GI/016a	Straight
GI/017b	Curved

Kocher Artery Forceps

Box joint, 1-2 teeth

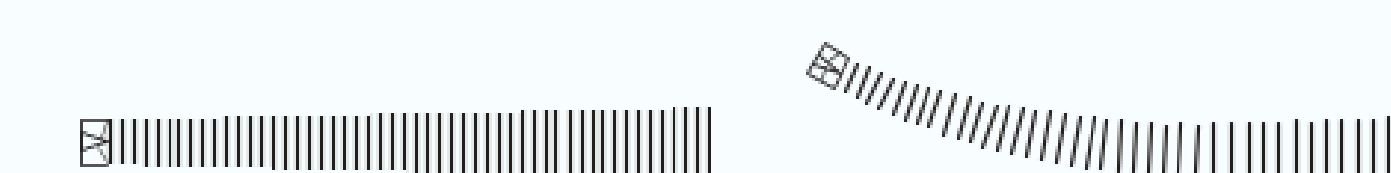
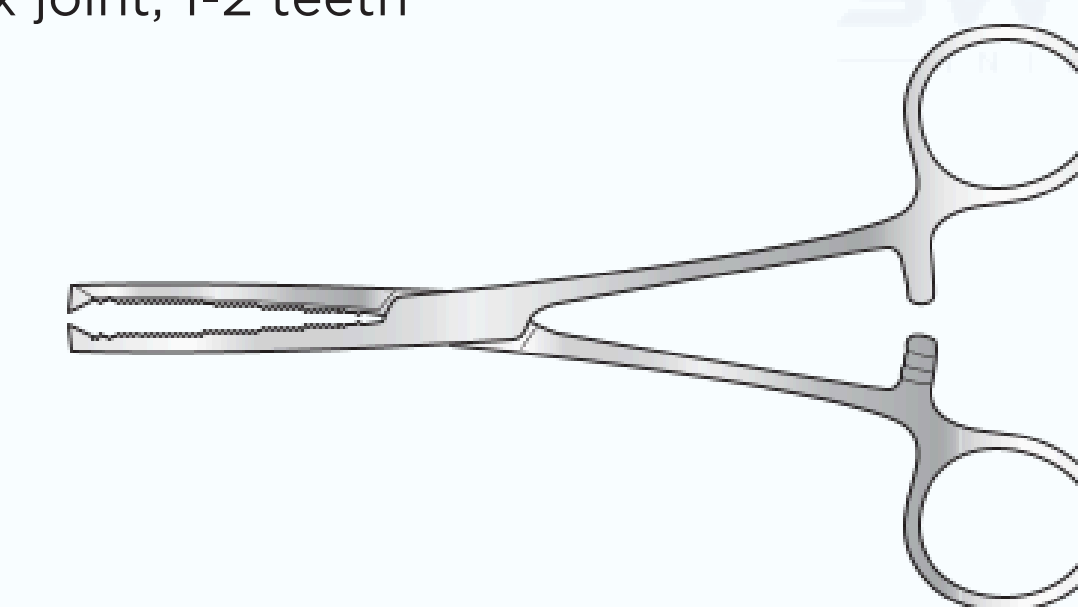

Straight

SC-GI/052	130mm long
SC-GI/053	150mm long
SC-GI/054	180mm long
SC-GI/055	200mm long
SC-GI/056	230mm long

Curved

SC-GI/057	150mm long
SC-GI/058	180mm long
SC-GI/059	200mm long
SC-GI/060	230mm long

Crile Artery Forceps

Box joint, serrated jaws

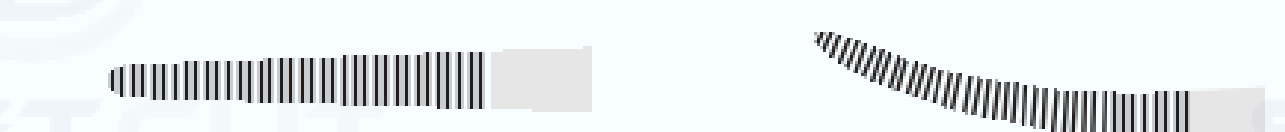
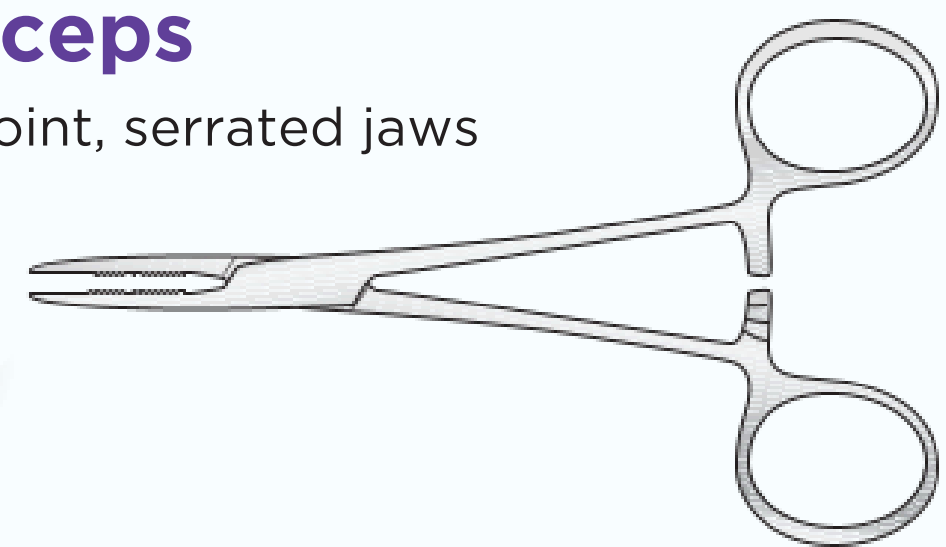

Straight

SC-GI/014	140mm long
SC-GI/014a	160mm long

Curved

SC-GI/015	140mm long
SC-GI/015a	160mm long

Lawson Tait Artery Forcep

Box joint, straight jaw

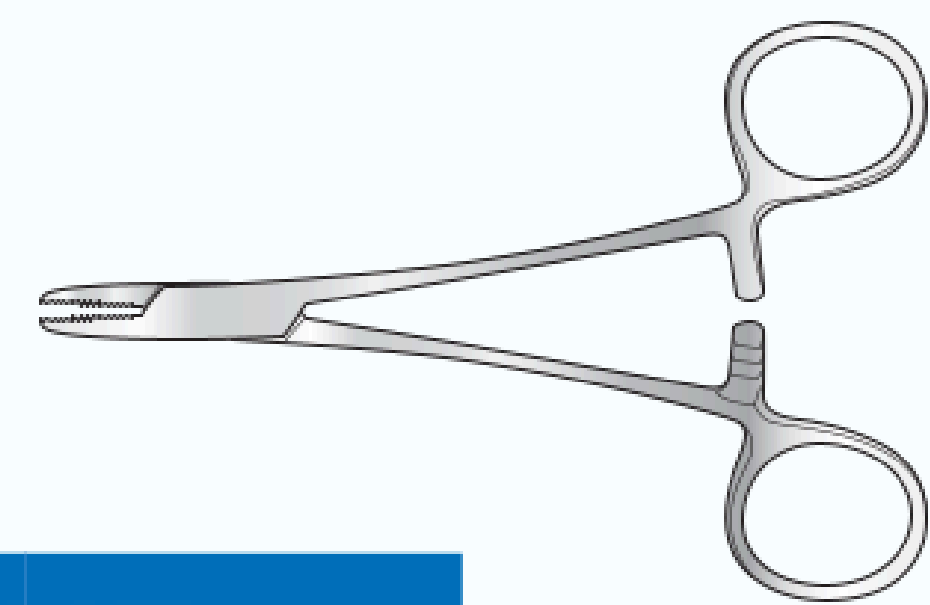

SC-GI/SH5924	140mm long
--------------	------------

Moynihan Artery Forceps

Box joint, half-serrated jaws

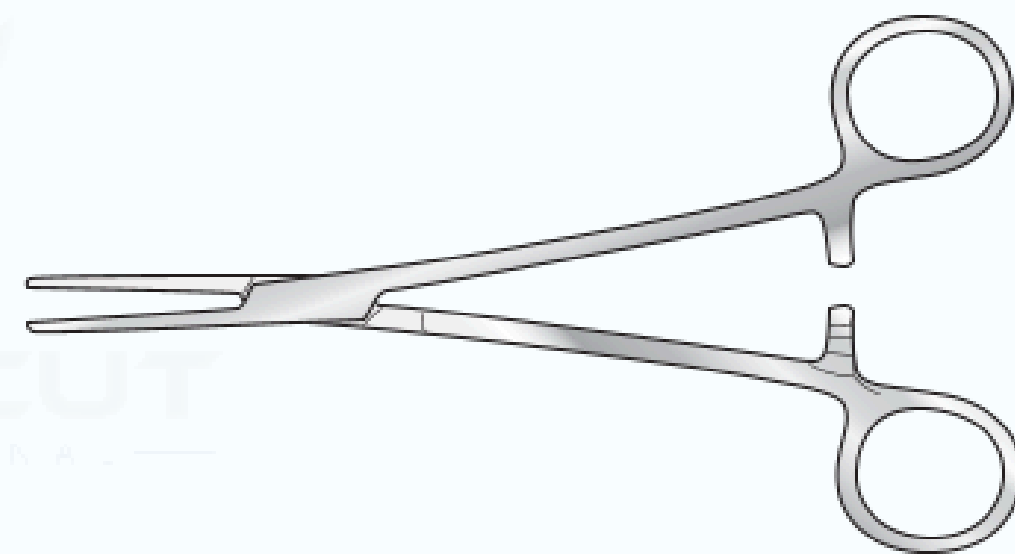

Straight		Curved	
SC-GI/018	145mm long	SC-GI/019	145mm long
SC-GI/068	180mm long	SC-GI/069	180mm long

Rochester-Pean Artery Forceps

Box joint

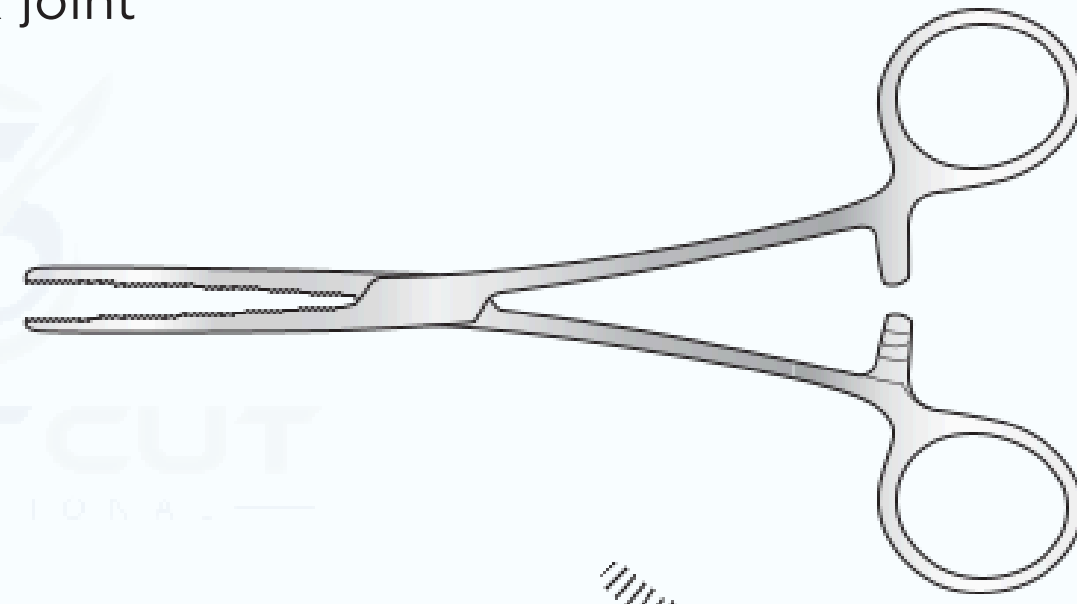

Straight		Curved	
-GI/044	165mm long	SC-GI/048	165mm long
SC-GI/045	190mm long	SC-GI/049	180mm long
SC-GI/046	205mm long	SC-GI/050	205mm long
SC-GI/047	240mm long	SC-GI/051	240mm long

Dieffenbach Bulldog Clamp

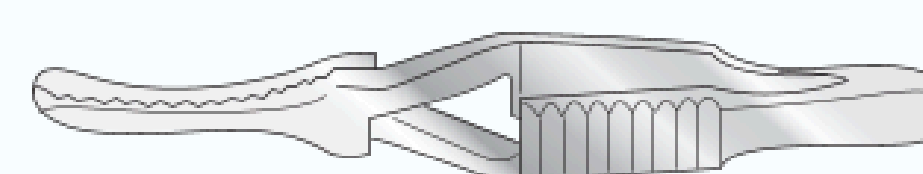
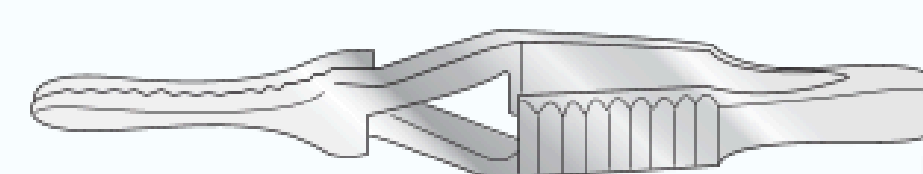

Straight, serrated		Straight, plain		Curved, serrated		Curved, plain	
SC-GI/112	1.2mm fine jaw, 40mm long	-GI/129	1.2mm fine jaw, 40mm long	-GI/119	1.2mm fine jaw, 40mm long	-GI/130	1.2mm fine jaw, 40mm long
SC-GI/113	1.2mm fine jaw, 45mm long	SC-GI/131	1.2mm fine jaw, 45mm long	SC-GI/120	1.2mm fine jaw, 45mm long	SC-GI/132	1.2mm fine jaw, 45mm long
SC-GI/108	1.8mm jaw, 30mm long	SC-GI/121	1.8mm jaw, 30mm long	SC-GI/115	1.8mm jaw, 30mm long	SC-GI/122	1.8mm jaw, 30mm long
SC-GI/109	1.8mm jaw, 35mm long	SC-GI/123	1.8mm jaw, 35mm long	SC-GI/116	1.8mm jaw, 35mm long	SC-GI/124	1.8mm jaw, 35mm long
SC-GI/110	2.5mm jaw, 40mm long	SC-GI/125	2.5mm jaw, 40mm long	SC-GI/117	2.5mm jaw, 40mm long	SC-GI/126	2.5mm jaw, 40mm long
SC-GI/111	2.5mm jaw, 45mm long	SC-GI/127	2.5mm jaw, 45mm long	SC-GI/118	2.5mm jaw, 45mm long	SC-GI/128	2.5mm jaw, 45mm long
SC-GI/107	6mm heavy jaw, 60mm long			SC-GI/114	6mm heavy jaw, 60mm long		
SC-GI/455	20mm jaw, 75mm long			SC-GI/456	20mm jaw, 75mm long		
SC-GI/455a	30mm jaw, 85mm long			SC-GI/456a	30mm jaw, 85mm long		
SC-GI/455b	45mm jaw, 105mm long			SC-GI/456b	45mm jaw, 105mm long		
SC-GI/455c	65mm jaw, 120mm long			SC-GI/456c	65mm jaw, 120mm long		

Roberts Artery Forceps

Screwjoint, curved on flat, serrated

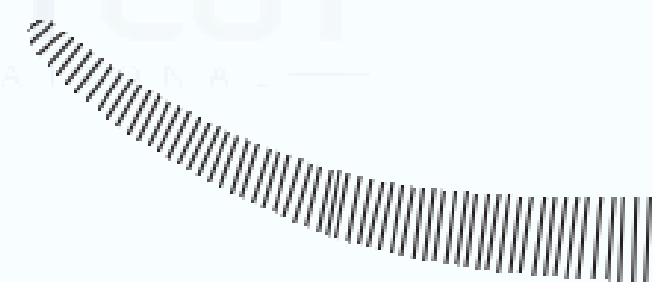
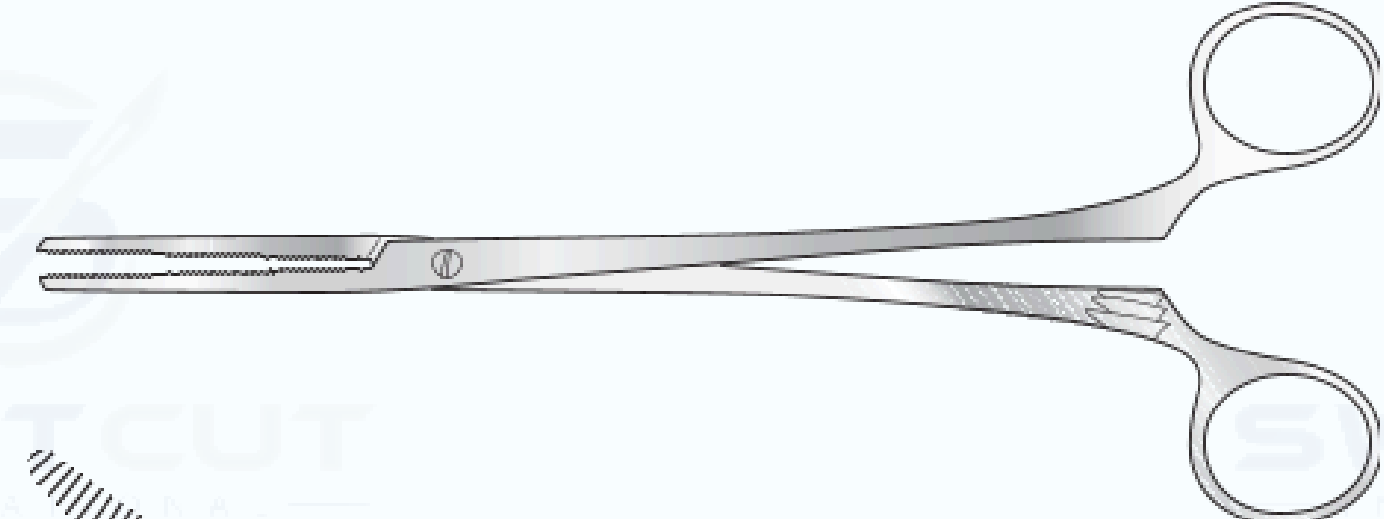

SC-GI/070	230mm long
-----------	------------

Spencer Wells Artery Forceps

Box joint, serrated jaws

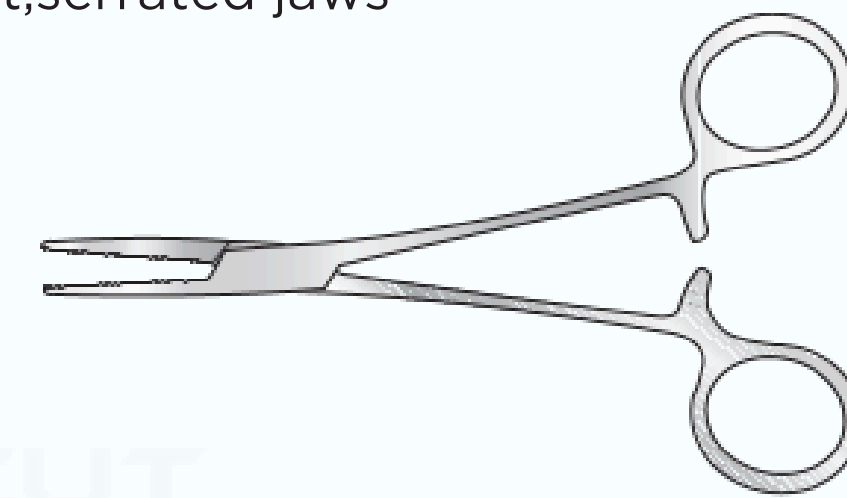

Straight		Curved	
-GI/035	127mm long	SCGI/039	127mm long
SC-GI/036	152mm long	SC-GI/040	152mm long
SC-GI/037	177mm long	SC-GI/041	177mm long
SC-GI/038	203mm long	SC-GI/042	203mm long

OTHER SIZES AVAILABLE

Blalock Bulldog Clamp

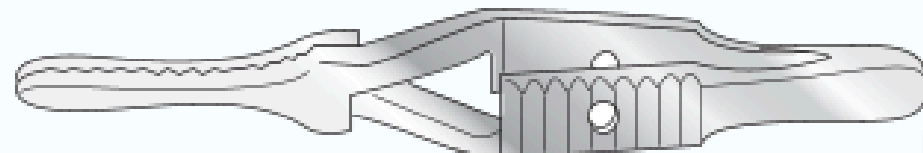

Serrated, with hole in handle

Straight		Curved	
SCGI/480	11mm jaw, 38mm long	SCGI/478	11mm jaw, 38mm long
SC-GI/482	14mm jaw, 48mm long	SC-GI/479	14mm jaw, 48mm long
SC-GI/493	17mm jaw, 60mm long	SC-GI/491	17mm jaw, 60mm long
SC-GI/481	27mm jaw, 70mm long	SC-GI/492	27mm jaw, 70mm long

Plain, with hole in handle

Straight		Curved	
SC-GI/486	11mm jaw, 38mm long	SC-GI/483	11mm jaw, 38mm long
SC-GI/487	14mm jaw, 48mm long	SC-GI/484	14mm jaw, 48mm long
SC-GI/488	17mm jaw, 60mm long	SC-GI/485	17mm jaw, 60mm long
SC-GI/489	27mm jaw, 70mm long	SC-GI/490	27mm jaw, 70mm long

Dandy Artery Forceps

Box joint, curved in plane

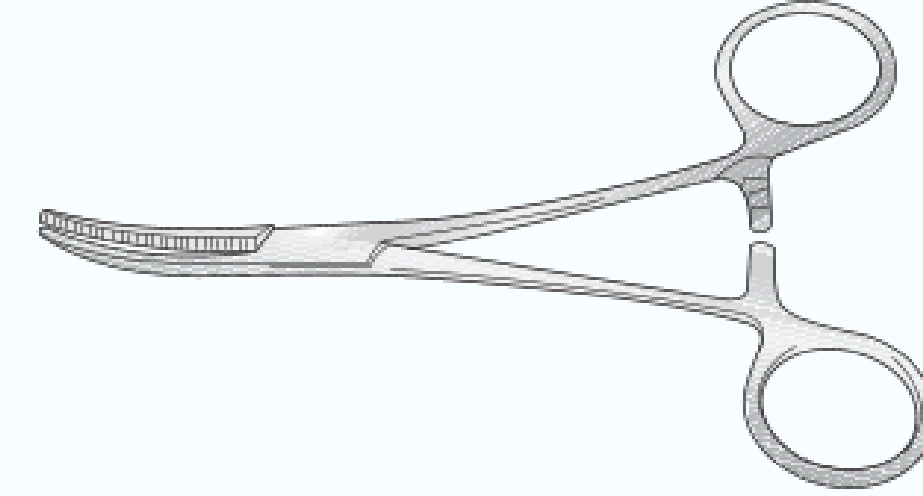

SC-GI/076	140mm long
-----------	------------

Carmalt Angiotribe Forceps

Box joint, atraumatic, light pattern

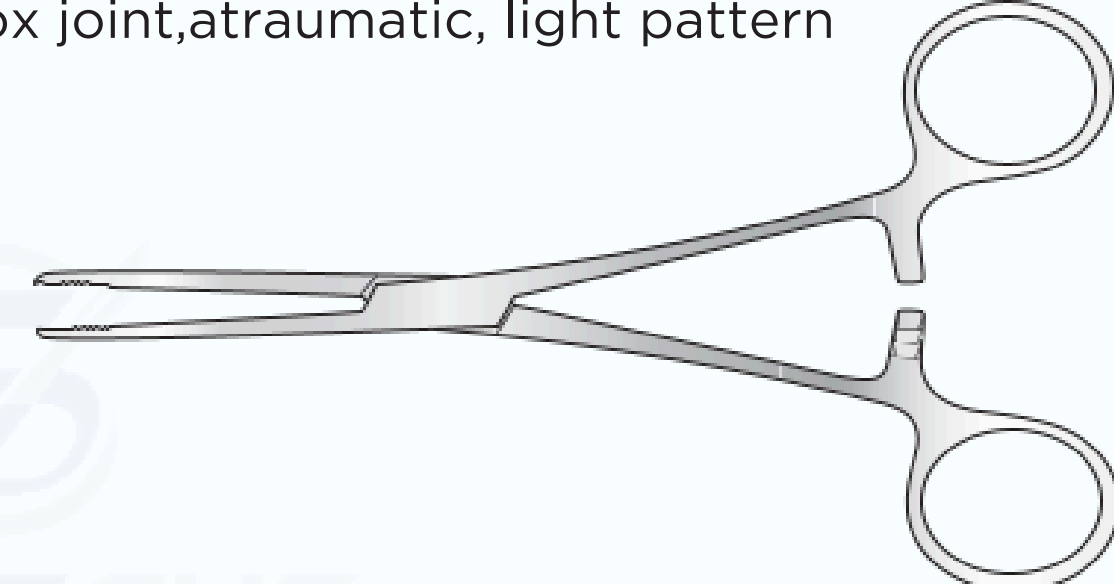

Straight		Curved	
SCGI/062	165mm long	SC-GI/061	165MM
SC-GI/063	200mm long		
SC-GI/064	230mm long		

Adsons Dissecting Forceps

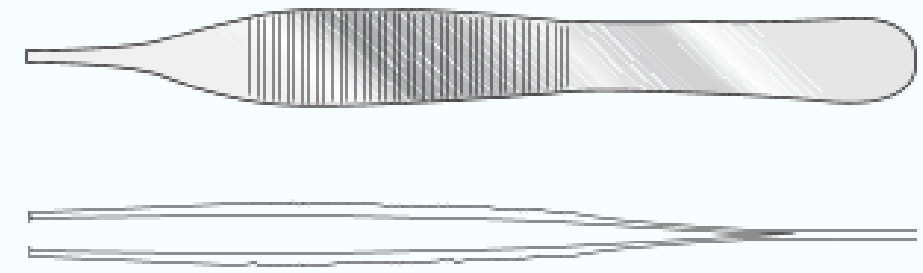

127mm long

SC-GI/257	1-2 teeth
SC-GI/258	Lightweight, micro
SC-GI/259	Serrated
SC-GI/260	Serrated, lightweight, micro

Block End Dissecting Forceps

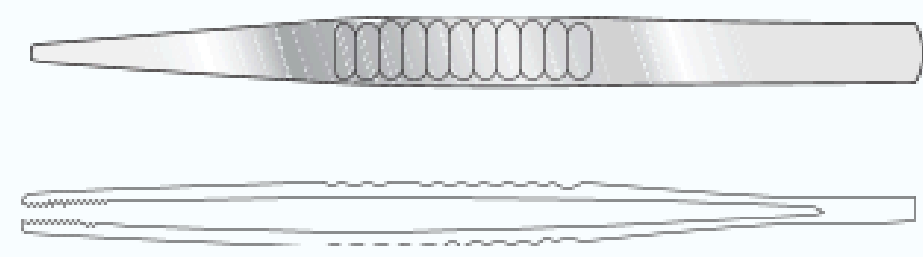

Serrated

SCGI/255	127mm long
SC-GI/256	152mm long
SC-GI/256a	203mm long

Bonney Dissecting Forceps

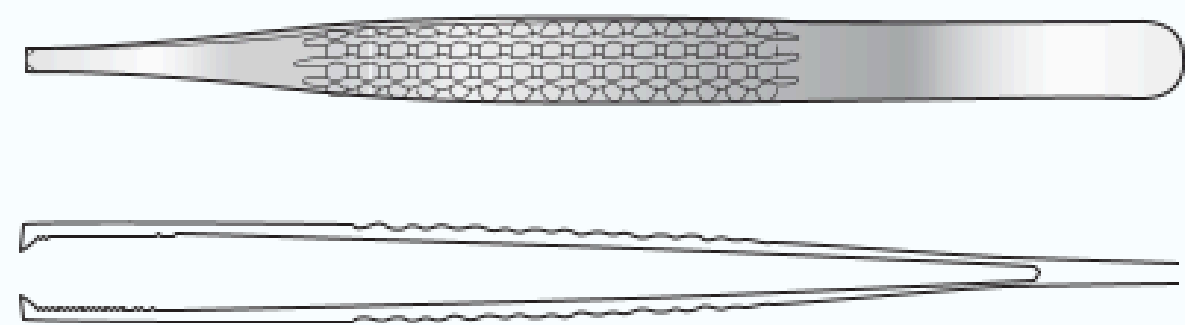

178mm long

SCGI/267	Serrated, 1-2 teeth
SC-GI/268	1-2 teeth

Charnley-McIndoe Dissecting Forceps

150mm long

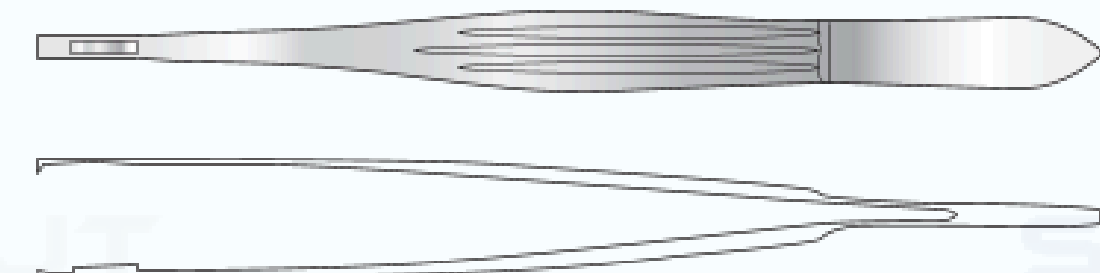

SC-OR/N045a	2-3 teeth
-------------	-----------

DeBakey Atraumatic Dissecting Forceps

Straight, atraumatic jaws

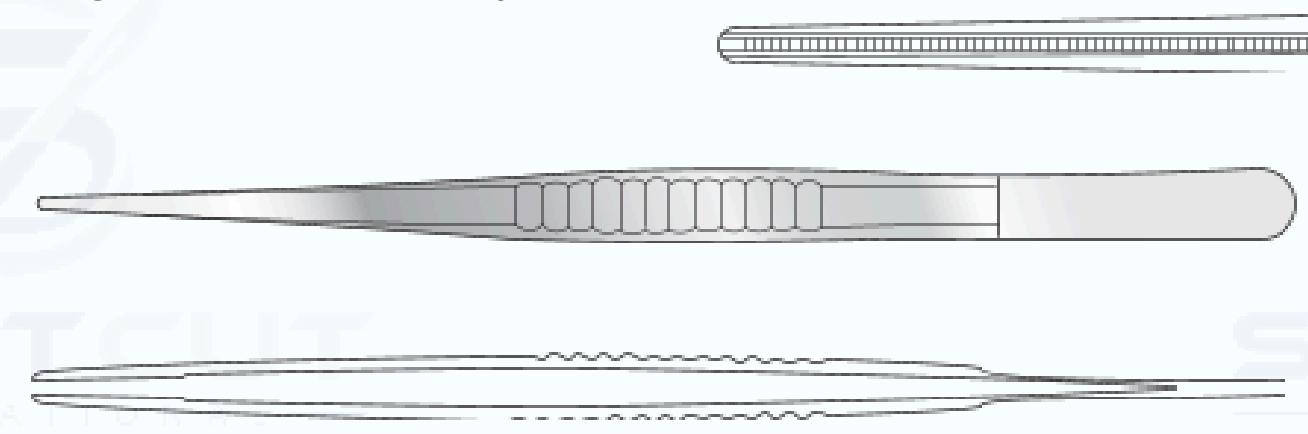

1.5mm

SCGI/238a	150mm long
SC-GI/240a	240mm long

2.5mm

SC-GI/238b	150mm long
SC-GI/240b	240mm long

2.8mm

GI/238	150mm long
SC-GI/241	180mm long

SC-GI/238c	150mm long
SC-GI/240c	240mm long
SC-GI/241c	180mm long

Dissecting Forceps

Turn over And, serrated jaws

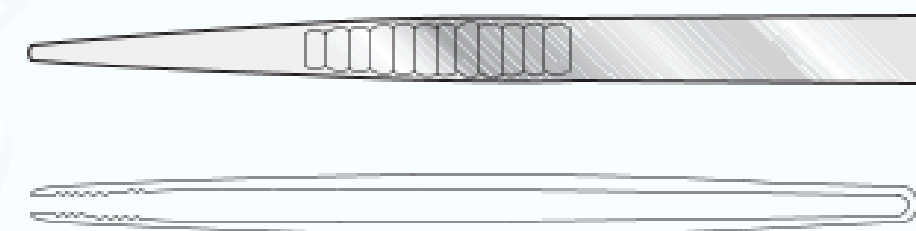

SC-GI/242	127mm long
SC-GI/243	152mm long

SC-GI/244	178mm long
SC-GI/245	203mm long

Dunhill Dissecting Forceps

Light, fine serrated jaws

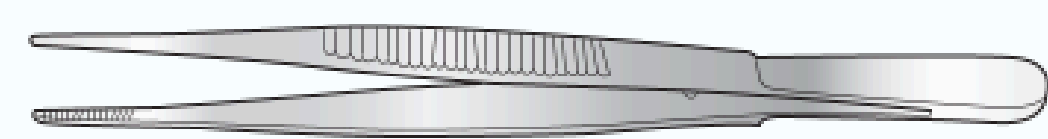

SC-GI/457	145mm long
-----------	------------

Fredrick Coole Dissecting Forceps

Extra fine serrated jaws

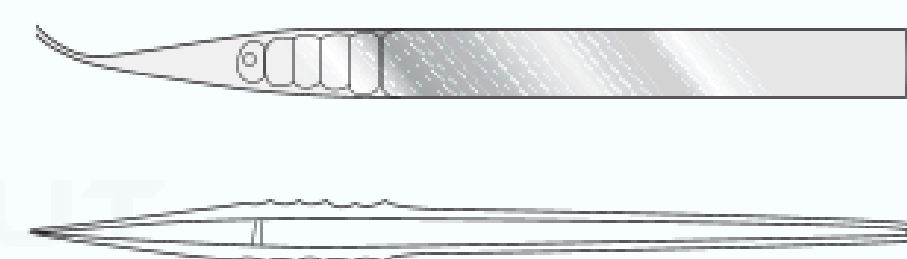

125mm long

SCGI/066	Straight
SC-GI/067	Curved

Gillies Dissecting Forceps

1-2 teeth

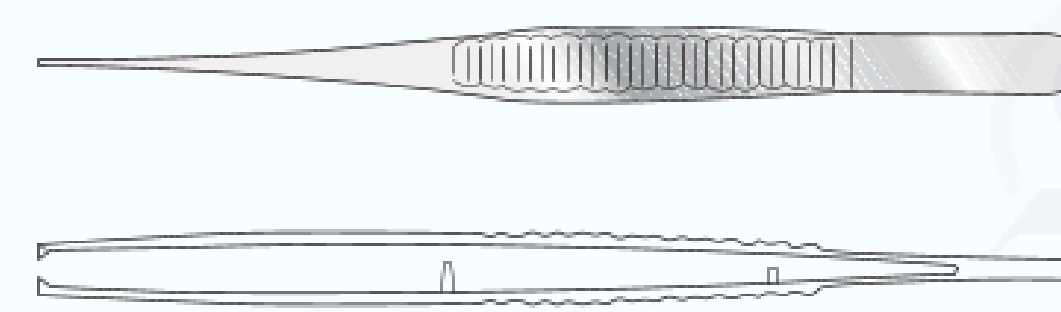

SC-PL/052	152mm long
-----------	------------

Jackson Burrows Dissecting Forceps

140mm long

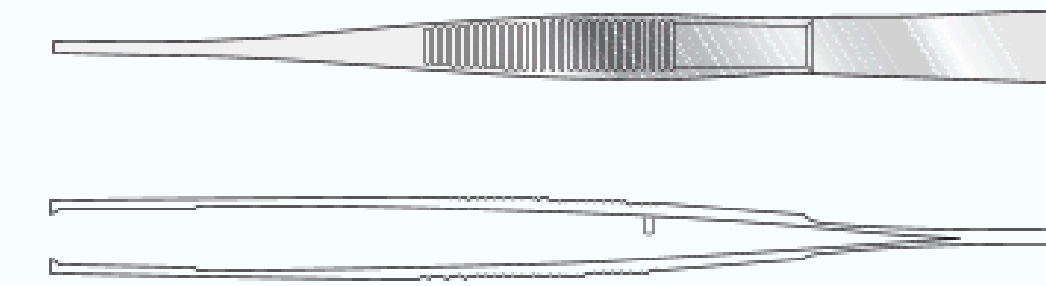

SC-OR/N037	Tongue and groove, 1-2 teeth
SC-OR/N037a	Tongue and groove only

Jean Dissecting Forceps

Serrated jaws, 140mm long

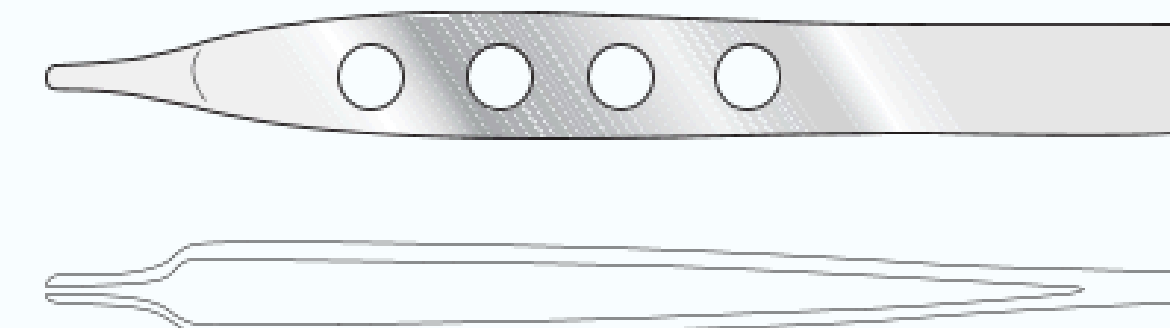

SCGI/269	Fine
SC-GI/270	1-2 teeth
SC-GI/271	2-3 teeth, 178mm long

Lanes Dissecting Forceps

1-2 teeth on serrated jaws, 140mm long

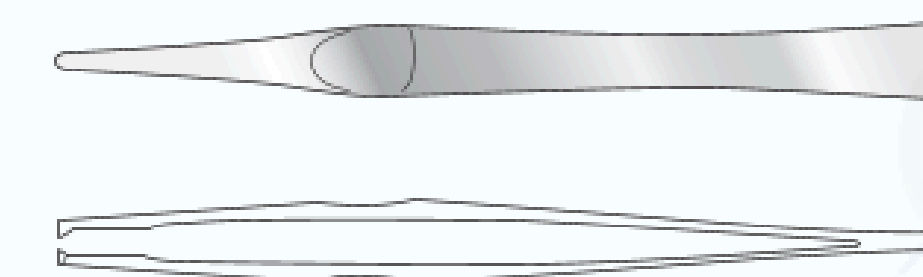

SC-GI/246	127mm long
SC-GI/247	152mm long
SC-GI/248	178mm long

SCGI/249	2-3 teeth, 178mm long
SC-GI/250	2-3 teeth 203mm long

McIndoe Dissecting Forceps

152mm long

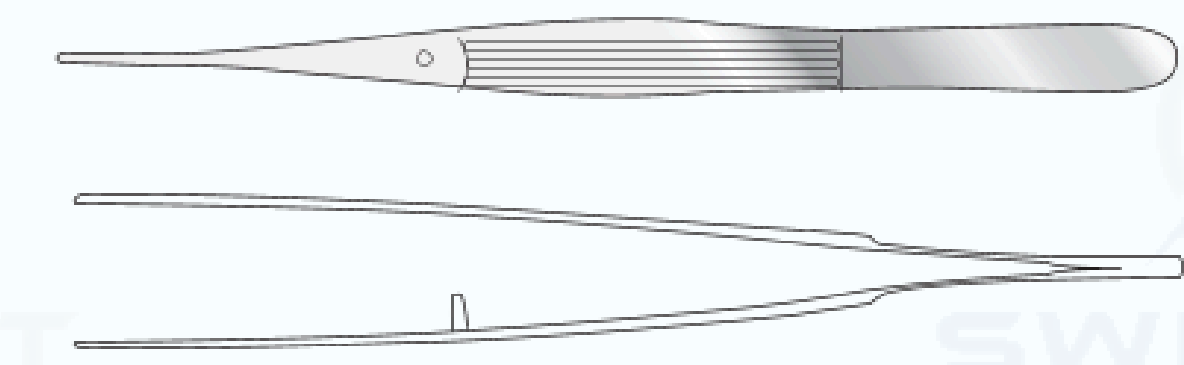

SCGI/476	Serrated
SC-GI/477	1-2 teeth

McIndoe Modified Dissecting Forceps

152mm long, 1mm tip, modified for fine powerful dissection with strong action tip

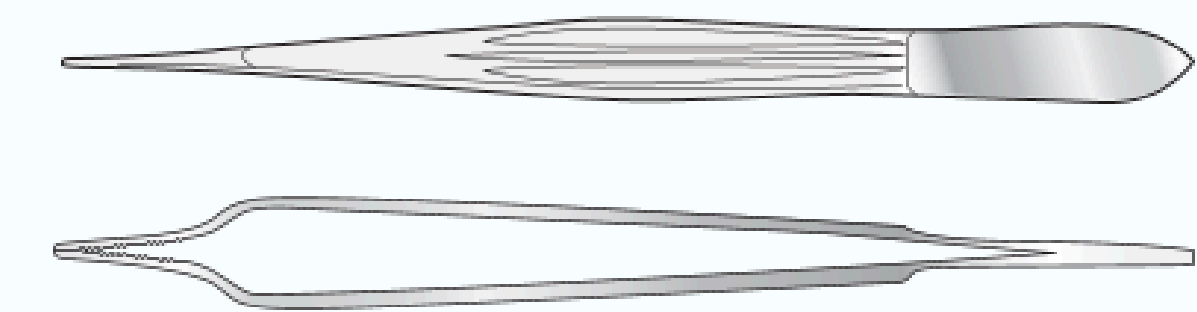

SH/5961	Serrated
---------	----------

Treves Dissecting Forceps

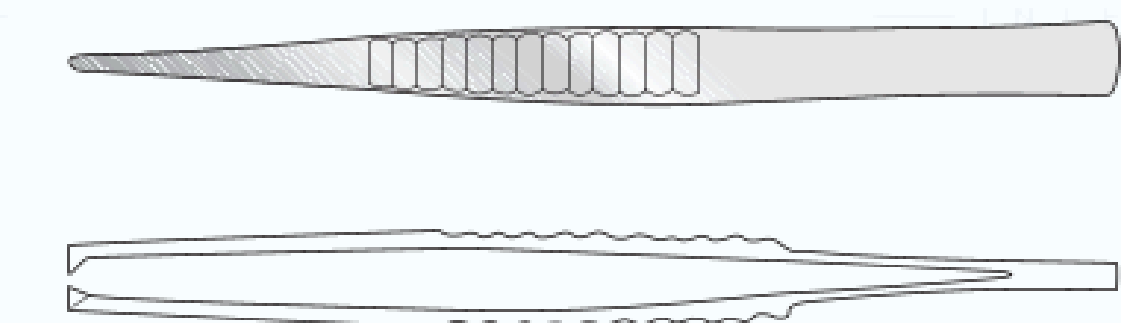

1-2 teeth

SC-GI/251	127mm long
SC-GI/252	152mm long

2-3 teeth

SCGI/253	127mm long
SC-GI/254	152mm long

Waugh Dissecting Forceps

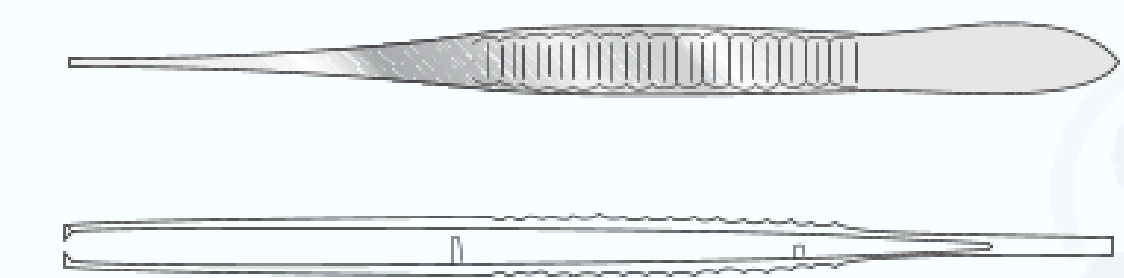

Fine, serrated

SC-GI/261	152mm long
SC-GI/262	178mm long
SC-GI/263	203mm long

Fine, 1-2 teeth

SCGI/264	152mm long
SC-GI/265	178mm long
SC-GI/266	203mm long

Allis Tissue Forceps

Box joint

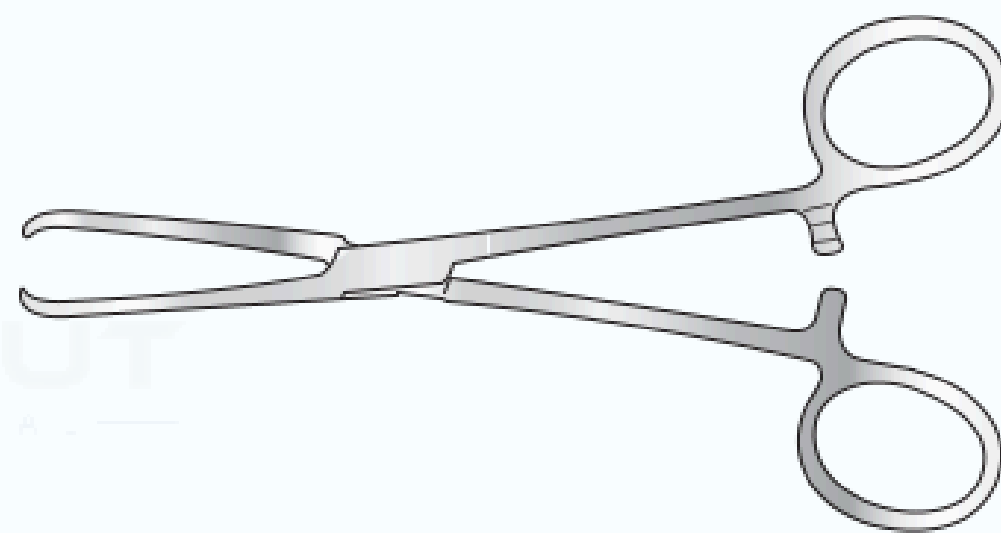

150mm long

SCGI/272	3-4 teeth
SC-GI/273	4-5 teeth

190mm long

SC-GI/414	5-6 teeth
-----------	-----------

Littlewood Tissue Forceps

Box joint, 2-3 teeth

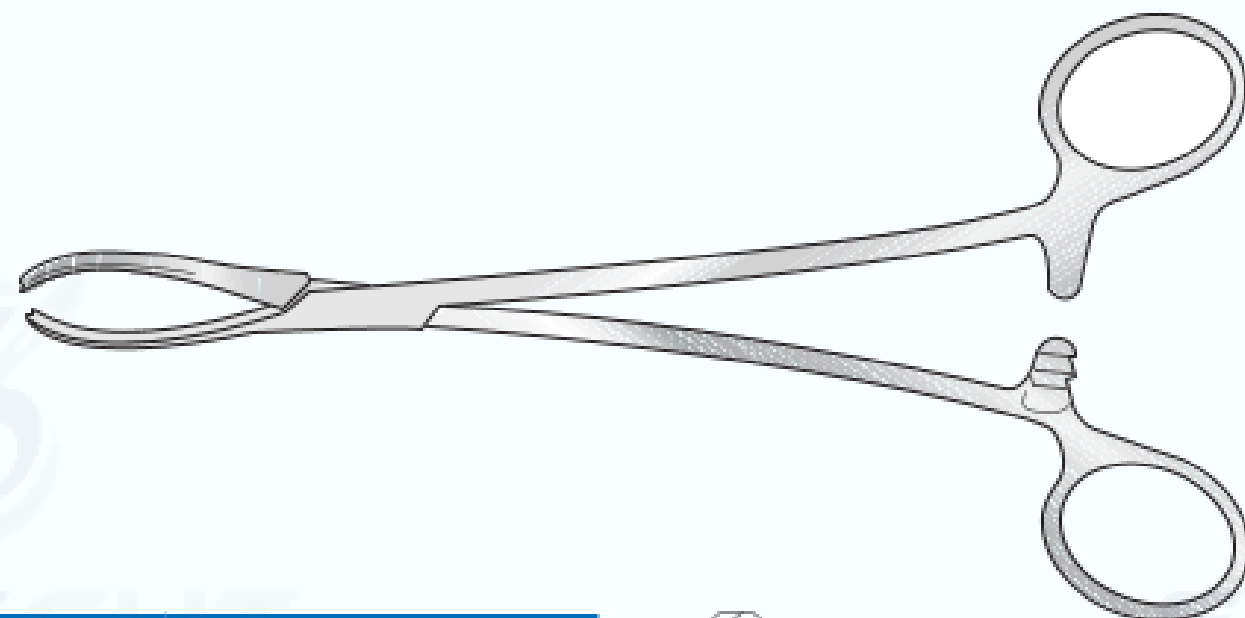

SC-GI/275	190mm long
-----------	------------

Babcock Tissue Forceps

Box joint, serrated jaws

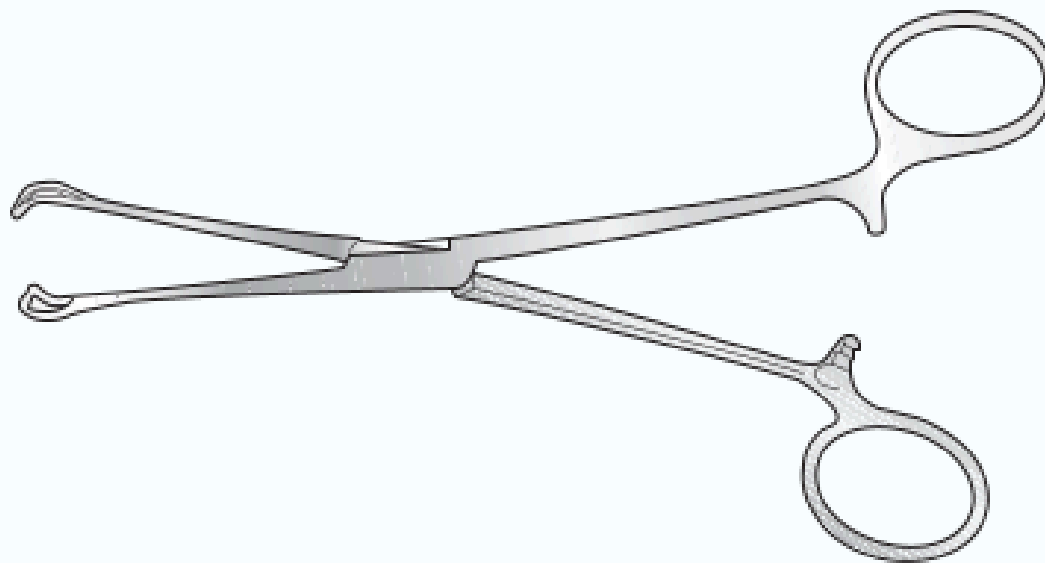

SCGI/276	160mm long
SC-GI/277	200mm long
SC-GI/278	230mm long

Duval Tissue Forceps

Box joint

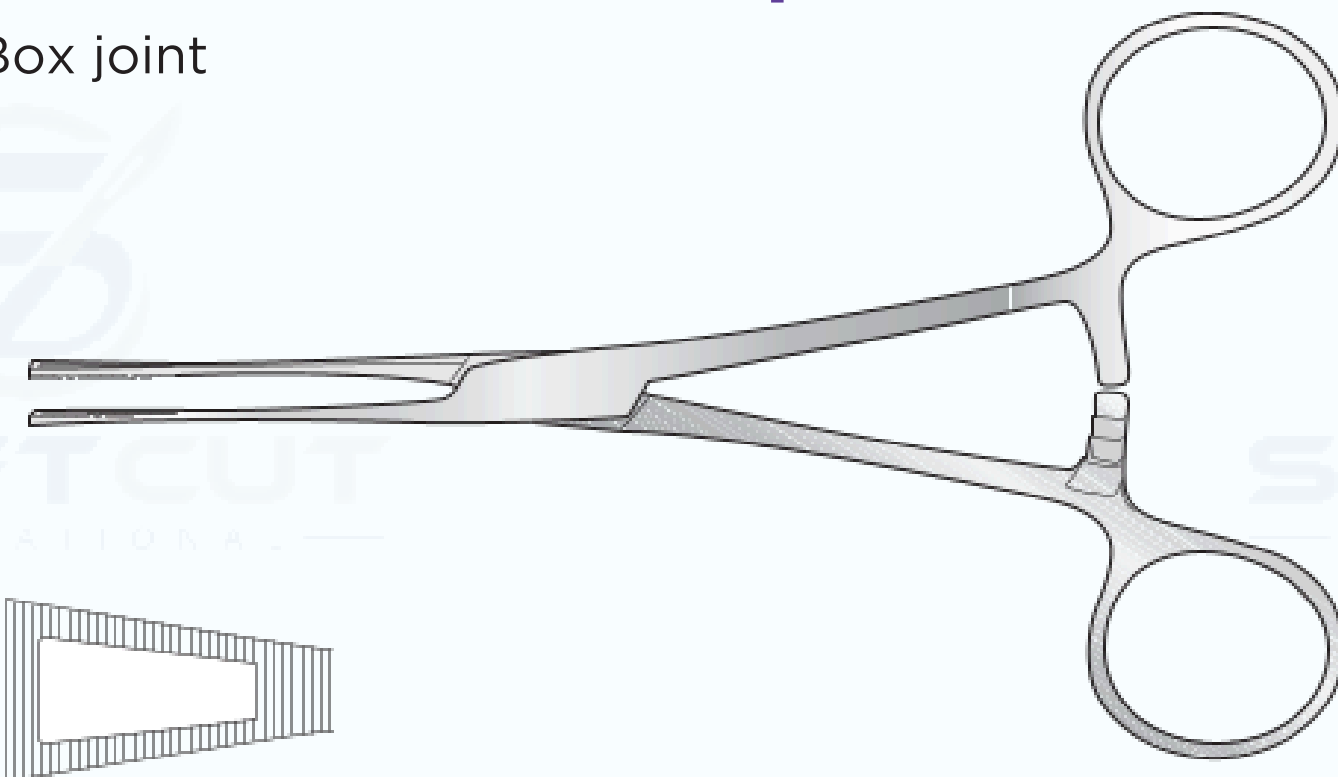

SC-GI/279	13mm wide, 203mm long
-----------	-----------------------

Lane Tissue Forceps

Box joint, 1-2 teeth, fenestrated

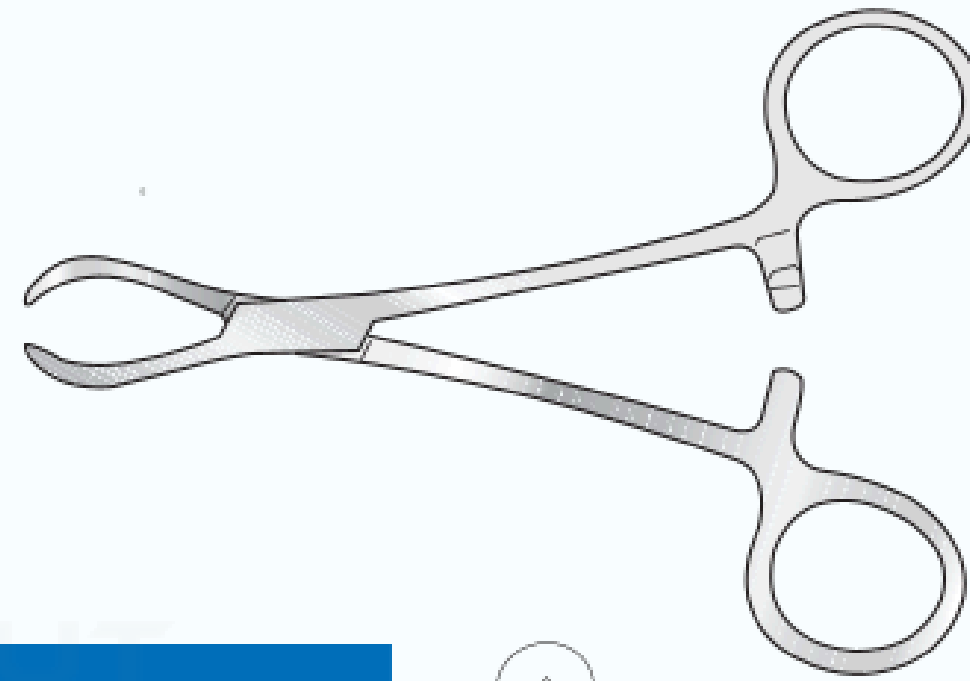

SC-GI/280	127mm long
SC-GI/281	152mm long
SC-GI/282	197mm long

Rutherford Morrison Tissue Forceps

Box joint

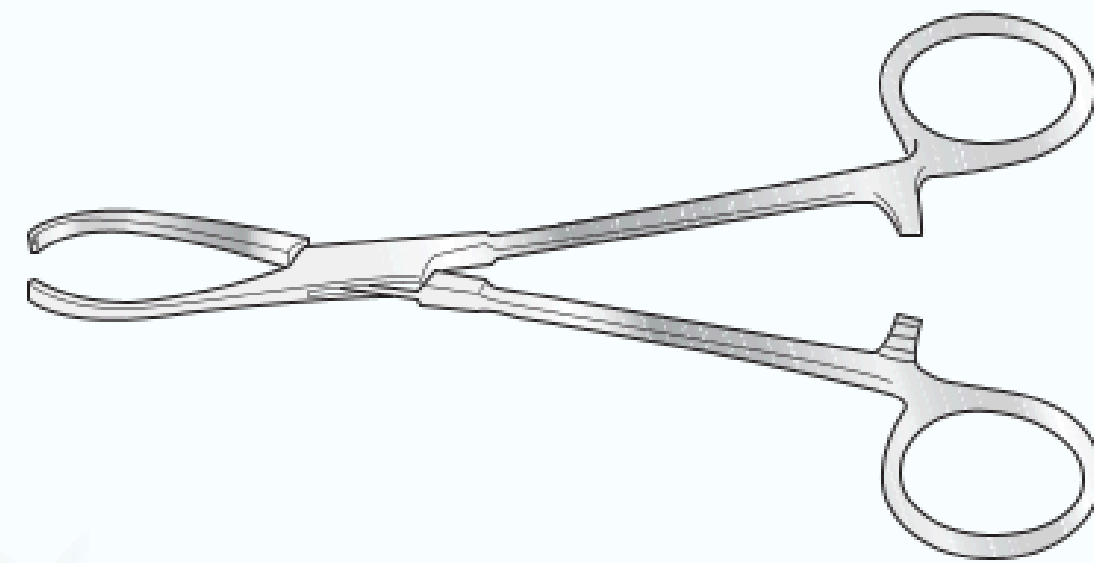

SC-GI/283	4-5 teeth, 152mm long
-----------	-----------------------

Shaw Tissue Forceps

Box joint

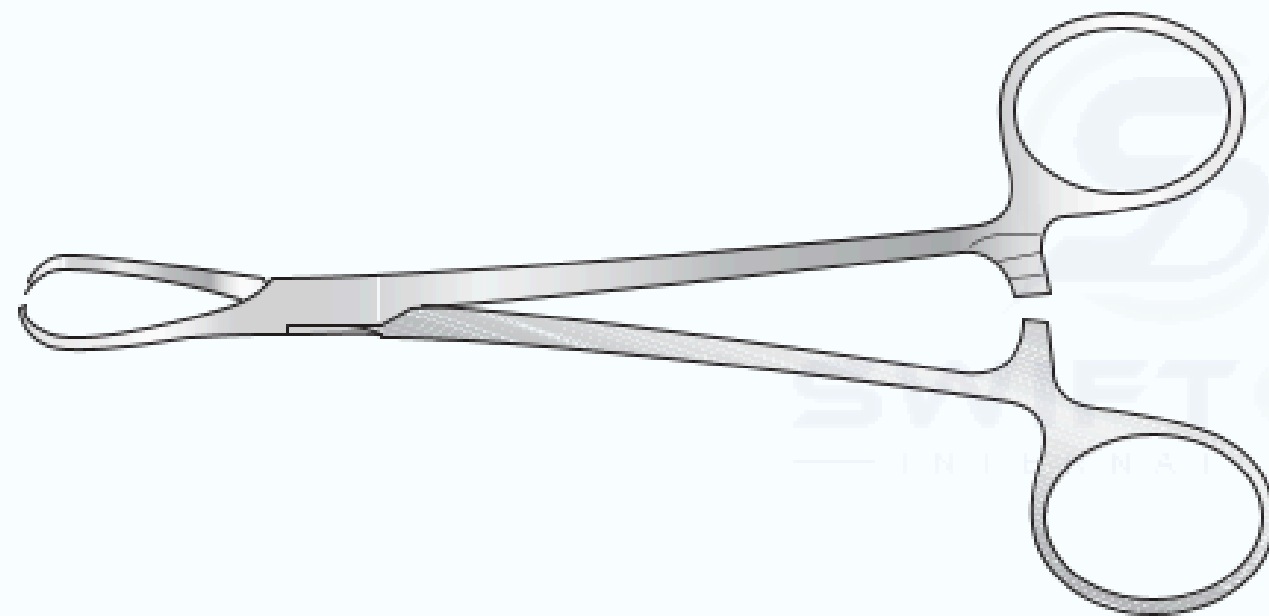

SC-GI/458	1-2 teeth, 178mm long
-----------	-----------------------

Guys Gallabin Suture-Holding Forceps

Screw joint, angled flat blades

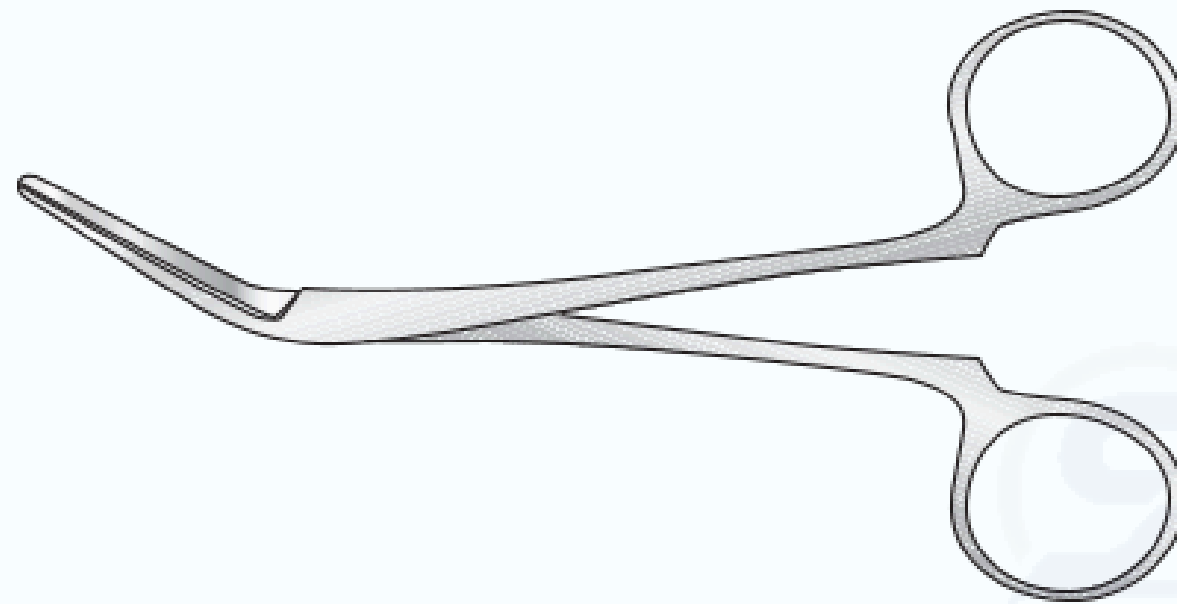

SC-GI/450	125mm long
SC-GI/4402	150mm long

Russian Dissecting Forceps

With fenestrated end

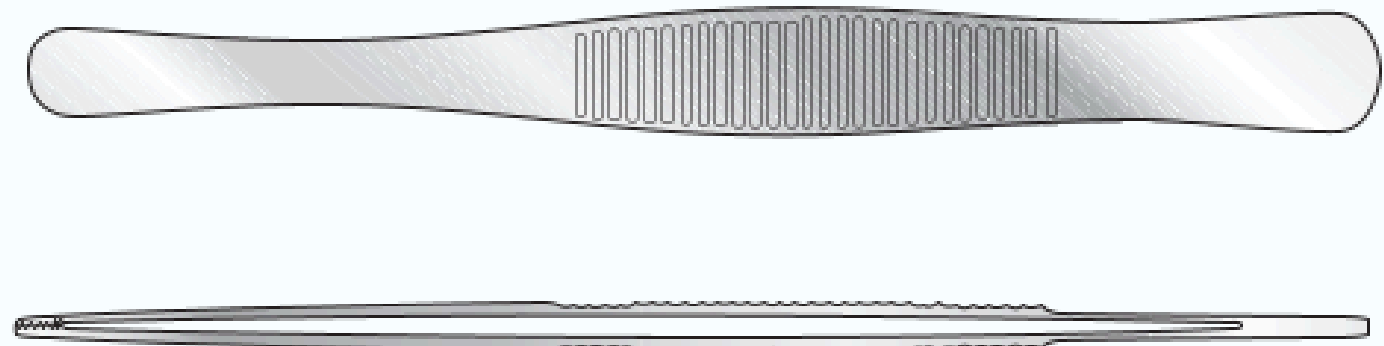

SC-GI/SH-5503b	150mm long
SC-GI/SH-5503	200mm long
SC-GI/403	230mm long
SC-GI/SH-5503a	250mm long

Rampley Sponge Holding Forceps

Box joint, straight, serrated jaws

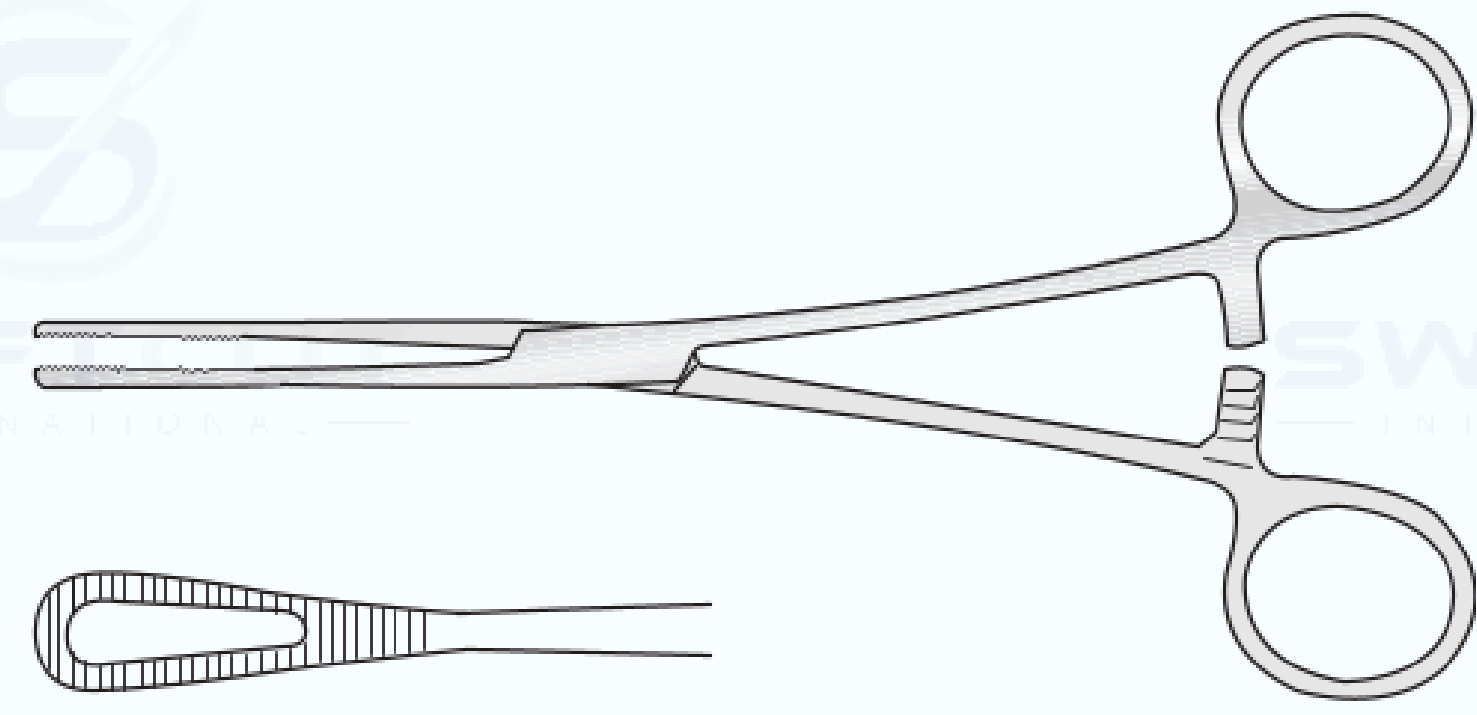

SCGI/353	178mm long
SC-GI/354	241mm long

Lister Sinus Forceps

Box joint, serrated tip

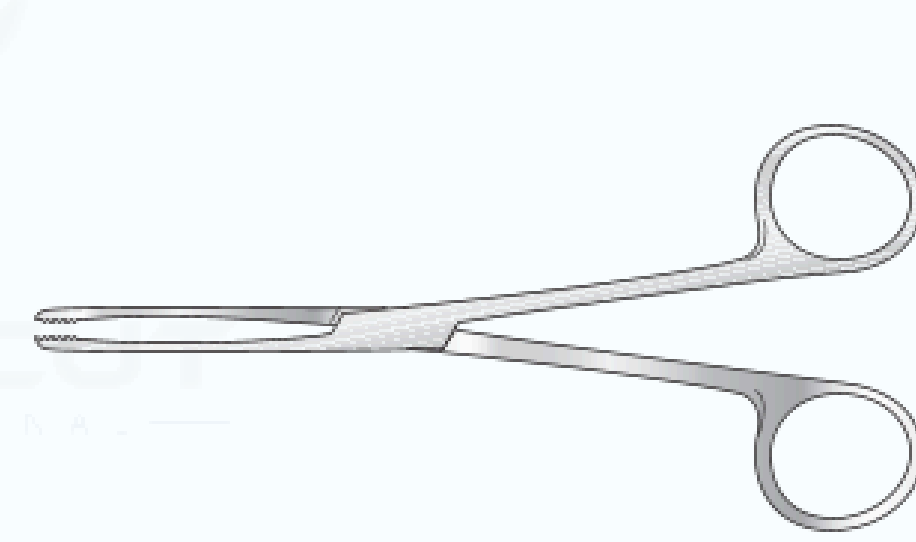

SCGI/367	127mm long
SC-GI/368	152mm long
SC-GI/369	178mm long

Foerster Sponge Holding Forceps

Box joint, straight, serrated jaws

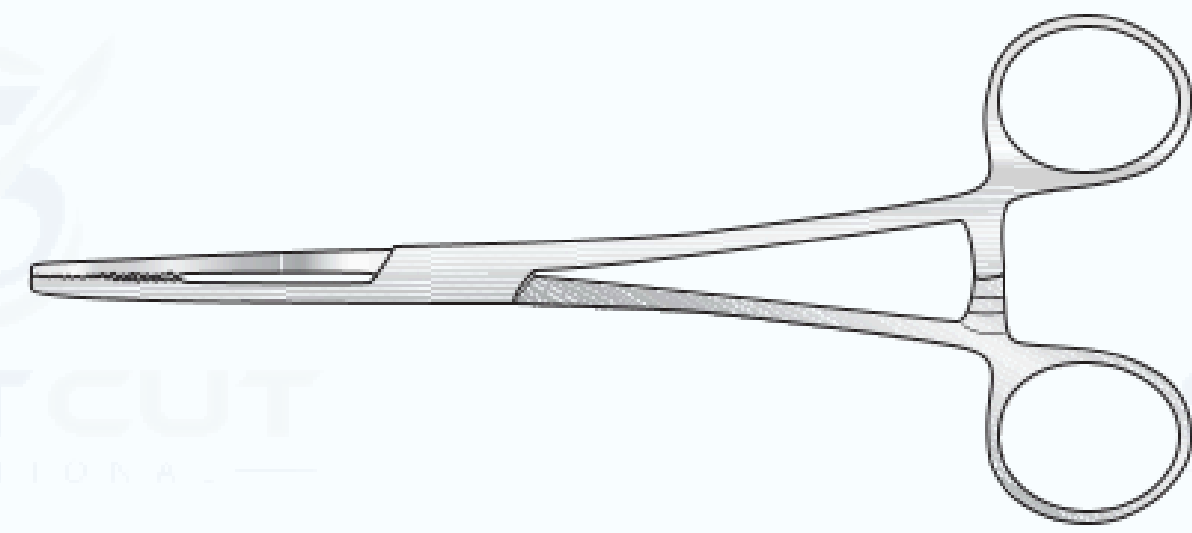

SC-GI/354a	178mm long
------------	------------

Cheate Sterilizer Forceps

Screw joint

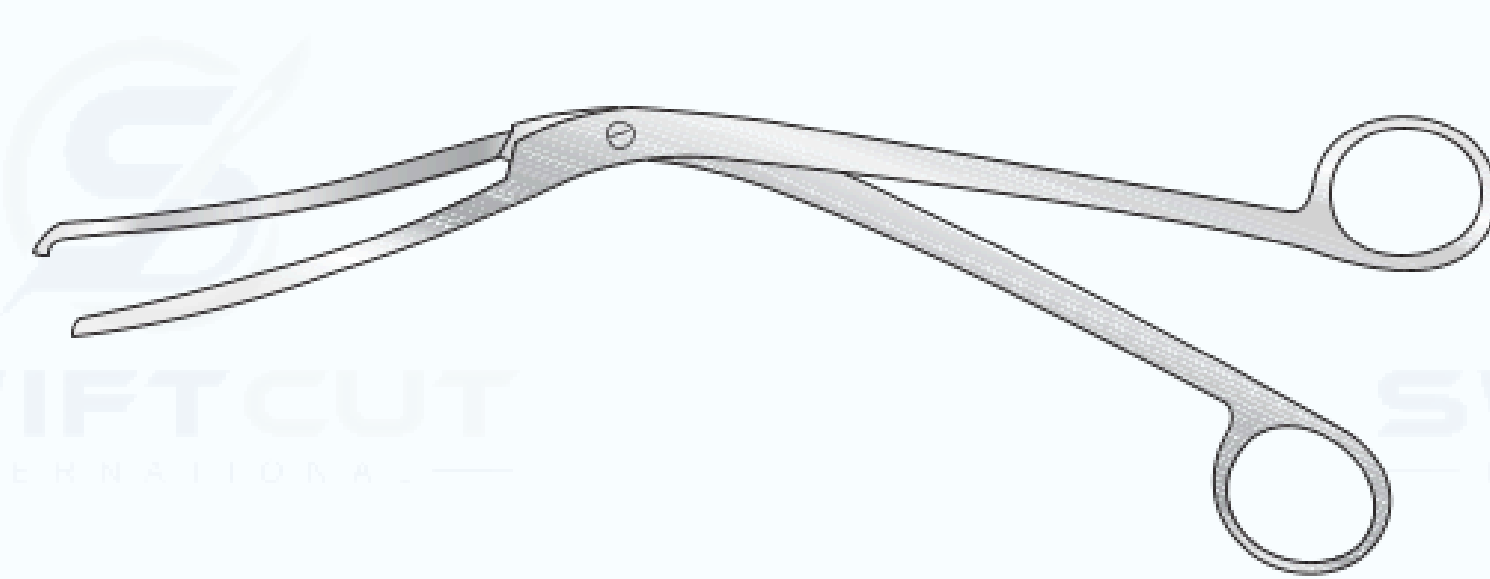

SC-GI/364	267mm long
-----------	------------

Harrison Bowl Steriliser Forceps

Screw joint, angled, double jaw

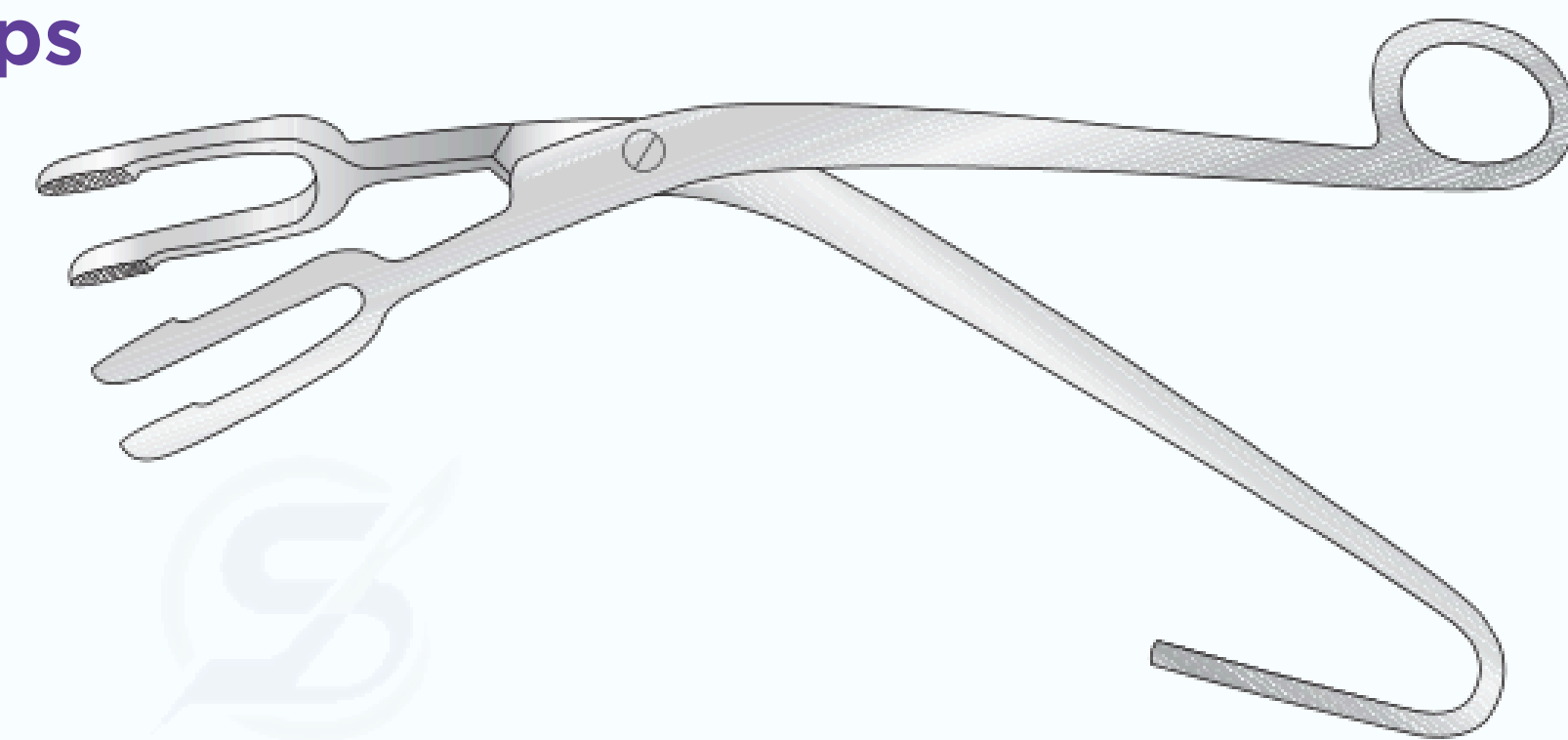

SCGI/365	356mm long
SC-GI/366	457mm long

Hunter Splinter Forceps

Serrated grooved pointed jaws

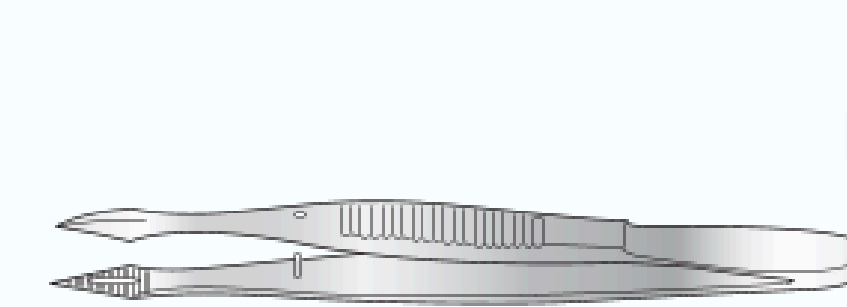

SC-GI/360	115mm long
-----------	------------

Michel Skin Holding Forceps

With magazine for Michel clips

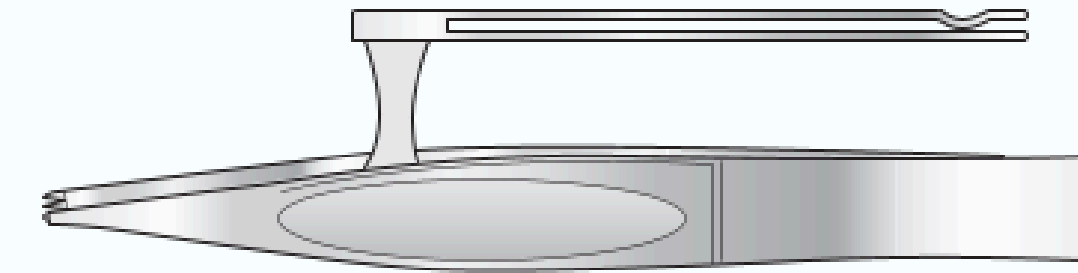

SC-GI/358	1-2 teeth, 127mm long
-----------	-----------------------

Childe Approximating Forceps

With magazine for Michel clips

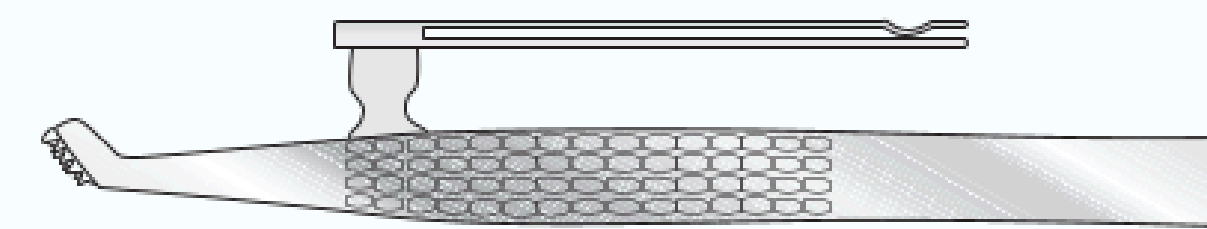

SC-GI/469	180mm long
-----------	------------

Michel Forceps

Box joint, double-ended, for inserting and removing clips stainless steel

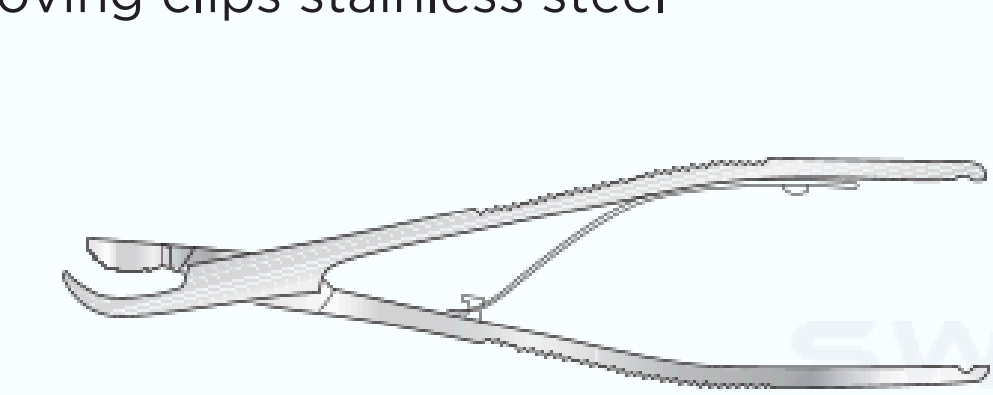

SC-GI/357	130mm long
-----------	------------

Michel Clip Extracting Forceps

Box joint

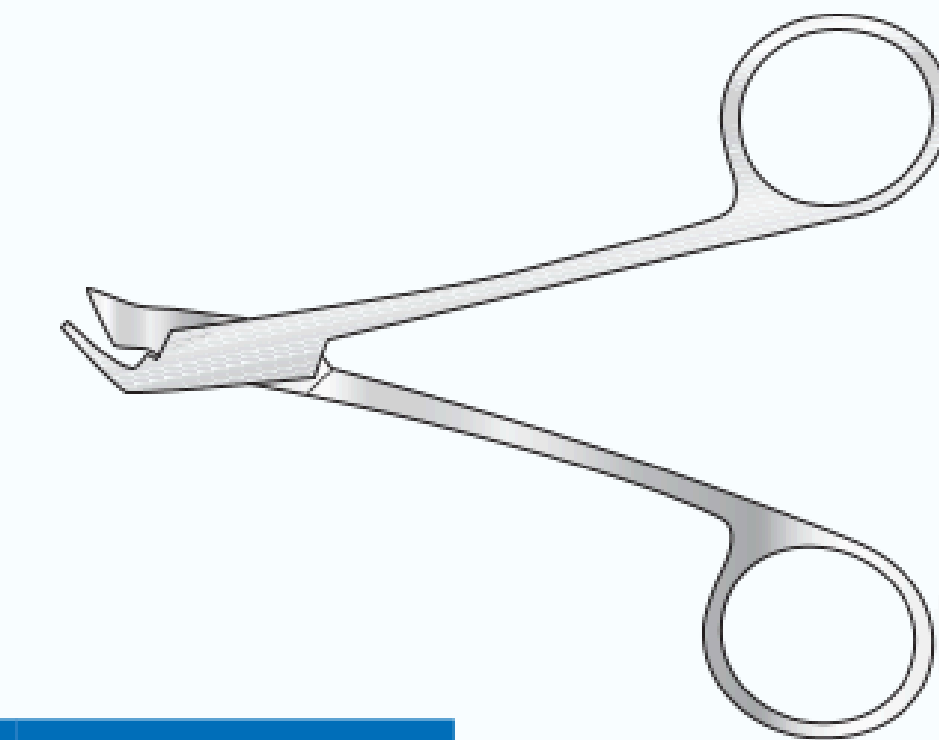

SC-GI/359	125mm long
-----------	------------

Robins Anchoring Forceps

140 mm long

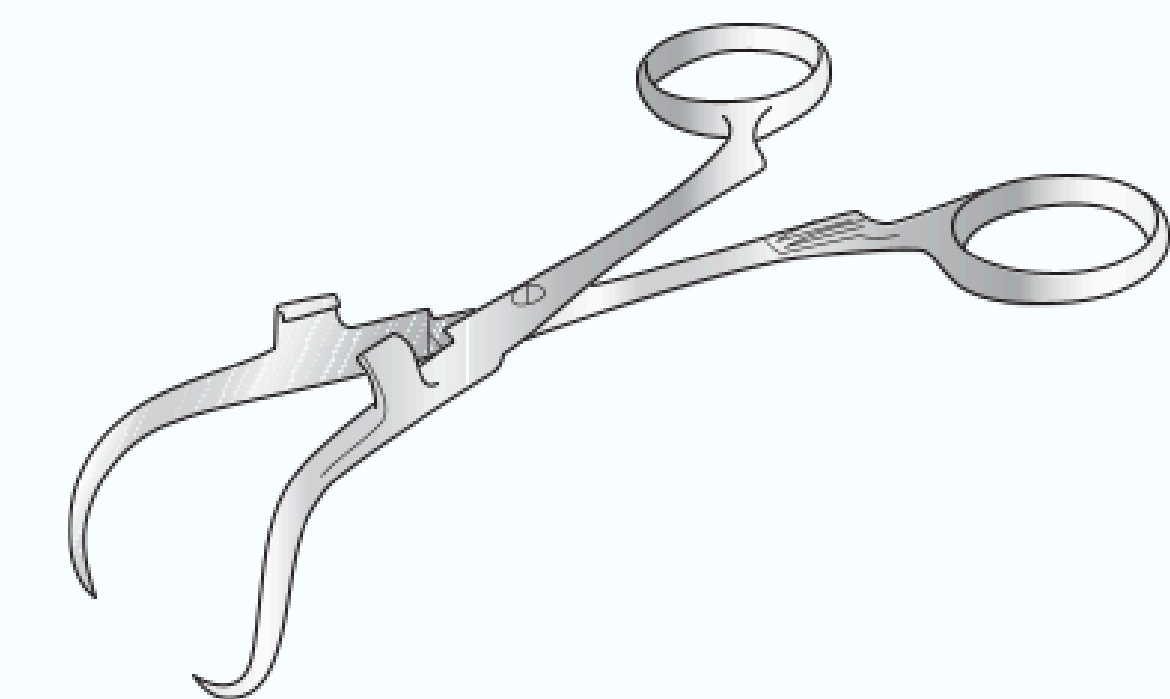

SC-GI/453	5mm with holder for diathermy leads
SC-GI/453a	13mm with holder for suction tubing

Dressing Scissors

Blunt/Blunt Straight

SC-GI/133	130mm long
SC-GI/136	146mm long
SC-GI/139	165mm long

Curved

SC-GI/142	130mm long
SC-GI/143	146mm long
SC-GI/144	165mm long
SC-GI/145	185mm long
SC-GI/404	147mm long

With one serrated blade

Blunt/Sharp Straight

SC-GI/134	130mm long
SC-GI/137	146mm long
SC-GI/140	165mm long

Sharp/Sharp Straight

SCGI/135	130mm long
SC-GI/138	146mm long
SC-GI/141	165mm long

Curved

SC-GI/146	130mm long
-----------	------------

Dressing Scissors, Left-Handed

With one black bow, 145mm long

Blunt/Blunt

SCGI/192	Straight
SC-GI/193	Curved

Blunt/Sharp

SCGI/194	Straight
SC-GI/195	Curved

Sharp/Sharp

SCGI/196	Straight
SC-GI/197	Curved

Little Dissecting Scissors

Fine pattern, with eye for suture

SC-PL/001F	115mm long
------------	------------

Kilner Dissecting Scissors

Fine pattern

SC-PL/001a	115mm long
------------	------------

Metzenbaum Scissors

Straight

SCGI/405	180mm long
SC-GI/406	147mm long
SC-GI/406a	200mm long
SC-GI/406b	230mm long
SC-GI/406c	250mm long
SC-GI/406d	280mm long

Curved

SC-GI/407	185mm long
SC-GI/408	147mm long
SC-GI/408a	200mm long
SC-GI/408b	230mm long
SC-GI/408c	250mm long
SC-GI/408d	280mm long

Mayo Scissors

Straight

SCGI/409	140mm long
SC-GI/409a	160mm long
SC-GI/411	190mm long
SC-GI/411a	230mm long

Curved

SC-GI/410	140mm long
SC-GI/410a	160mm long
SC-GI/412	190mm long
SC-GI/412a	230mm long

Fergusson Scissors

Angled on flat

SC-GI/148	180mm long
-----------	------------

Paynes Suture Scissors

SC-GI/152	100mm long
-----------	------------

Ligature Stitch Scissors

Fine pattern

SC-GI/153	115mm long
-----------	------------

Lister Bandage Scissors

SCGI/154	147mm long
SC-GI/155	178mm long

McIndoe Scissors

178 mm long

SCGI/149	Straight
SC-GI/150	Curved on flat
SC-GI/150sc	Supercut, curved

Heath Stitch Scissors

SC-GI/151	152mm long
-----------	------------

Tubing Scissors

SC-GI/147	130mm long
-----------	------------

Lister Bandage Scissors

Angled, with probe end

SC-GI/361	147mm long
SC-GI/362	178mm long

Thomas Strabismus Scissors

114 mm long

SCOP/030	Straight
SC-OP/029	Curved

“Careless” Scissors

SC-GI/474	165mm long
-----------	------------

Utility Scissors

SC-GI/466	190mm long
-----------	------------

Dressing Scissors

Tungsten carbide hard insert /blunt

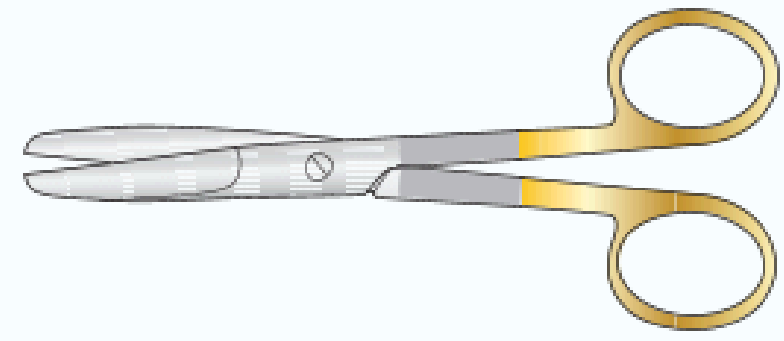

Straight

SC-GI/430	130mm long
SC-GI/432	145mm long
SC-GI/434	165mm long
SC-GI/436	185mm long

Curved

SCGI/431	130mm long
SC-GI/433	145mm long
SC-GI/435	165mm long

Dressing Scissors

Tungsten carbide hard insert, blunt/sharp

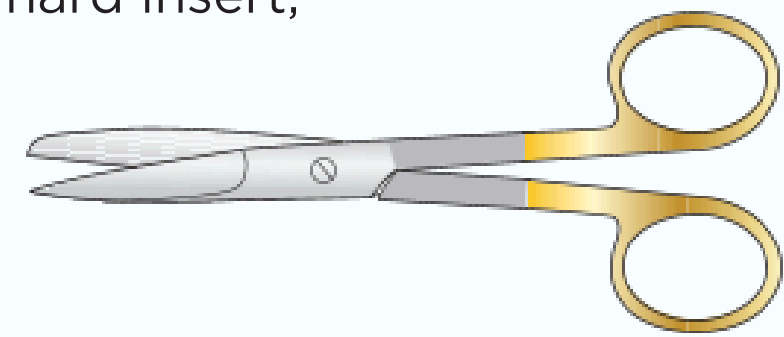

Straight

SCGI/423	130mm long
SC-GI/425	145mm long
SC-GI/427	165mm long
SC-GI/429	185mm long

Curved

SC-GI/424	130mm long
SC-GI/426	145mm long
SC-GI/428	165mm long

Dressing Scissors

Tungsten carbide hard inserts/sharp

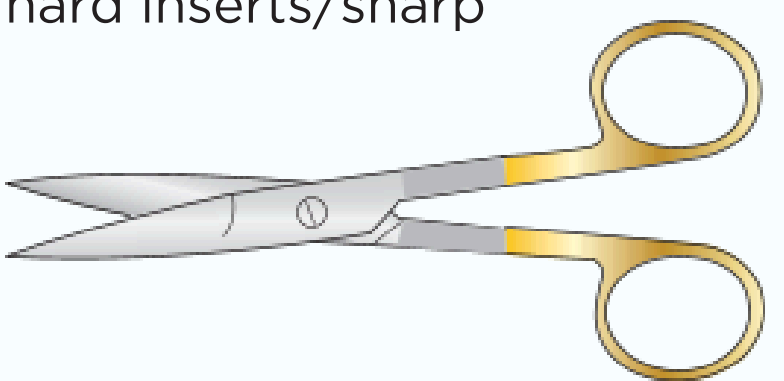

Straight

SC-GI/437	130mm long
SC-GI/439	145mm long
SC-GI/441	165mm long
SC-GI/443	185mm long

Curved

SC-GI/438	130mm long
SC-GI/440	145mm long
SC-GI/442	165mm long

Baby Metzenbaum Scissors

Tungsten carbide, hard insert, 145mm long

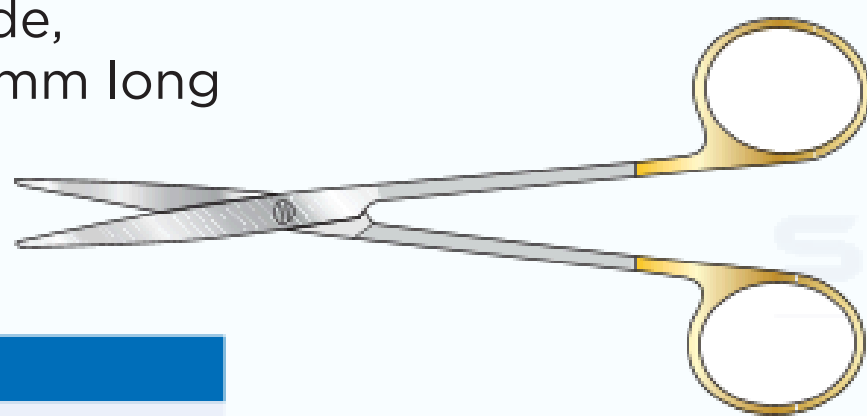

SCGI/445a	Straight
SC-GI/446a	Curved

Mayo Dressing Scissors

Tungsten carbide hard insert

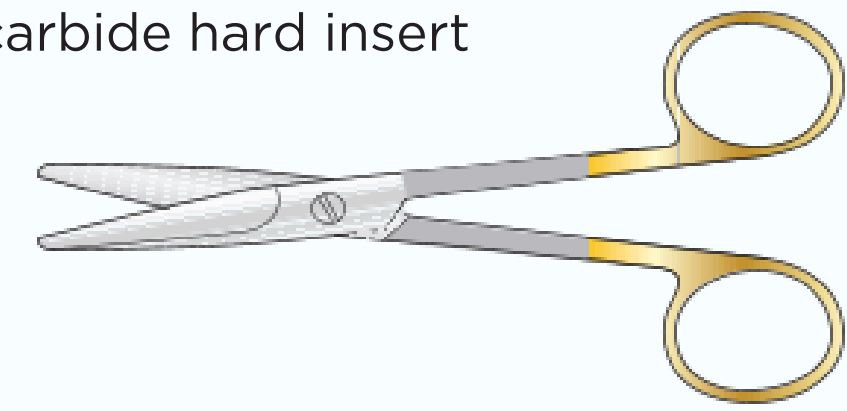

Straight

SC-GI/419	140mm long
SC-GI/419a	160mm long
SC-GI/421	190mm long
SC-GI/421a	230mm long

Curved

SC-GI/420	140mm long
SC-GI/420a	160mm long
SC-GI/422	190mm long
SC-GI/422a	230mm long

Mayo-Harrington Dressing Scissors

Tungsten carbide hard insert

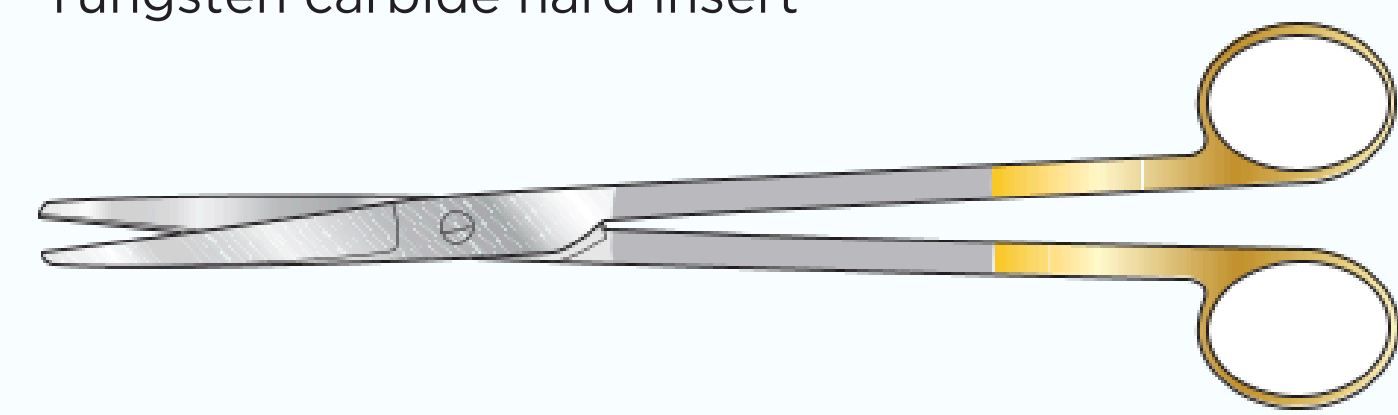

230mm long

SCGI/417	Straight
SC-GI/418	Curved

200mm long

SC-GI/162a	Straight
SC-GI/413b	Curved

Metzenbaum Scissors

Tungsten carbide hard insert

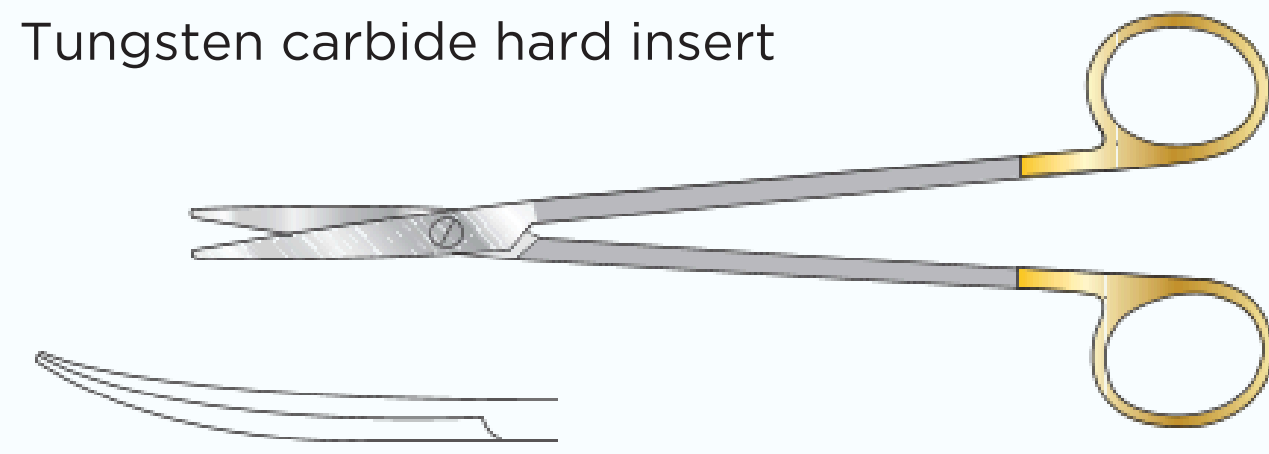

230mm long

SC-GI/445	145mm long
SC-GI/448	185mm long
SC-GI/471a	230mm long
SC-GI/471b	250mm long
SC-GI/471c	280mm long

200mm long

SC-GI/446	145mm long
SC-GI/449	185mm long
SC-GI/449a	200mm long
SC-GI/449b	230mm long
SC-GI/449c	250mm long
SC-GI/449d	280mm long

Ligature Scissors

Tungsten carbide hard insert, curved

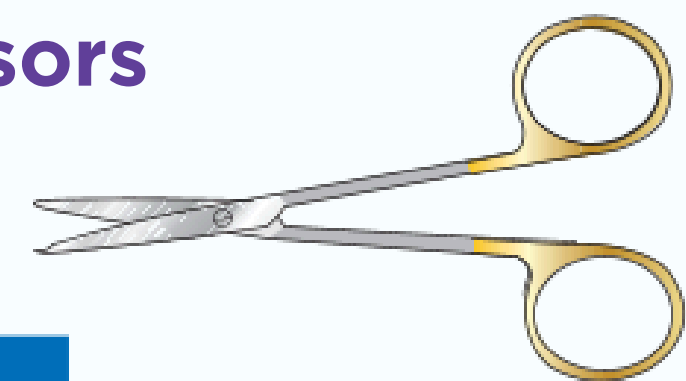

SC-GI/444	145mm long
SC-GI/447	185mm long

Mayo Harrington Scissors

Supercut, tungsten carbide

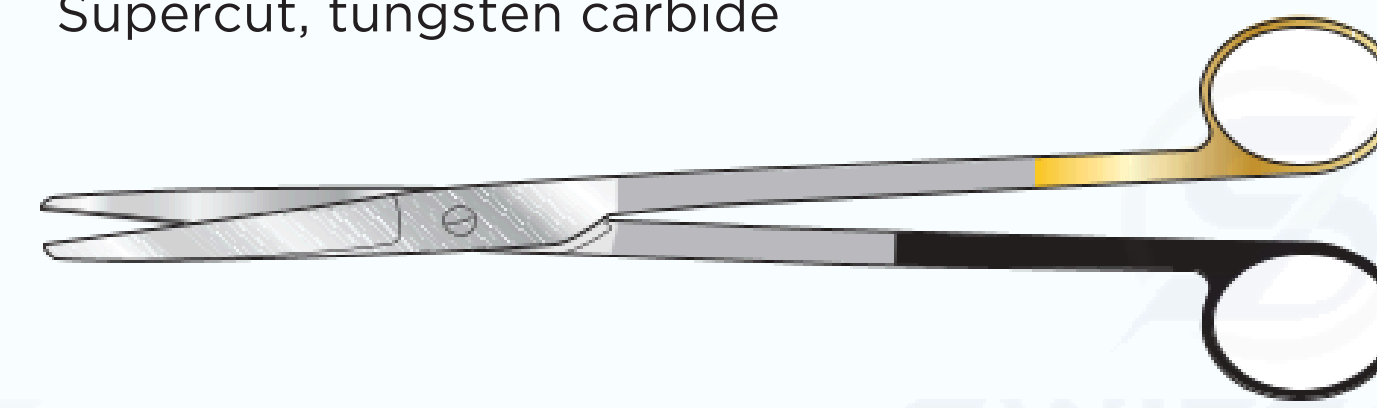

230mm long

SC-GI/162	Straight
SC-GI/413	Curved

200mm long

SC-GI/162b	Straight
SC-GI/413b	Curved

Mayo Scissors

Supercut, tungsten carbide

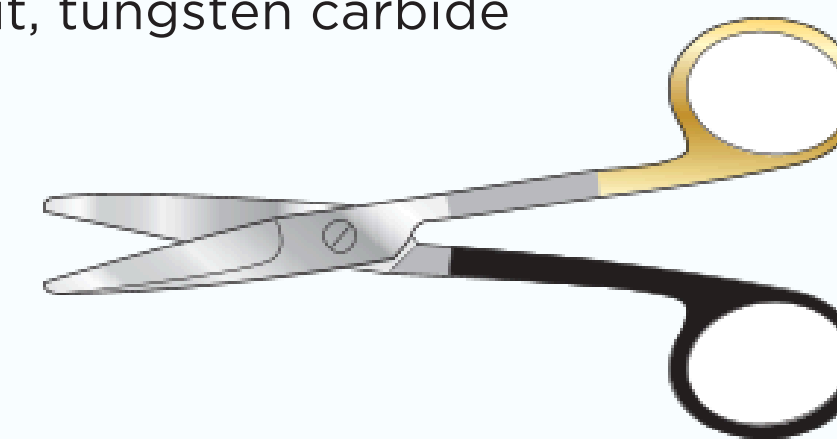

Straight

SC-GI/163	140mm long
SC-GI/163a	160mm long
SC-GI/165	190mm long
SC-GI/165a	230mm long

Curved

SC-GI/164	140mm long
SC-GI/164a	160mm long
SC-GI/166	190mm long
SC-GI/166a	230mm long

Metzenbaum Dissecting Scissors

Supercut, tungsten carbide

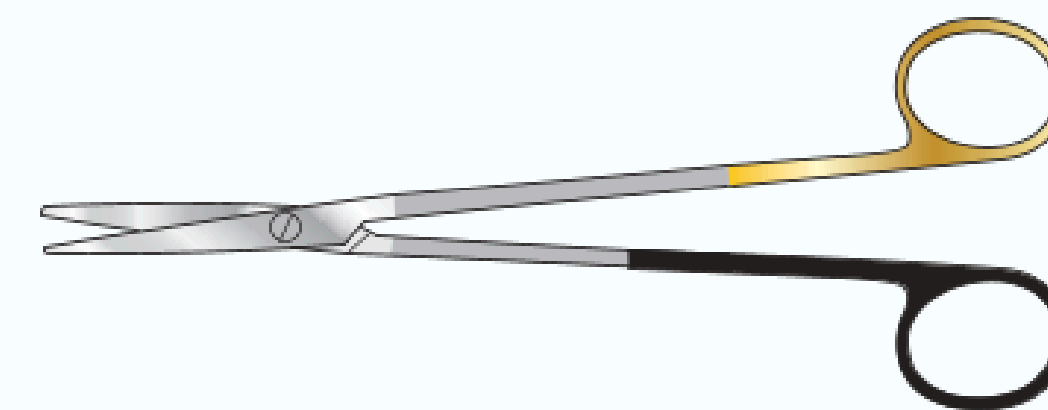

Straight

SCGI/188tc	185mm long
SC-GI/188tca	200mm long
SC-GI/188tcb	230mm long
SC-GI/188tcc	250mm long
SC-GI/188tcd	280mm long

Curved

SCGI/191tc	147mm
SC-GI/189tc	185mm
SC-GI/186tca	200mm
SC-GI/188tcb	230mm
SC-GI/188tcc	250mm
SC-GI/188tcd	280mm

Dressing Scissors

Supercut, tungsten carbide

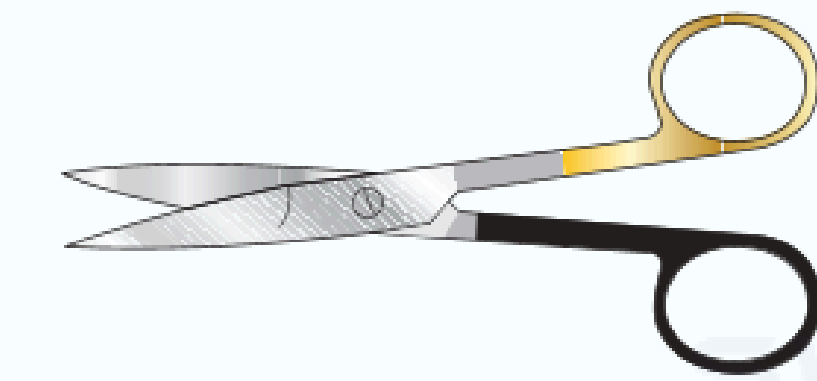

Blunt/Blunt

Straight

SC-GI/174	130mm long
SC-GI/176	145mm long
SC-GI/178	165mm long
SC-GI/180	185mm long

Curved

SCGI/175	130mm long
SC-GI/177	145mm long
SC-GI/179	165mm long
SC-GI/180a	185mm long

Blunt/Sharp

Straight

SCGI/167	130mm long
SC-GI/169	145mm long
SC-GI/171	165mm long
SC-GI/173	185mm long

Curved

SCGI/168	130mm long
SC-GI/170	145mm long
SC-GI/172	165mm long
SC-GI/173a	185mm long

Sharp/Sharp

Straight

SCGI/181	130mm long
SC-GI/183	145mm long
SC-GI/185	165mm long
SC-GI/187	185mm long

Curved

SC-GI/182	130mm long
SC-GI/184	145mm long
SC-GI/186	165mm long
SC-GI/187a	185mm long

Dressing Scissors

Supercut, blunt/blunt



145mm long

SC-GI/160	Straight
SC-GI/161	Curved

Dressing Scissors

Supercut, blunt/sharp

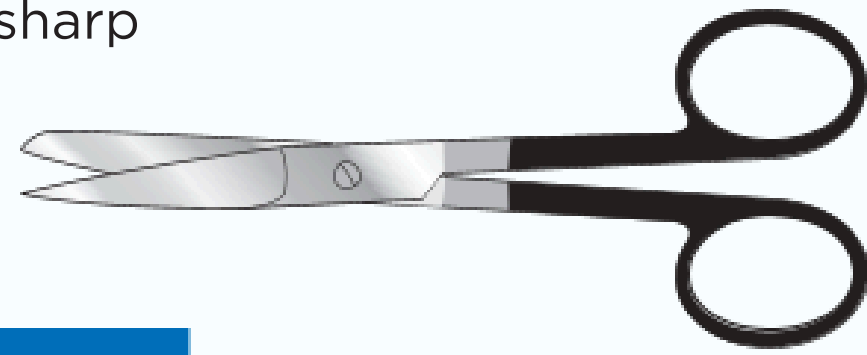

145mm long

SCGI/156	Straight
SC-GI/157	Curved

Dressing Scissors

Supercut,sharp/sharp

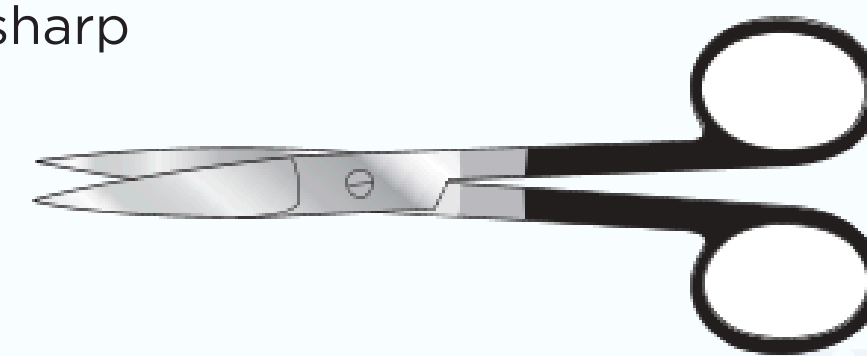

145mm long

SCGI/158	Straight
SC-GI/159	Curved

Mayo Scissors

Supercut

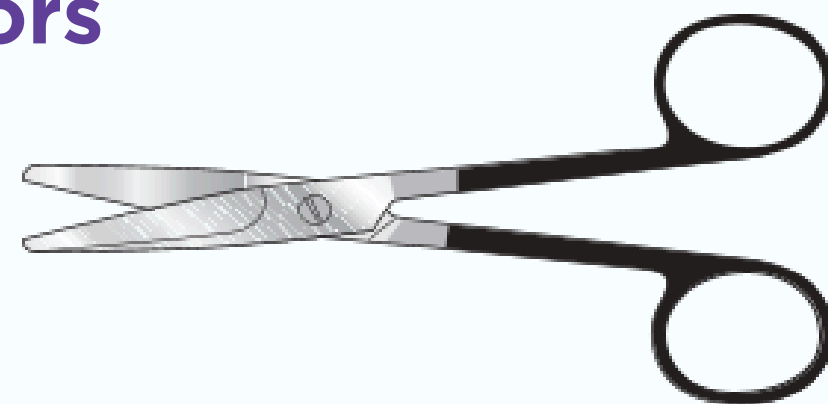

Straight

SCGI/166a	140mm long
SC-GI/166e	160mm long
SC-GI/166b	170mm long

Curved

SC-GI/166c	140mm long
SC-GI/166f	160mm long
SC-GI/166d	170mm long

Boyd Scissors

Supercut, blunt/blunt

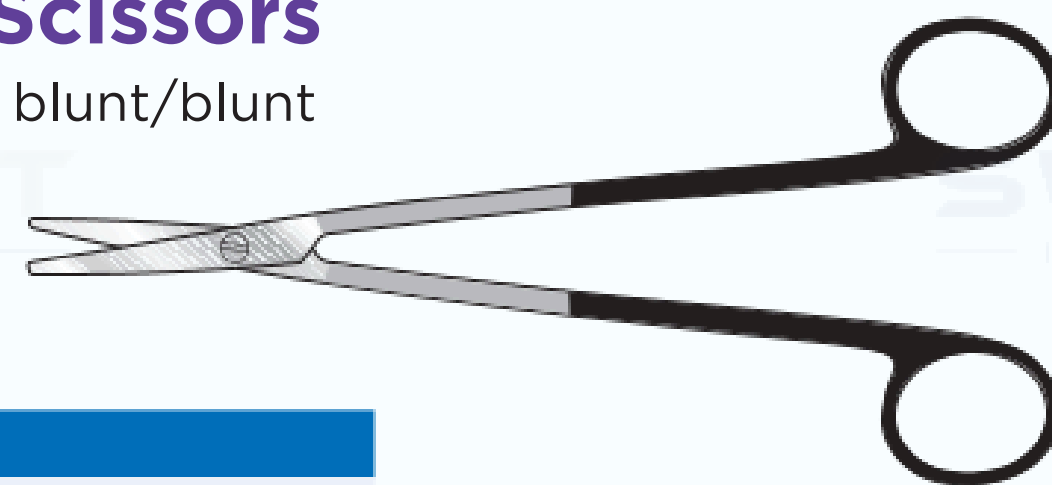

SC 047	180mm long
--------	------------

Metzenbaum Dissecting Scissors

Supercut

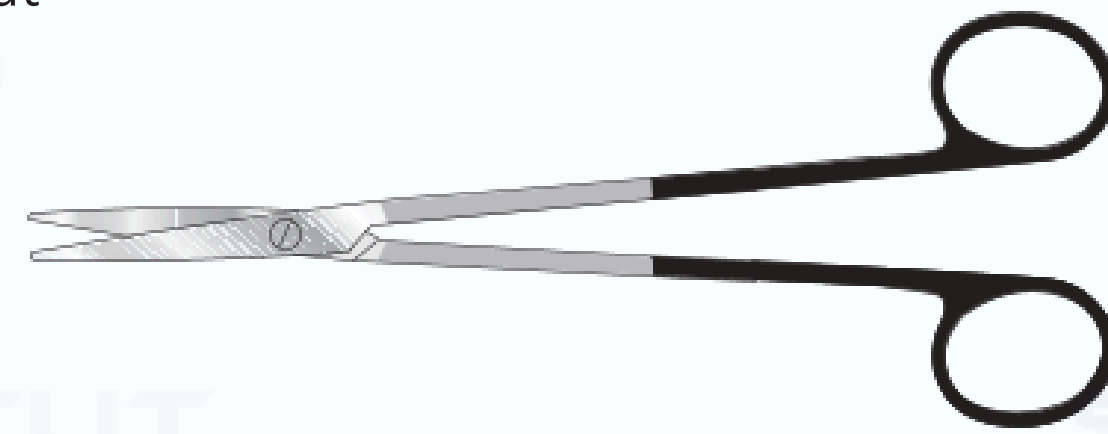

Straight (length)

SC-GI/190	147mm
SC-GI/188	185mm
SC-GI/188a	200mm
SC-GI/188b	230mm
SC-GI/188c	250mm
SC-GI/188d	280mm

Curved (length)

SC-GI/191	147mm
SC-GI/189	185mm
SC-GI/186a	200mm
SC-GI/186b	230mm
SC-GI/186c	250mm
SC-GI/186d	280mm

Stevens Tenotomy Scissors

Supercut



Curved/blunt

SC-OP/424	114mm long
S C - O P/424 a	125mm long
SC-OP/424gb	135mm long

Curved/sharp

SCOP/425	114mm long
SC-OP/425a	140mm long
SC-OP/425b	160mm long

With cutout, 110mm long

SCOP/426	Straight/blunt, 114mm long	S C - O P/42 7a	Straight/blunt
SC-OP/427	Straight/sharp, 114mm long	SC-OP/427b	Curved/blunt
SC-OP/427c	Straight/sharp, 180mm long		

Strabismus Scissors

Supercut



114mm long

SC-GI/475	Straight
SC-GI/475a	Curved

Iris Scissors

Supercut

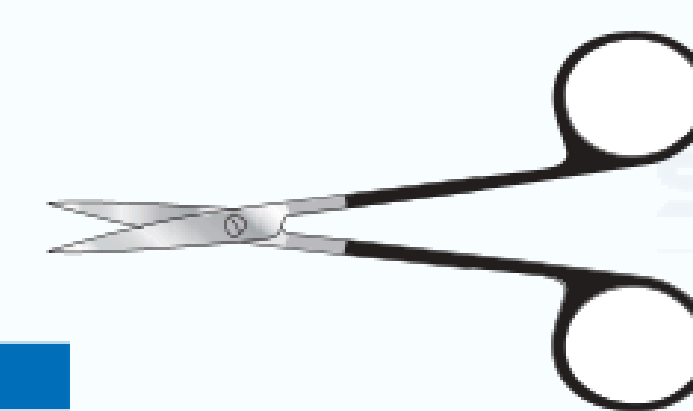

114mm long

SC-OP/476	Straight
S C - O P/476 a	Curved

Bruce Clarke Needle Holder

Screw joint

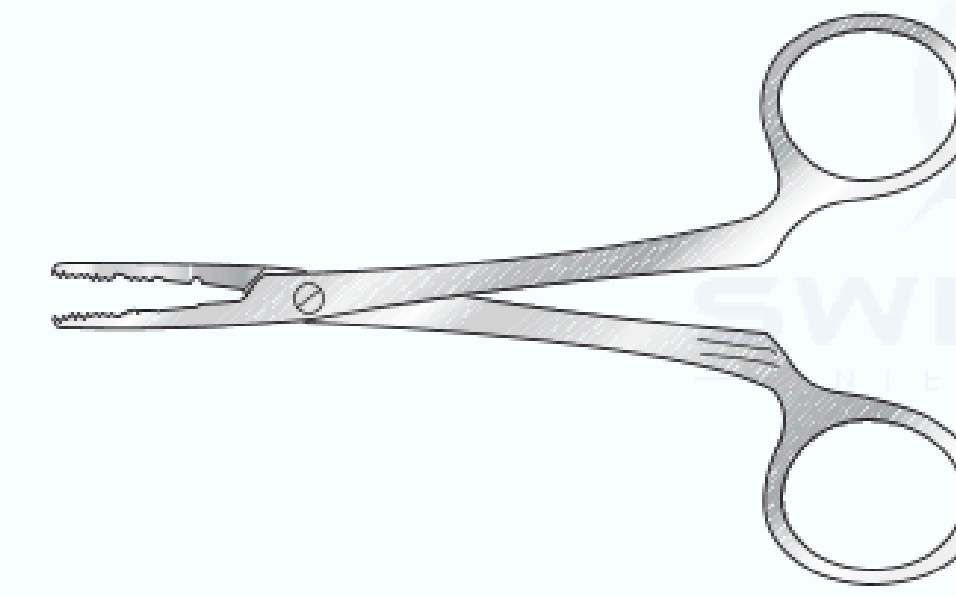

SC-GI/205	127mm long
-----------	------------

Crile-Wood Needle Holder

Straight, baby, fine

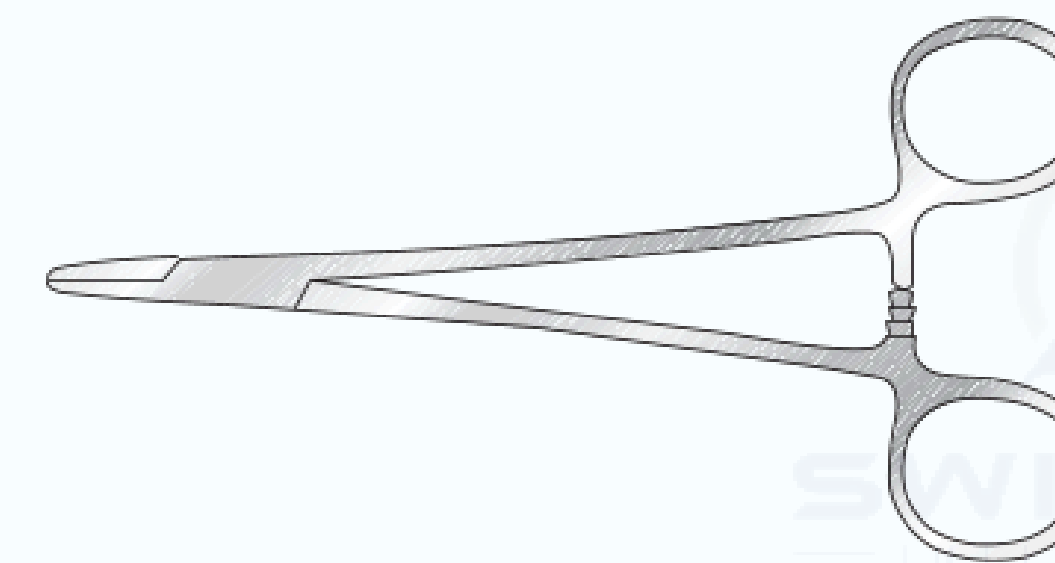

SC-GI/199	150mm long
-----------	------------

Kilner Needle Holder

Box joint, cross-serrated jaw

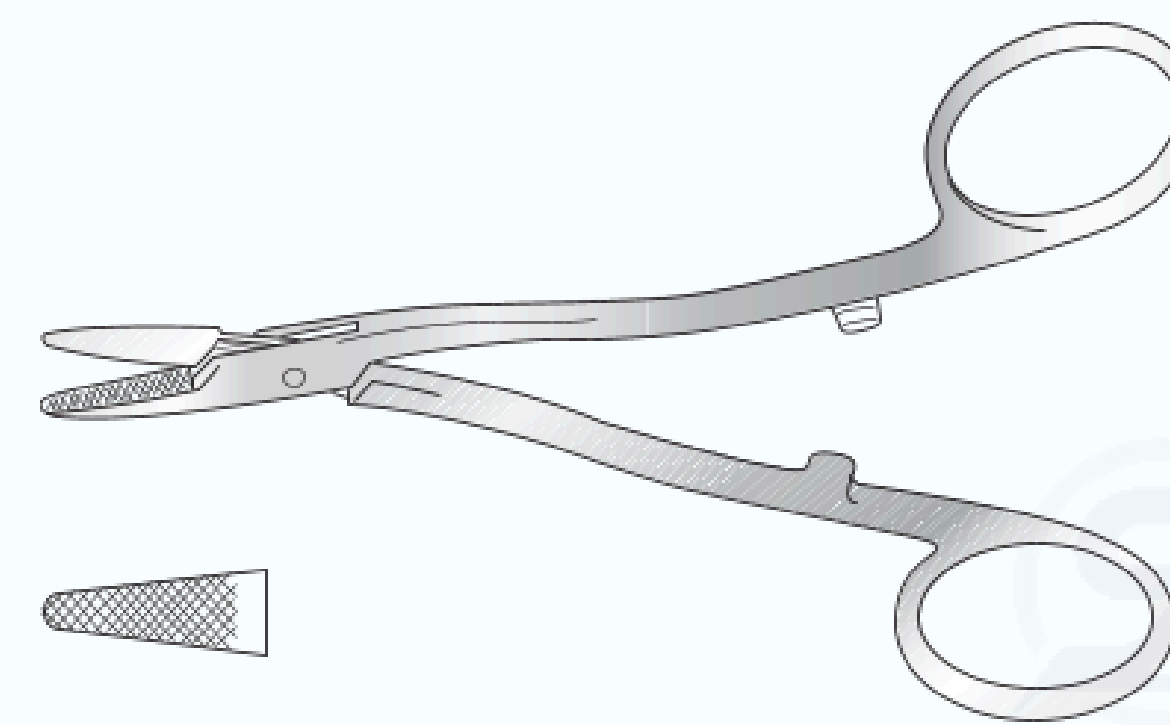

SC-GI/200	165mm long
SC-GI/201	133mm long

Lawrence Needle Holder

Fine jaw, 150mm long

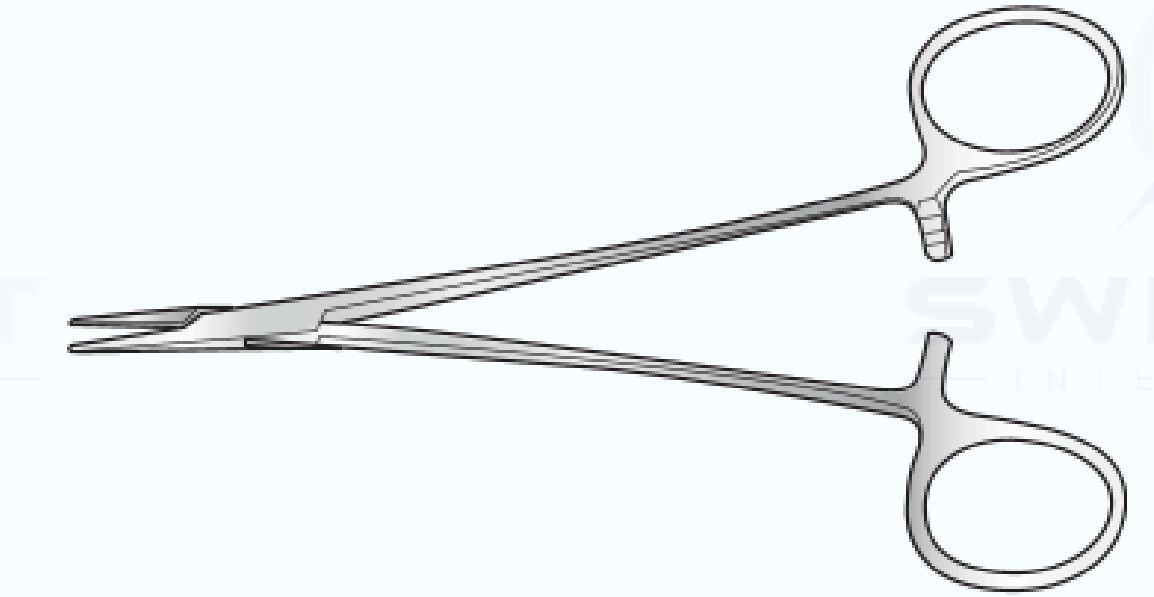

SC-PL/012b	Tungsten carbide jaw
------------	----------------------

Needle Holder

box joint, lightweight, with curved plain jaws and one offset bow for thumb

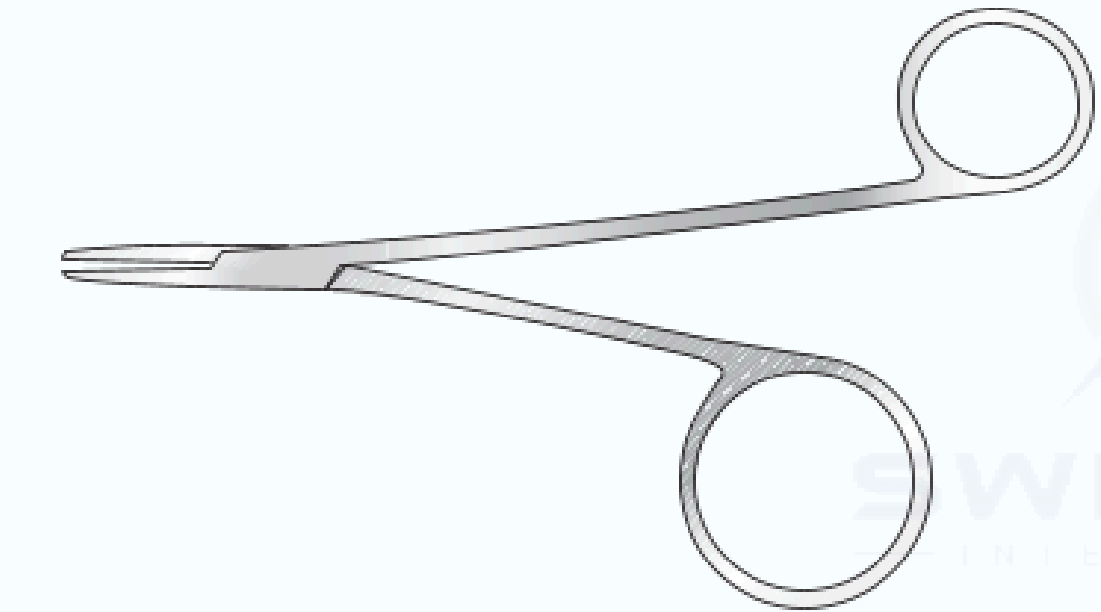

SC-GI/209	152mm long
-----------	------------

MacPhail Needle Holder

Screw joint, with one copper jaw

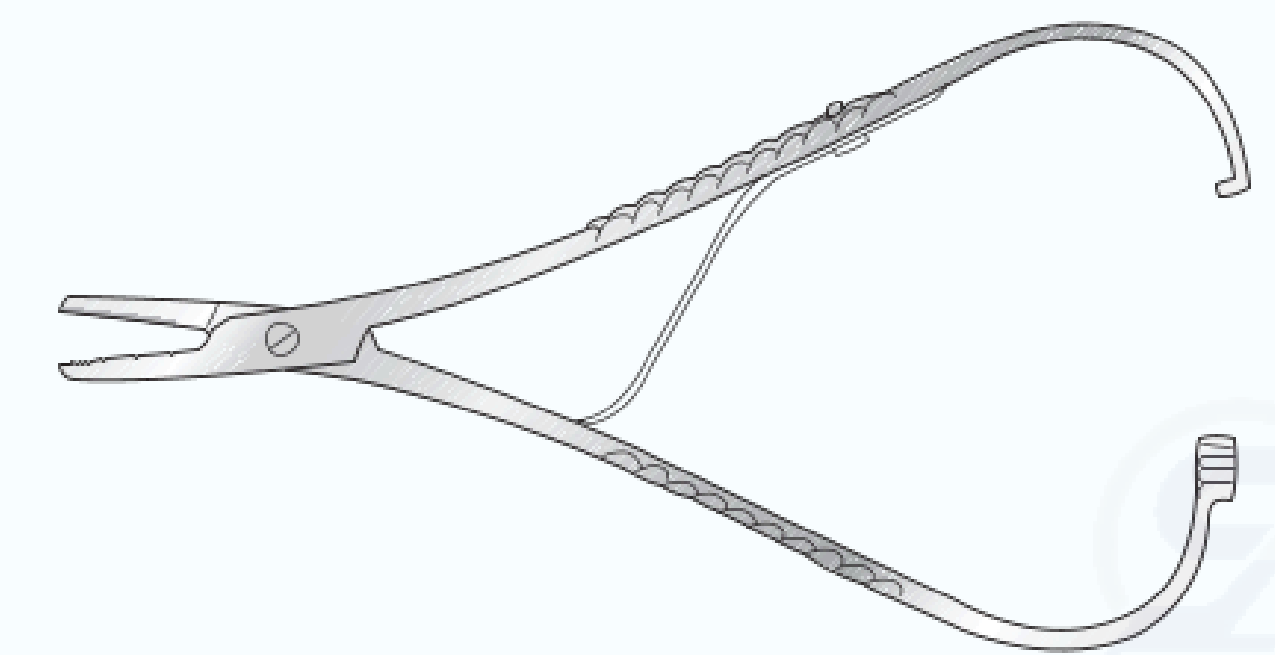

SC-GI/206	159mm long
SC-GI/207	178mm long
SC-GI/208	209mm long

Mathieu Needle Holder

Screw joint

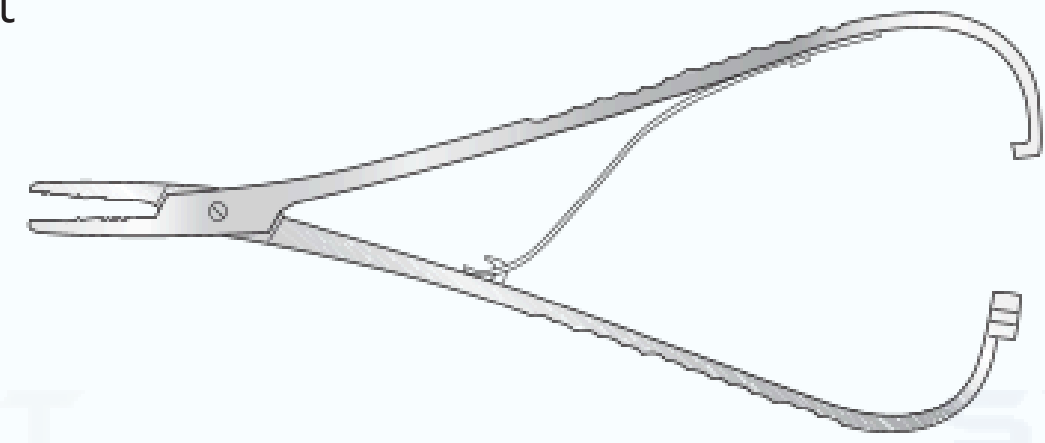

SC-GI/210	172mm long
SC-GI/211	209mm long
SC-GI/212	243mm long

Mayo Needle Holder

Box joint, straight

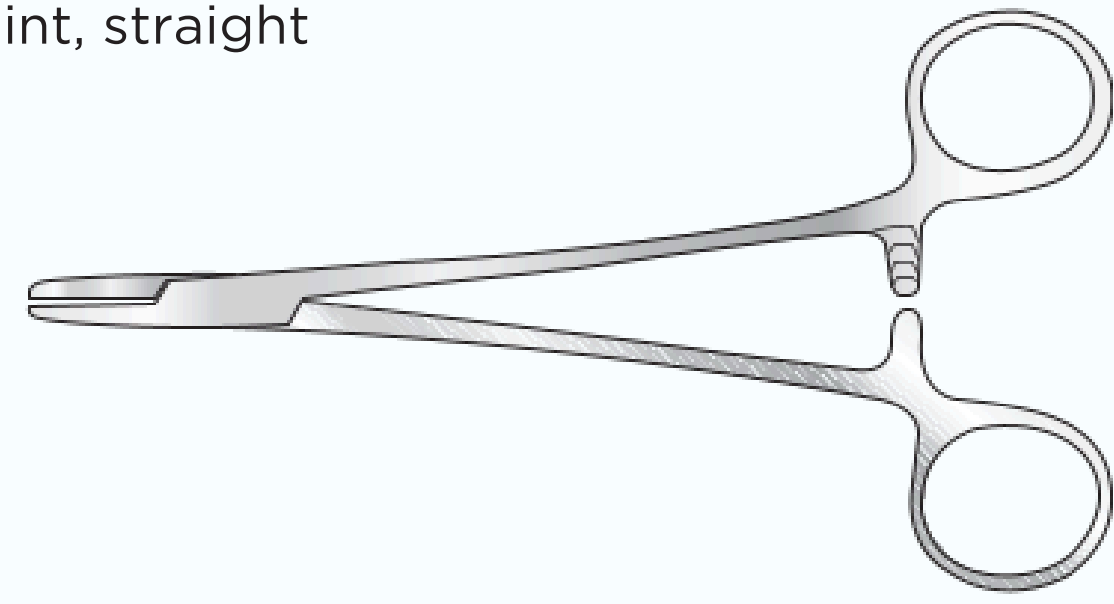

Wide cross serrated jaws

SCGI/224	159mm long
SC-GI/398	203mm long

Narrow cross serrated jaws

SC-GI/225	159mm long
-----------	------------

Naughton Morgan Needle Holder

Box joints, cross serrated jaws

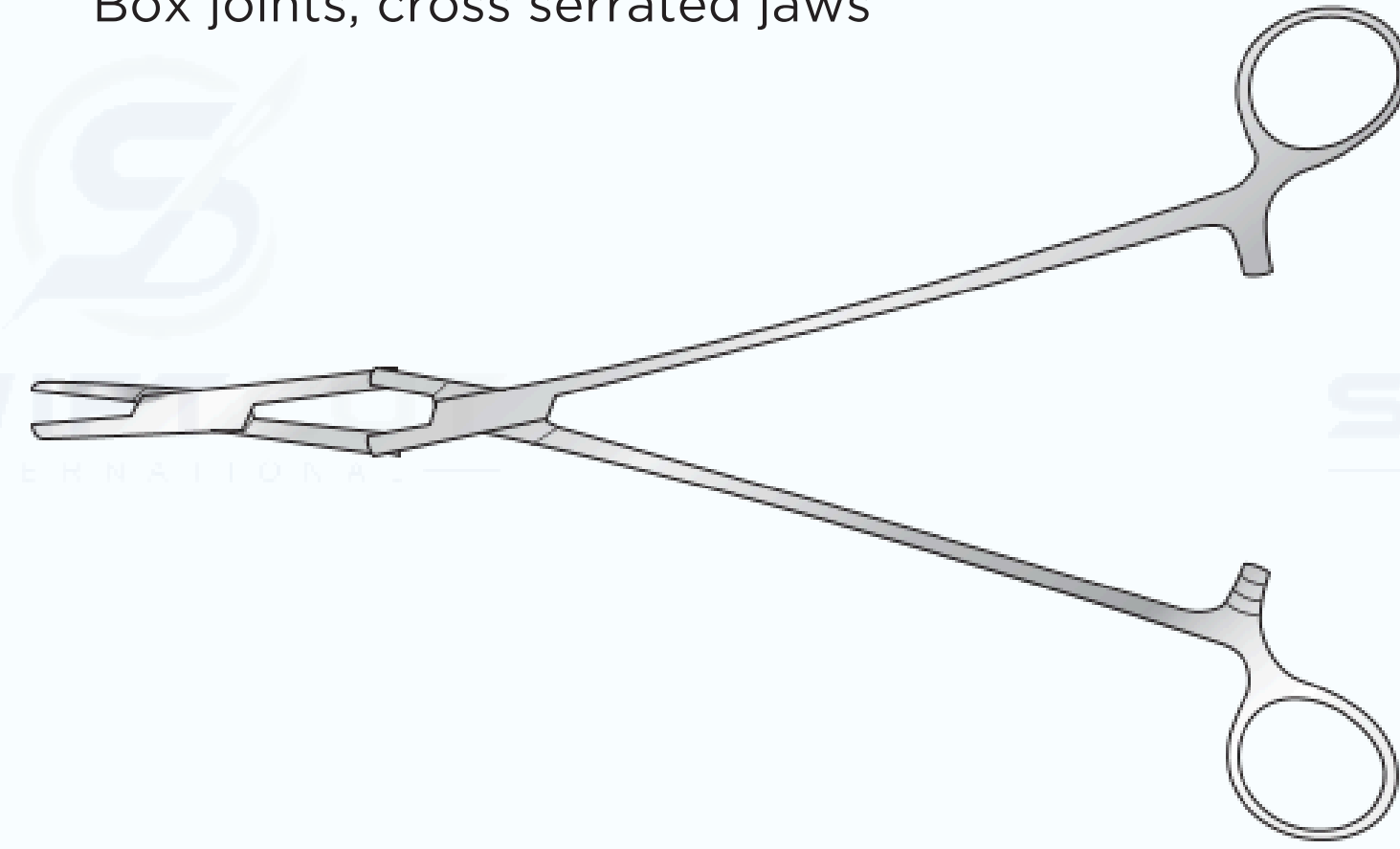

SC-GI/399	185mm long
SC-GI/400	254mm long

Tungsten carbide

SC-GI/401	185mm long
SC-GI/402	254mm long

Rochester-Mayo Needle Holder

Screw joint

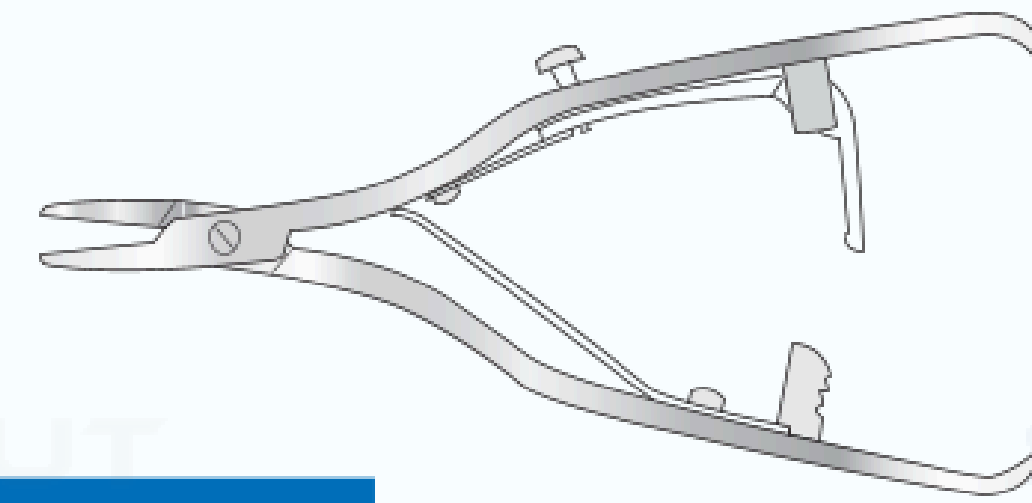

SC-GI/213	178mm long
-----------	------------

Berry Needle Holder/Wire Twister

Tungsten carbide jaws

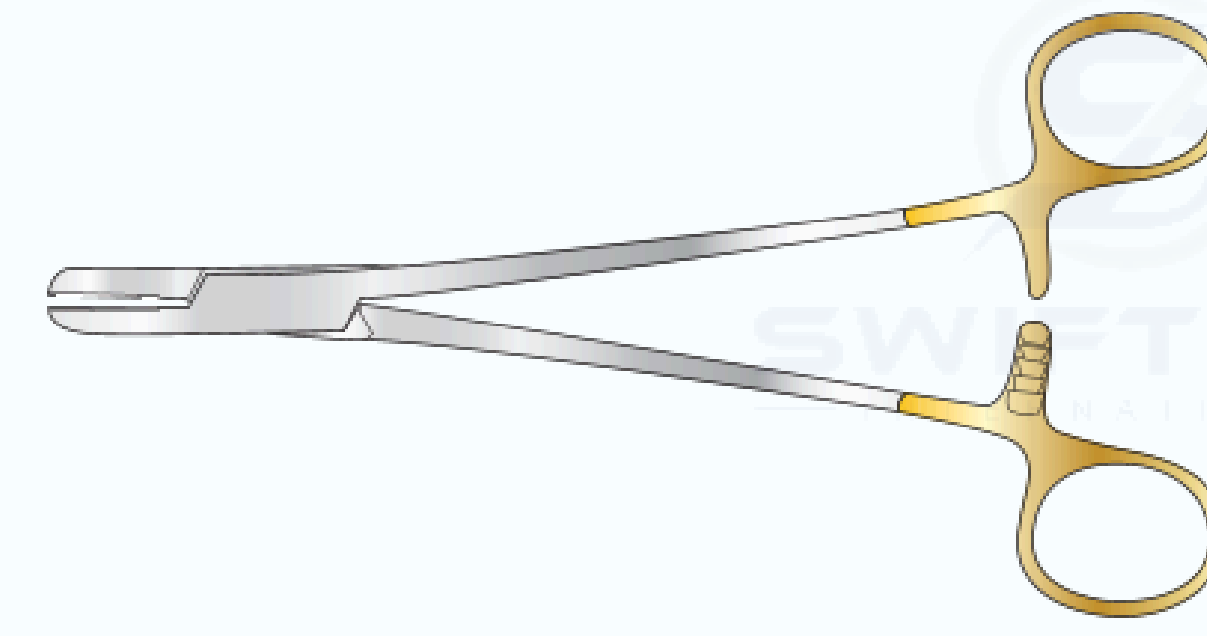

SC-GI/467	200mm long
-----------	------------

Crile-Wood Needle Holder

Tungsten carbide insert, box joint, satin finish, straight

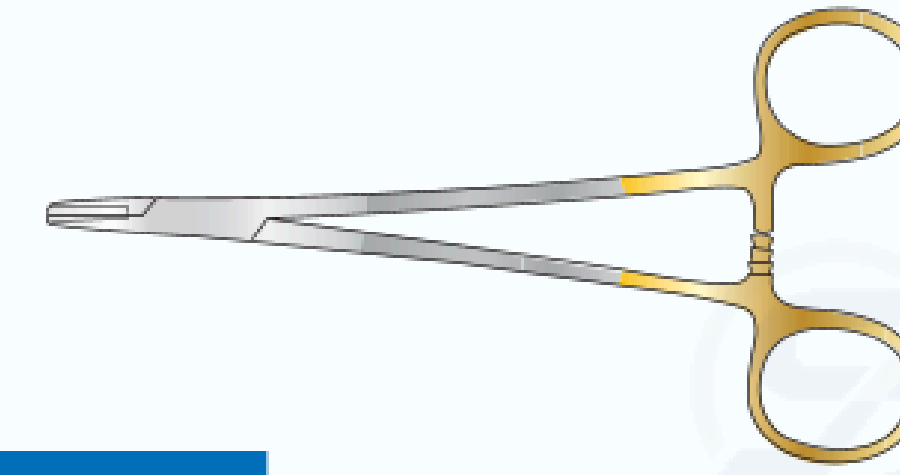

SCGI/217	159mm long
SC-GI/218	178mm long
SC-GI/198	150mm long

Derf Needle Holder

Tungsten carbide insert

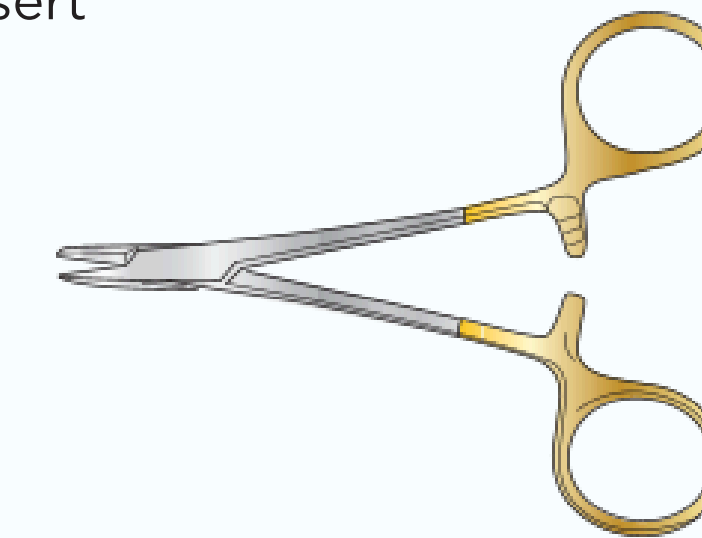

SC-GI/BUPHF002	115mm long
----------------	------------

Finochietto Needle Holder

Tungsten carbide jaws

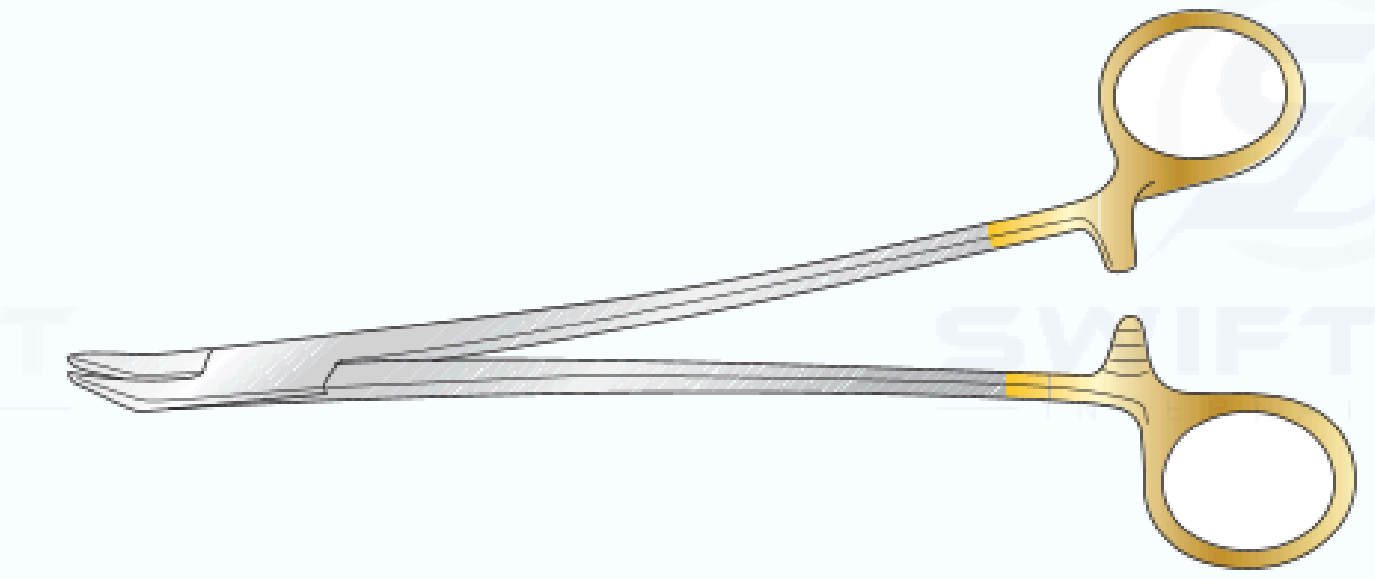

SCGI/222	215mm long
SC-GI/223	265mm long

Halsey Needle Holder

Tungsten carbide insert, box joint, satin finish, straight

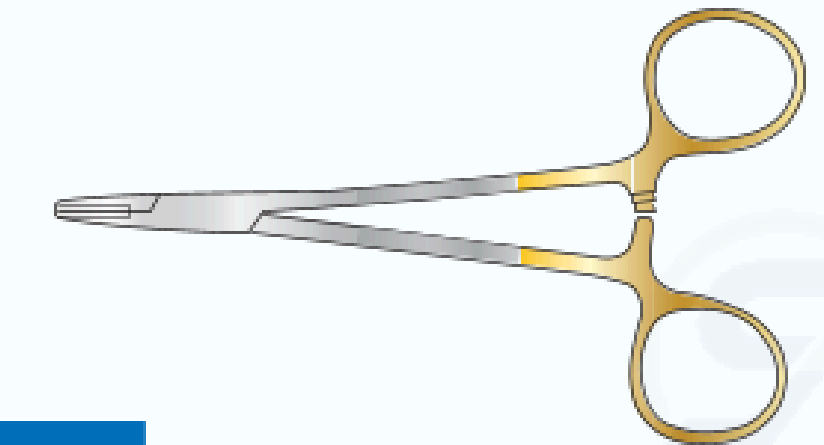

SC-GI/220	127mm long
-----------	------------

Kilner Needle Holder

Tungsten carbide insert

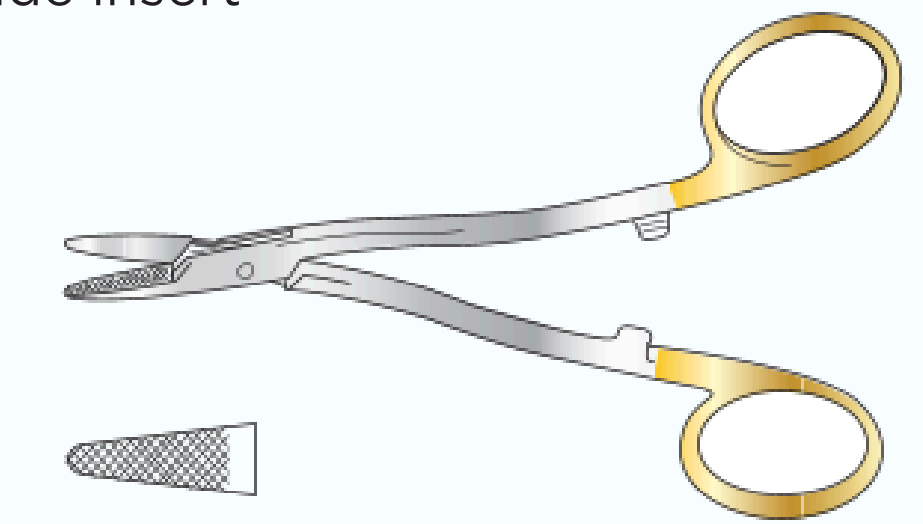

SC-GI/221	140mm long
-----------	------------

Masing Needle Holder

Tungsten carbide insert, one angled bow

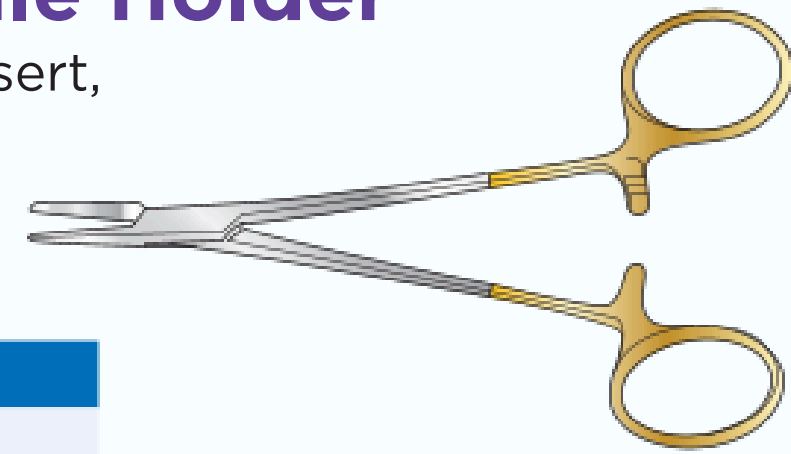

SC-GI/009R	130mm long
------------	------------

Nievert Needle Holder

Tungsten carbide insert, box joint, satin finish, straight

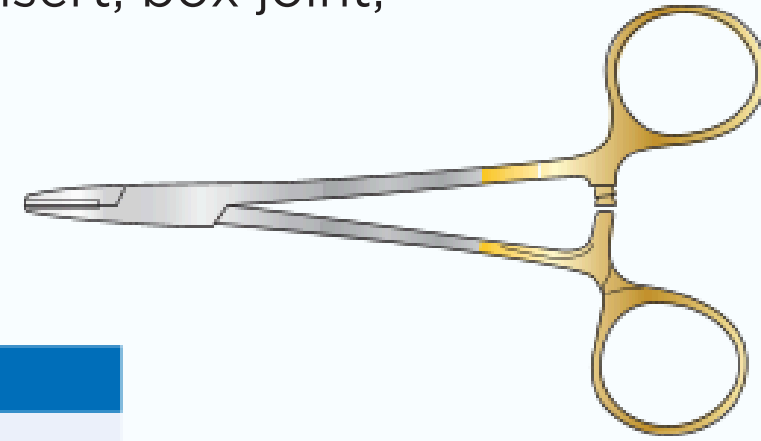

SC-GI/219	127mm long
-----------	------------

DeBakey Needle Holder

250mm long

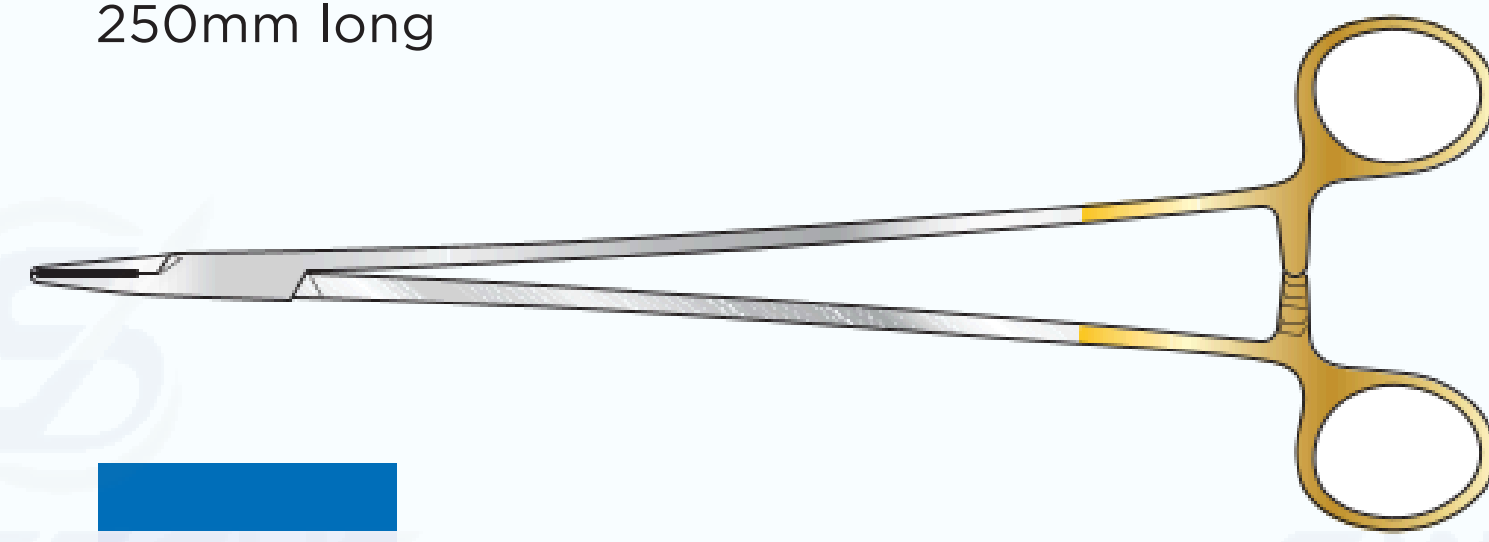

THO/SC-5642a

Ryder Needle Holder

Tungsten carbide insert, box joint, satin finish, straight

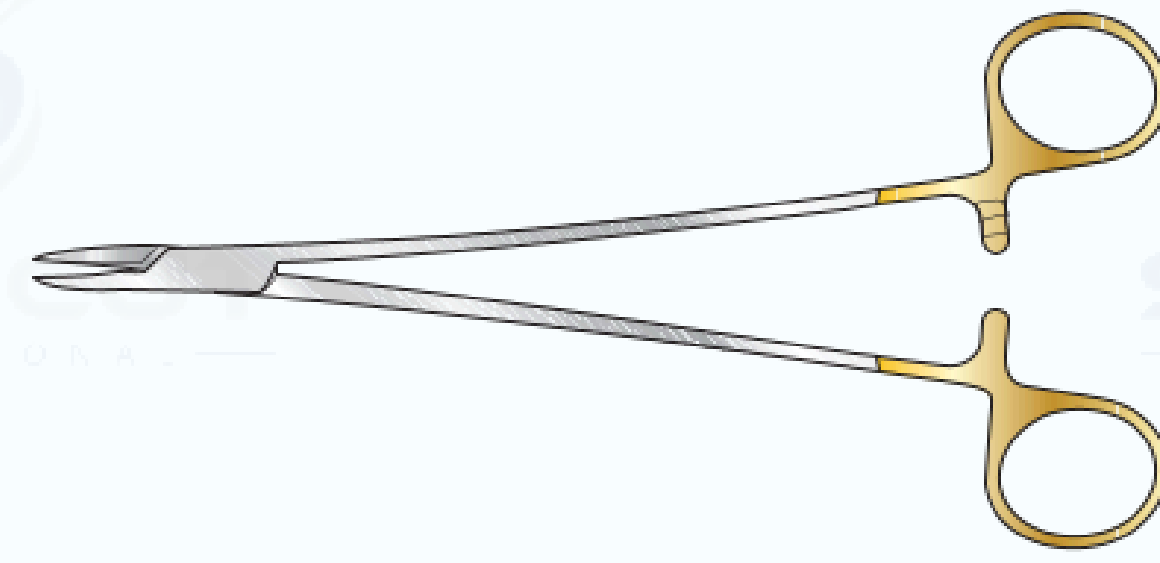

0.2mm jaw pitch

SC-GI/SH-5197a	135mm long
SC-GI/SH-5197b	155mm long
SC-GI/SH-5197c	175mm long
SC-GI/SH-5197d	210mm long

0.4mm jaw pitch

SC-GI/SH-5198a	135mm long
SC-GI/SH-5198b	155mm long
SC-GI/SH-5198c	175mm long
SC-GI/SH-5198d	210mm long

Sarot Needle Holder

Diamond jaw, tungsten carbide, gold plated bows

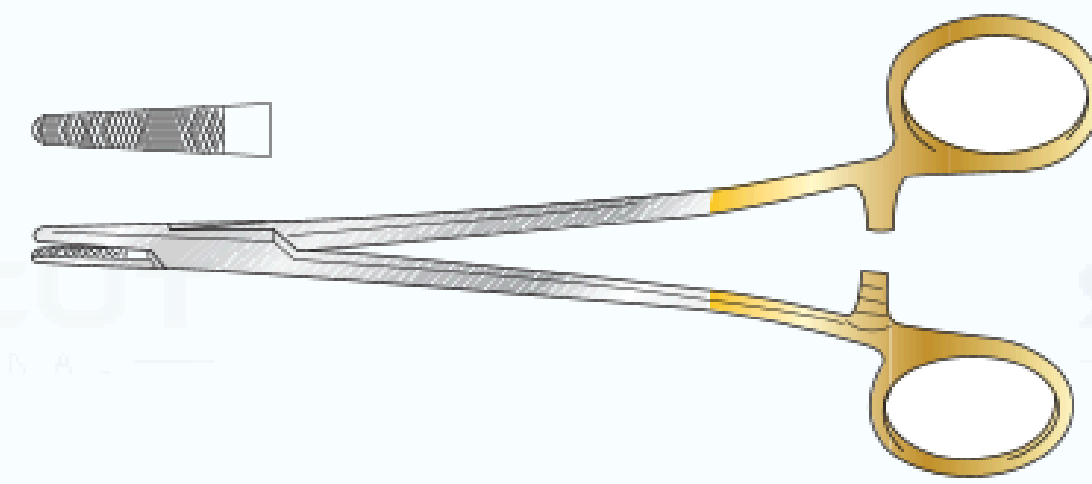

SC-GI/451	181mm long
-----------	------------

Mayo-Hegar Needle Holder

Tungstencarbideinsert,boxjoint,satinfinish, straight

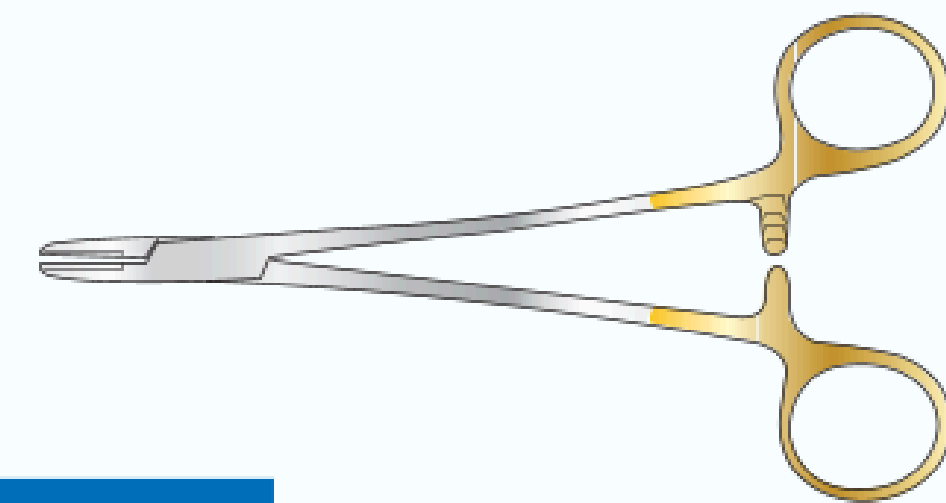

SC-GI/472	130mm long
SC-GI/214	159mm long
SC-GI/215	178mm long
SC-GI/216	209mm long

LONGER SIZES AVAILABLE

Olsen-Hegar Scissor/Needle Holder

With tungsten carbide insert

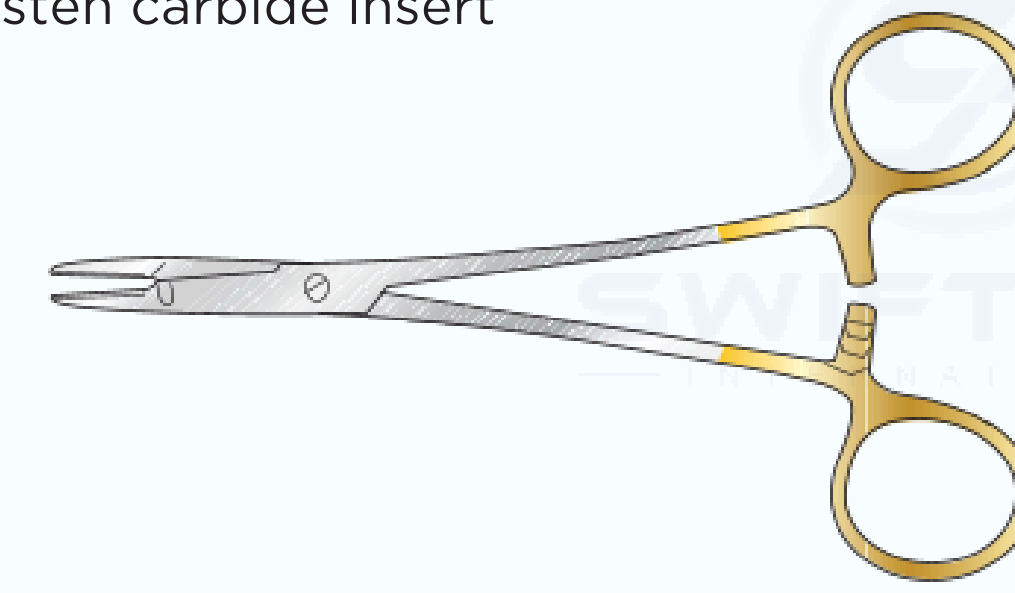

SCGI/229	147mm long
SC-GI/230	165mm long

Gillies Scissor/Needle Holder

Right-hand, with tungsten carbide insert

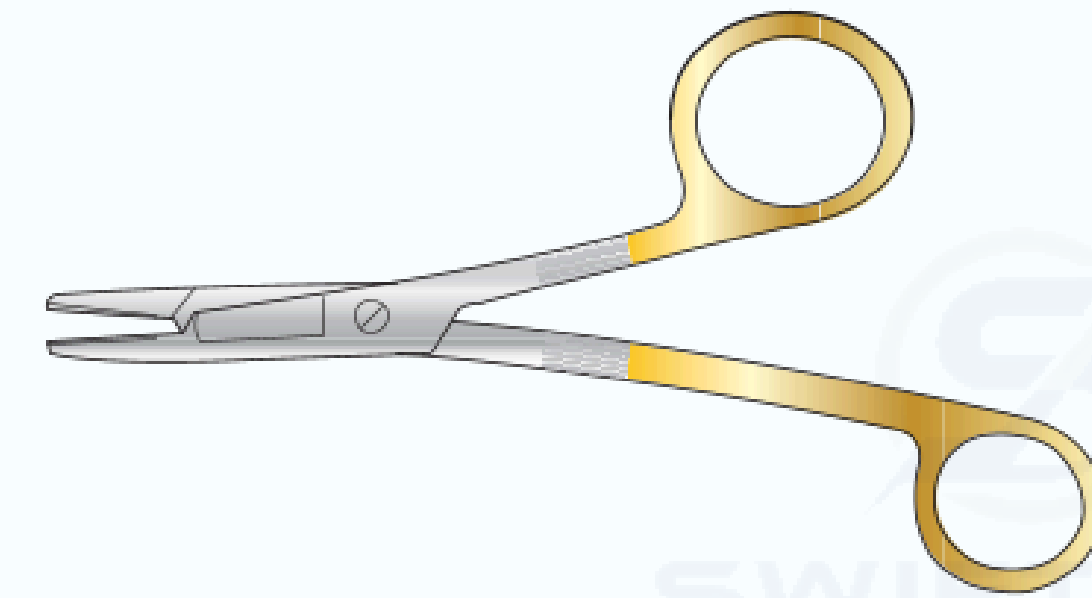

SC-GI/235	158mm long
-----------	------------

Gillies Scissor/Needle Holder

158 mm long



SC-GI/231	Right-hand
SC-GI/232	Left-hand

Olsen-Hegar Scissor/Needle Holder

Screw joint

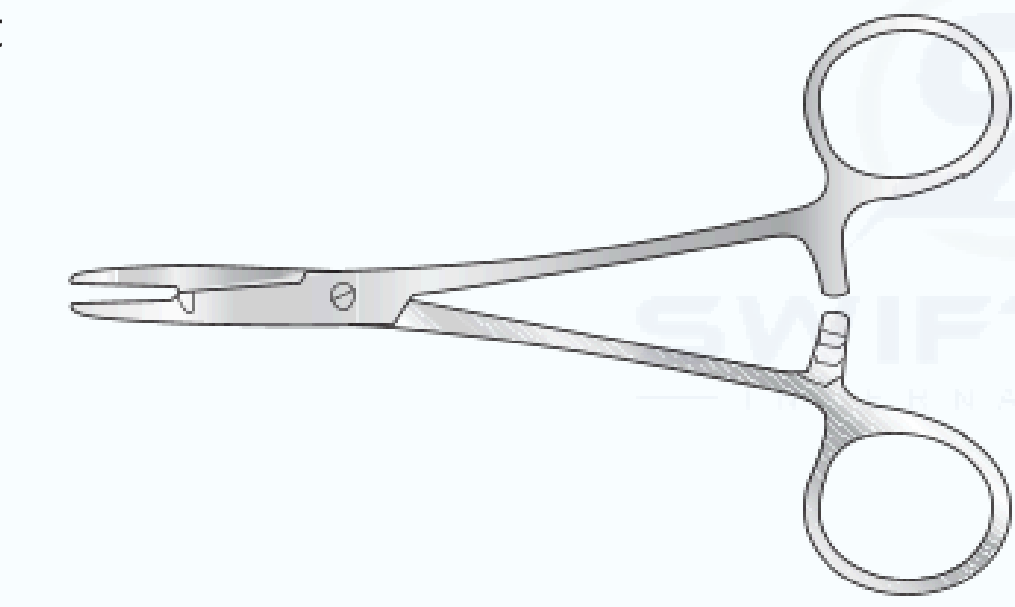

SCGI/226	140mm long
SC-GI/227	165mm long
SC-GI/228	190mm long

Gillies Scissor/Needle Holder

Heavy pattern, 158 mm long

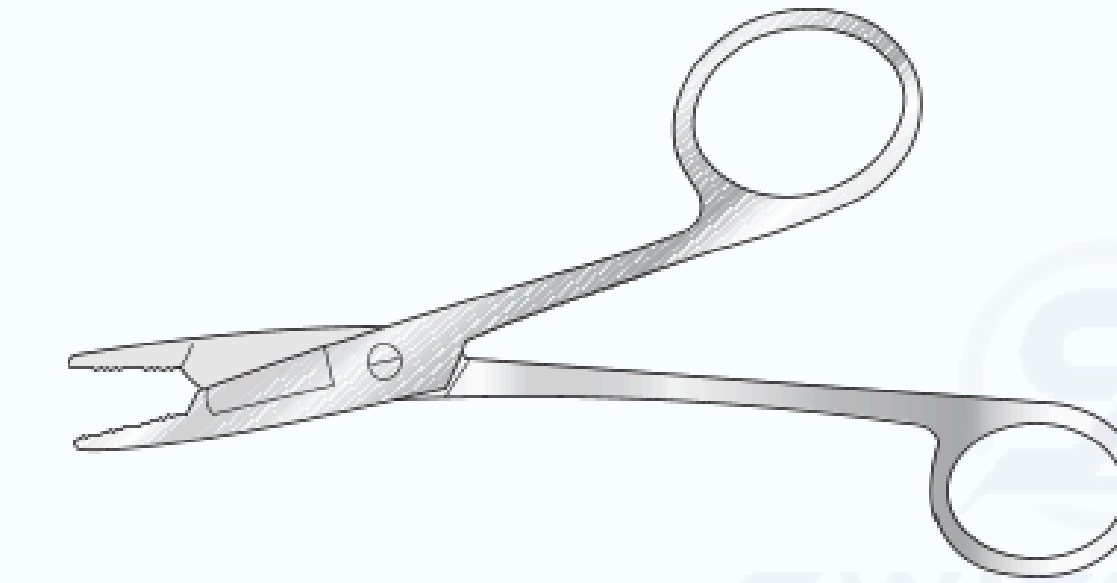

SCGI/233	Right-hand
SC-GI/234	Left-hand

Foster Gillies Scissor/Needle Holder

Fine pattern

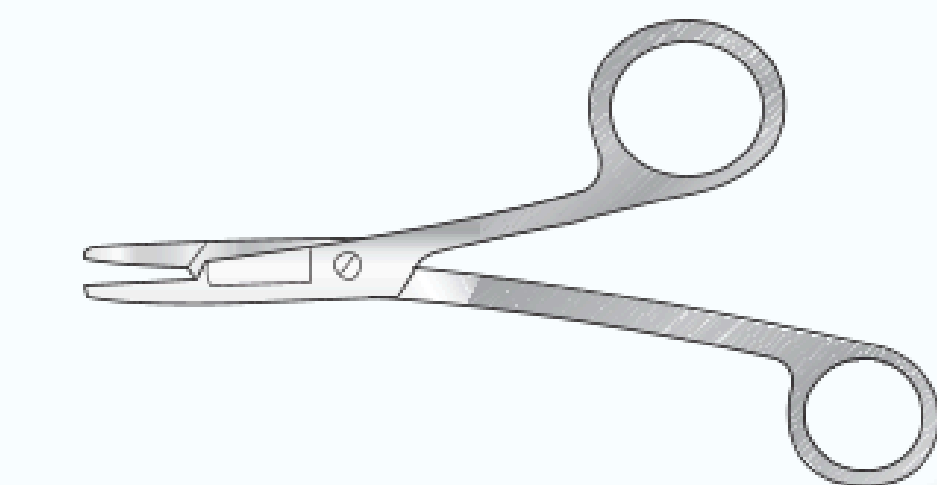

SC-GI/236	127mm long
-----------	------------

Spring Clip

Serrated pattern, stainless steel, for fixing slings to leg splints, also for towel clipping

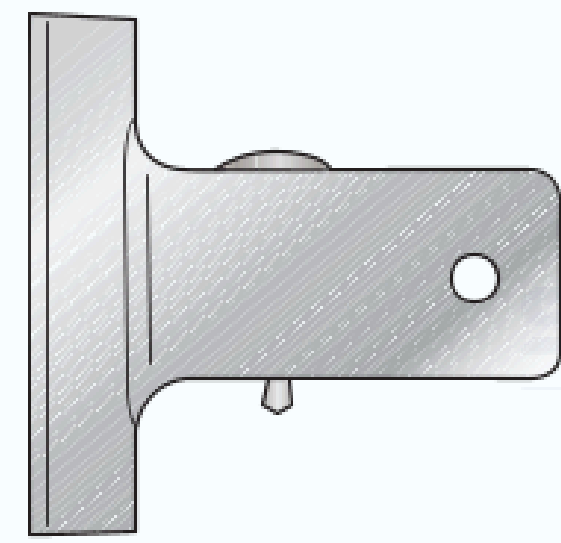

SC-GI/344	63mm wide
-----------	-----------

Spring Bag Clip

Serrated

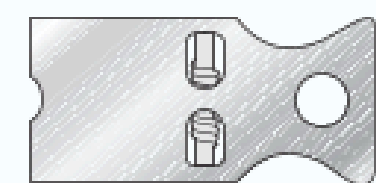

SC-GI/345	26mm wide
-----------	-----------

Jones Towel Clip

Superior quality spring forcep type

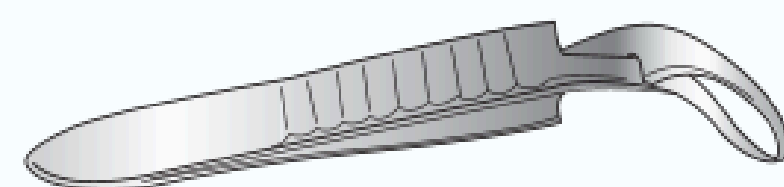

SC-GI/346	89mm long
-----------	-----------

Shardles Towel Clip

Spring curved, cross action

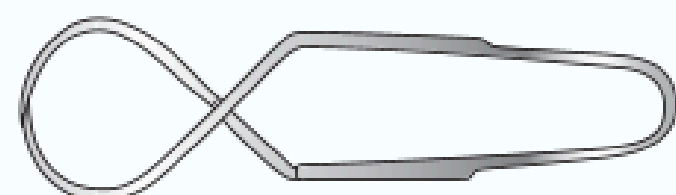

SC-GI/347	77mm long
-----------	-----------

Backhaus Towel Clip

Superior quality, box joint

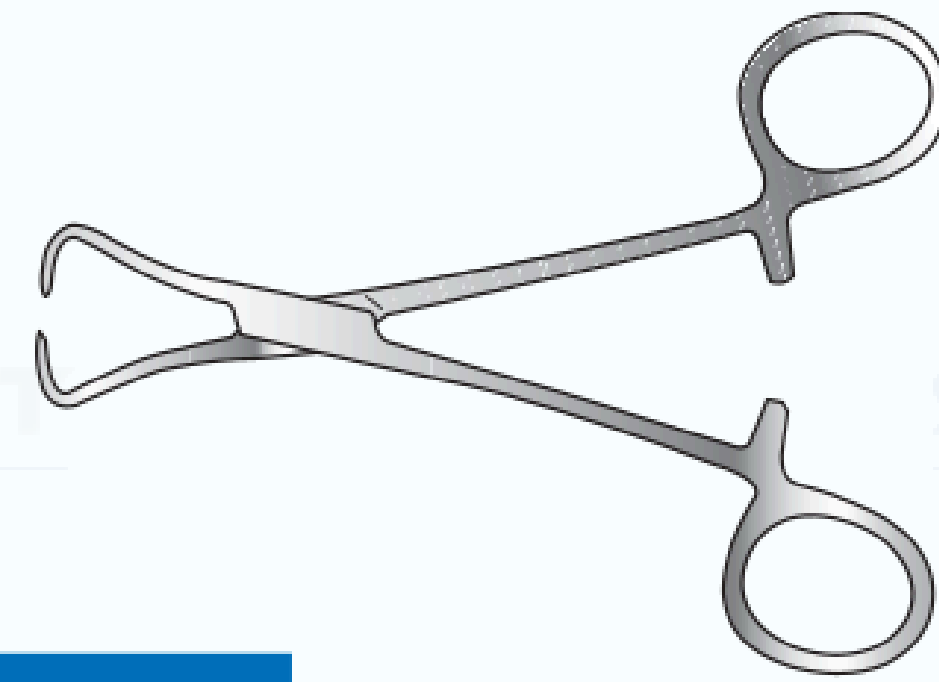

SCGI/348	89mm long
SC-GI/348a	102mm long
SC-GI/349	130mm long

Moynihan Towel Clip

Screw joint, 2-2teeth, for sides of incision

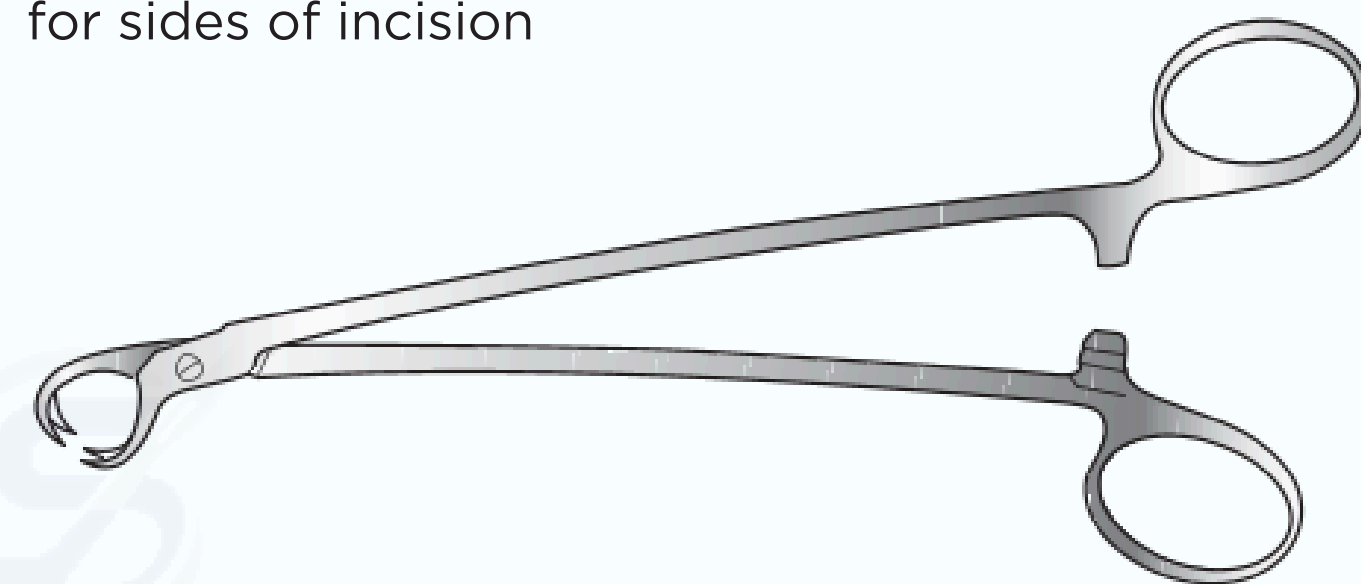

SC-GI/470	191mm long
-----------	------------

Ball and Socket Towel Forceps

Box joint

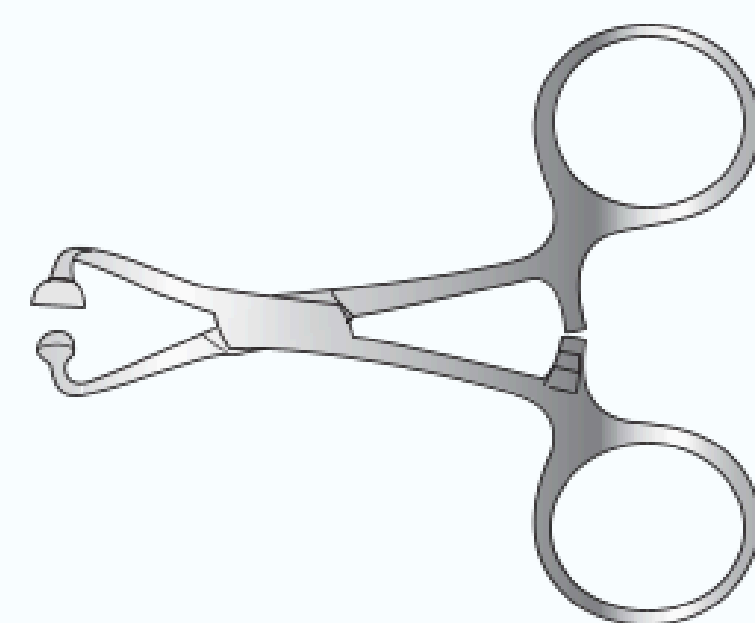

SC-GI/350	89mm long
SC-GI/351	115mm long
SC-GI/352	140mm long

Goligher Retractor

Complete with 2 centre blades:
1 x 90mm wide x 50mm deep
1 x 90mm wide x 90mm deep

and 2 pairs of lateral blades:
1 pair 25mm wide x 45mm deep
1 pair 50mm wide x 90mm deep

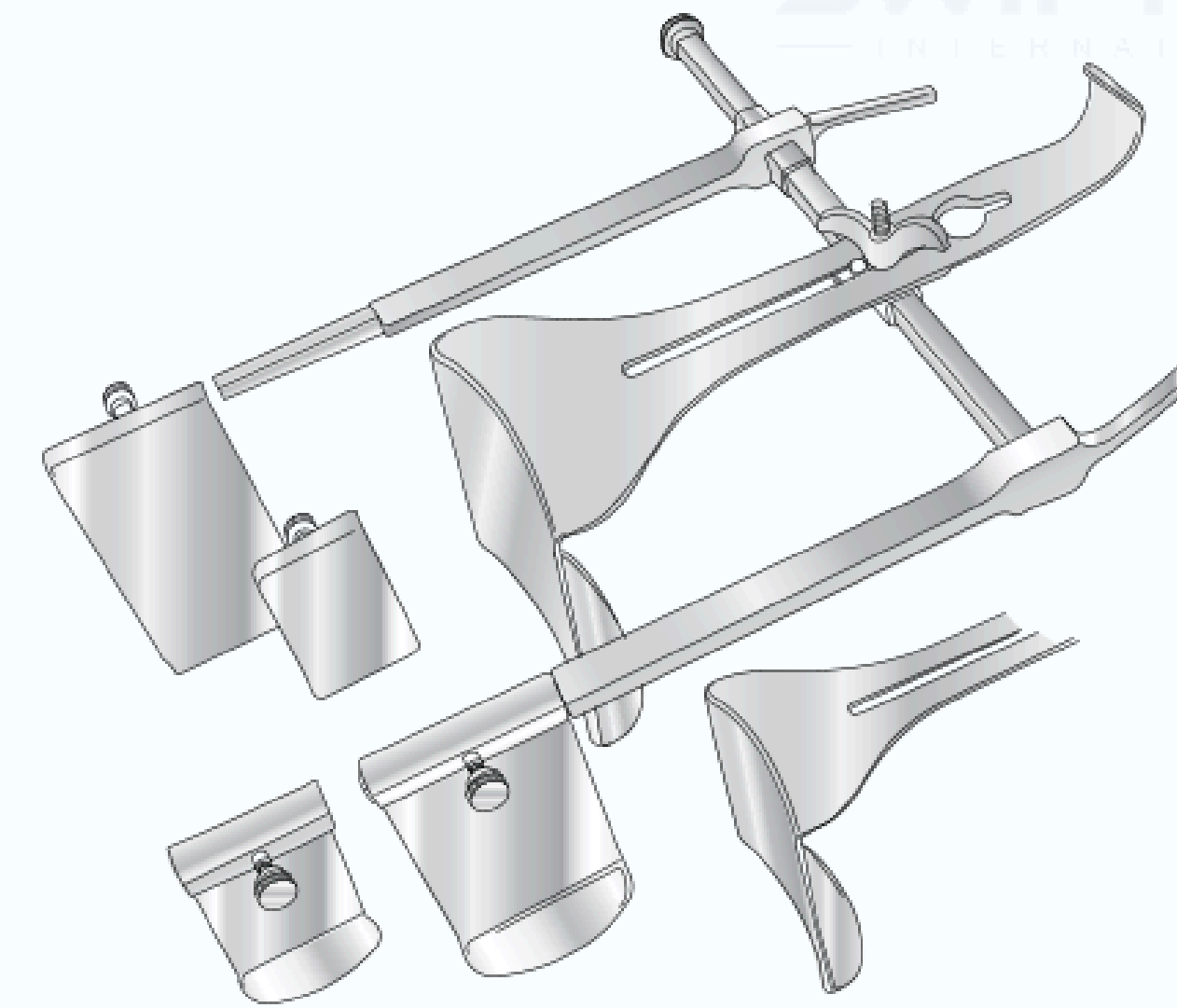

SC-GI/305

Balfour Abdominal Retractor

Trivalve, frame 203mm

Child
102mm opening, 51mm deep lateral blades,
38mm deep centre blade

Adult
178mm opening, 64mm deep lateral blades,

Extralarge
178mm opening, 102mm deep lateral blades,
108mm deep centre blade
44mm deep centre blade

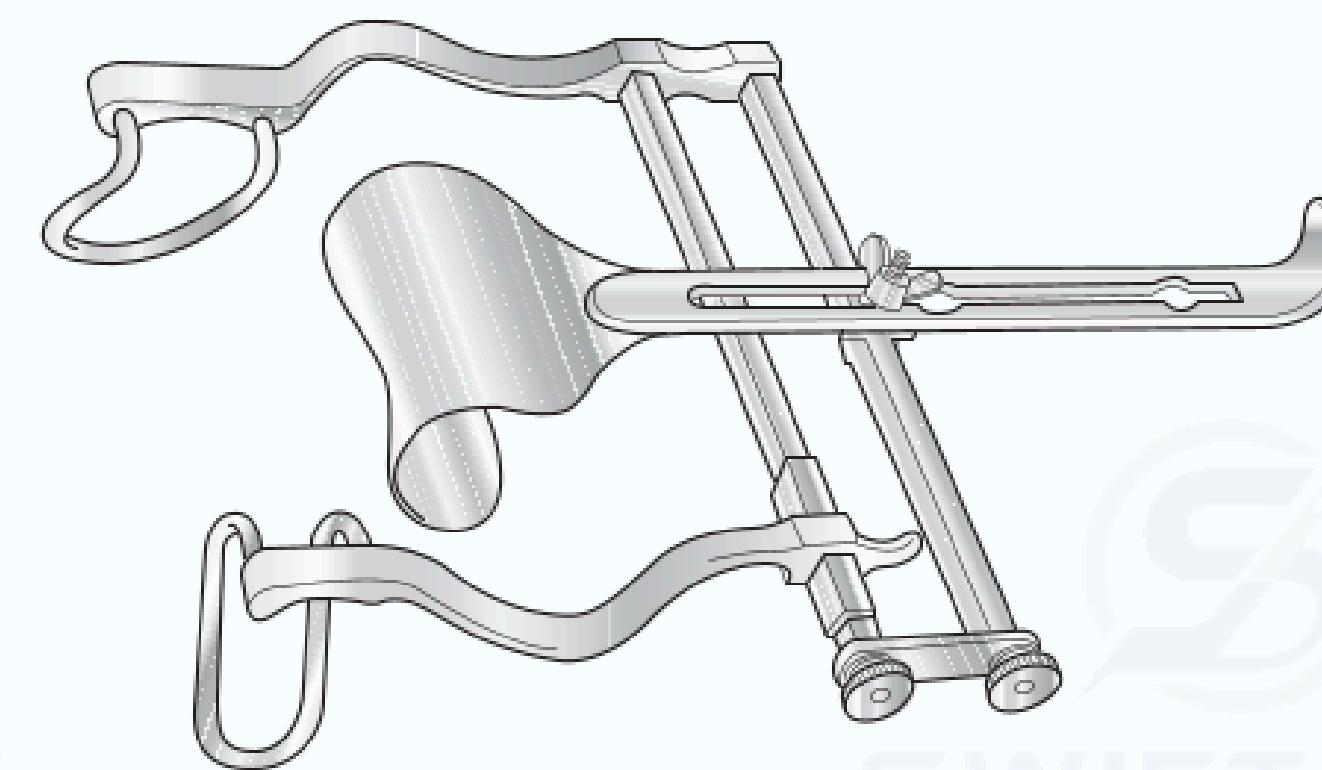

SCGI/373	Child
SC-GI/374	Adult
SC-GI/375	Extra large

Miles Retractor

Complete with 2 centre blades:
1 x 90mm wide x 50mm deep
1 x 90mm wide x 75mm deep

and 2 pairs of lateral blades:
1 pair 80mm wide x 35mm deep
1 pair 80mm wide x 75mm deep

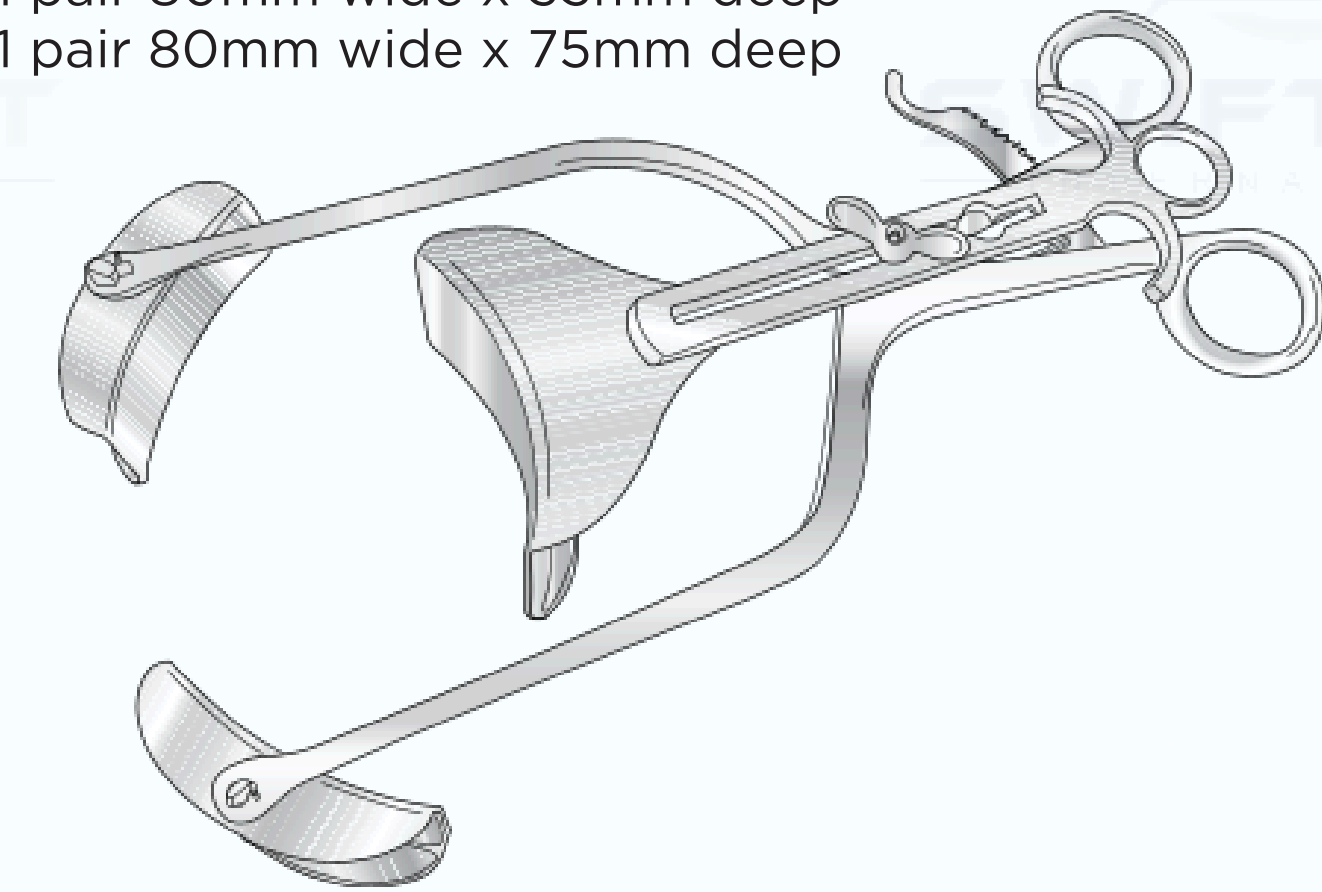

SC-GI/376	340mm long
-----------	------------

OTHER BLADE SIZES AVAILABLE

Balfour Abdominal Retractor

Bivalve, baby

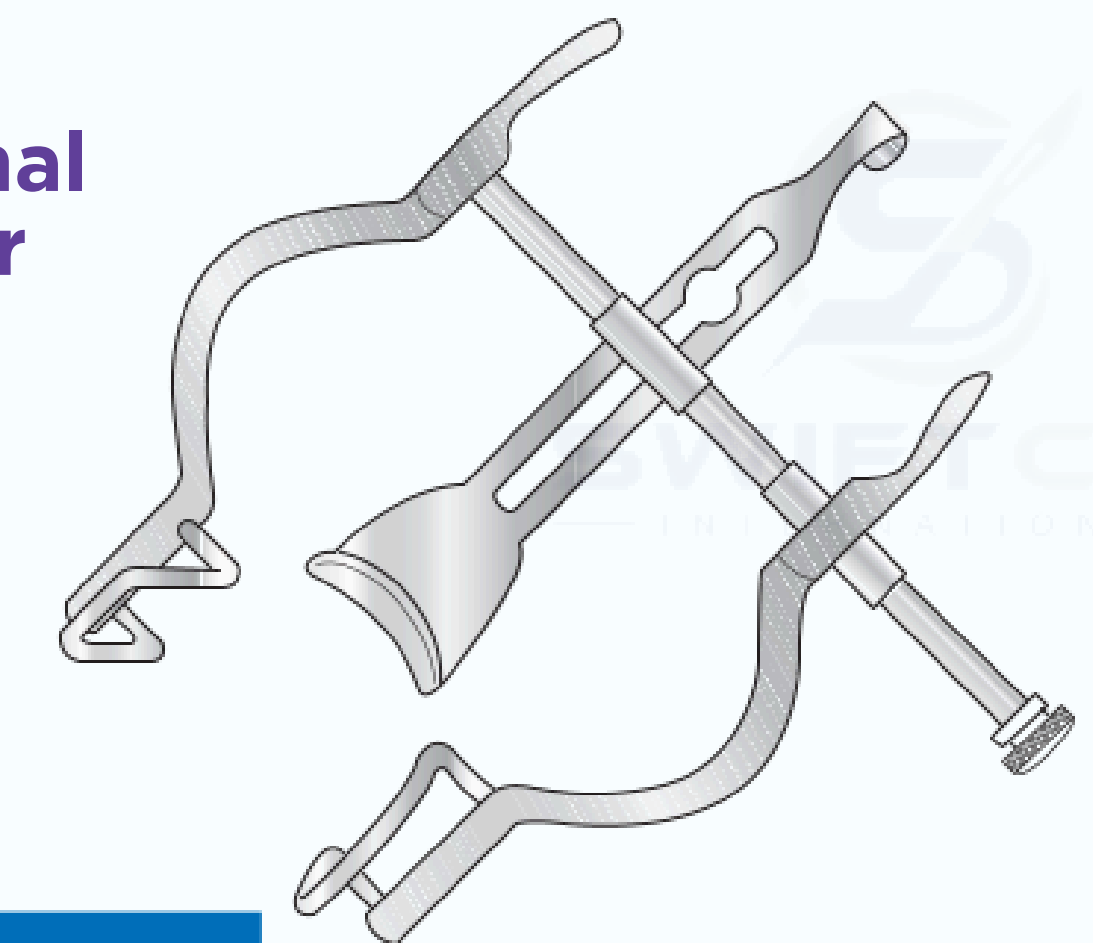

SC-GI/372	Fully open 89mm
-----------	-----------------

Berkeley Abdominal Retractor

Parallel action

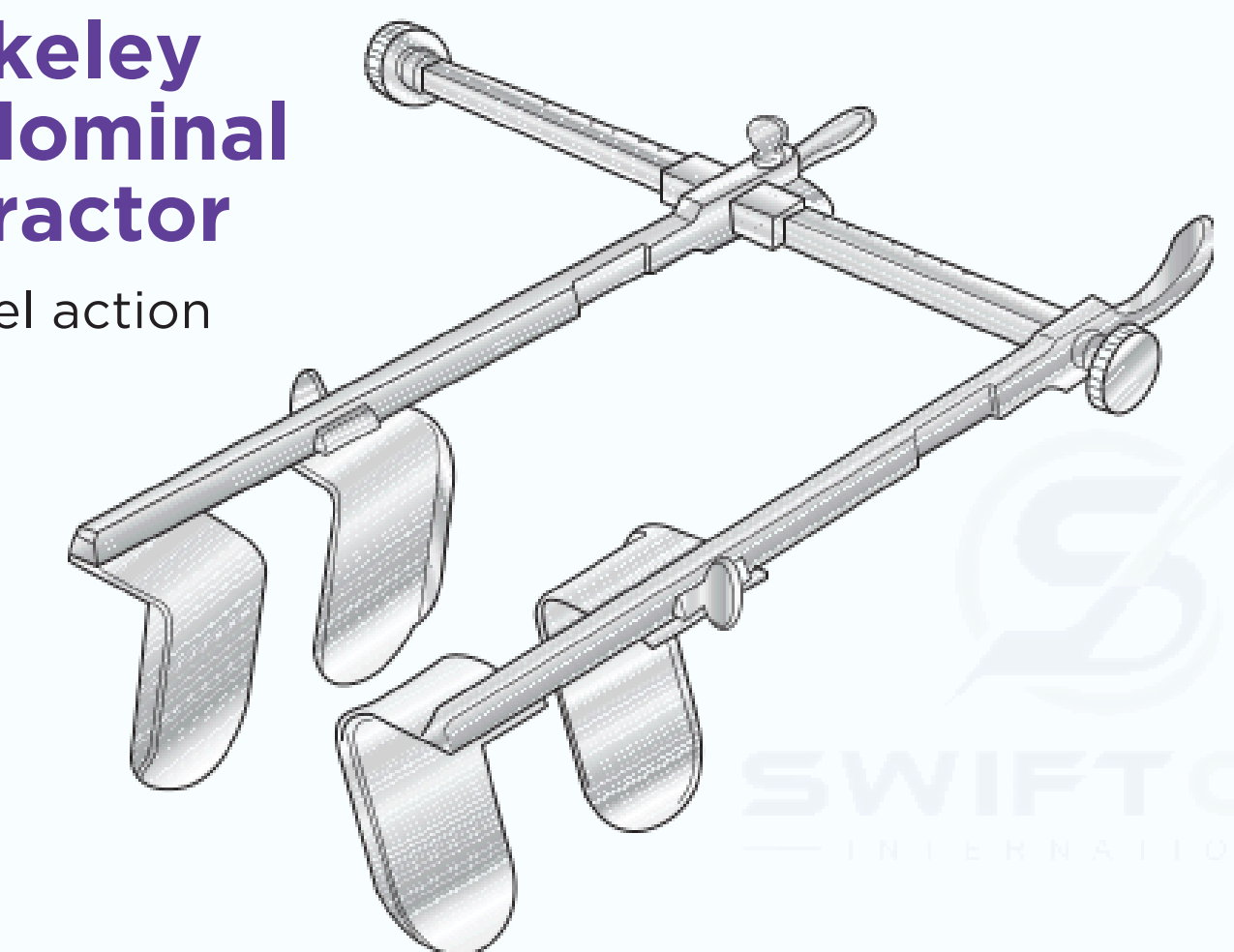

SC-GI/461	Blades 35mm x 60mm deep, 215mm long
-----------	-------------------------------------

Turner Warwick Universal Self Retaining Retractor

SC-GI/520	With frames A/B/C/D and blades A/B/C/D/E/F/K/L
SC-GI/521-A	Circular frame A only 178mm
SC-GI/521-B	Circular frame B only 229m
SC-GI/521-C	Circular frame C only 305mm
SC-GI/521-D	Oval frame D only 475mm x 330mm
SC-GI/521-E	Oval frame E only 370mm x 300mm

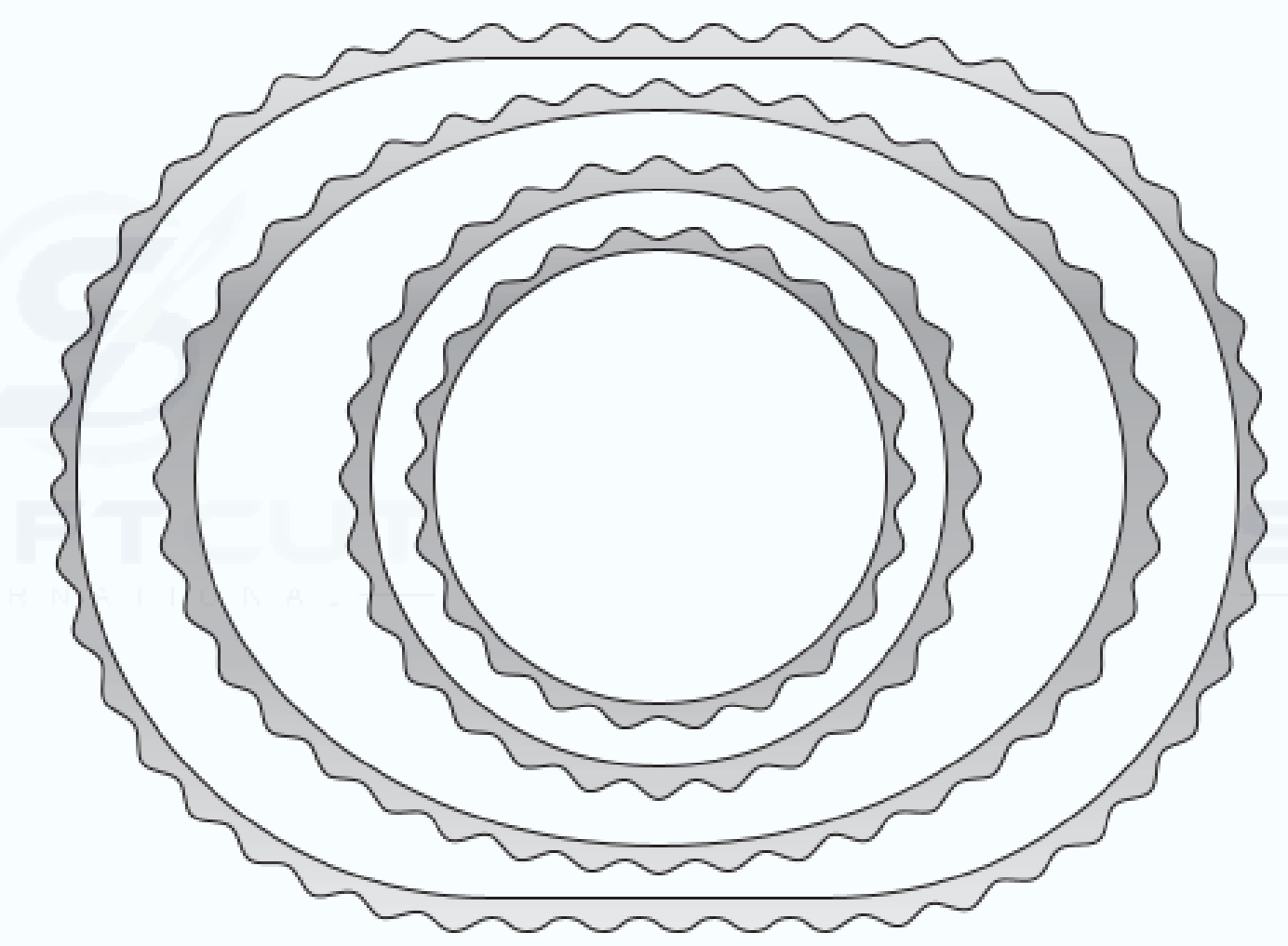

Turner Warwick Needleholder with Tungsten Carbide Jaws

Curvedshankwith one short bow

SH-5835	230mm long
SH-5835A	200mm long

Blade A



SC-GI/522-A	Blade only - 19mm x 76mm
-------------	--------------------------

Blade B

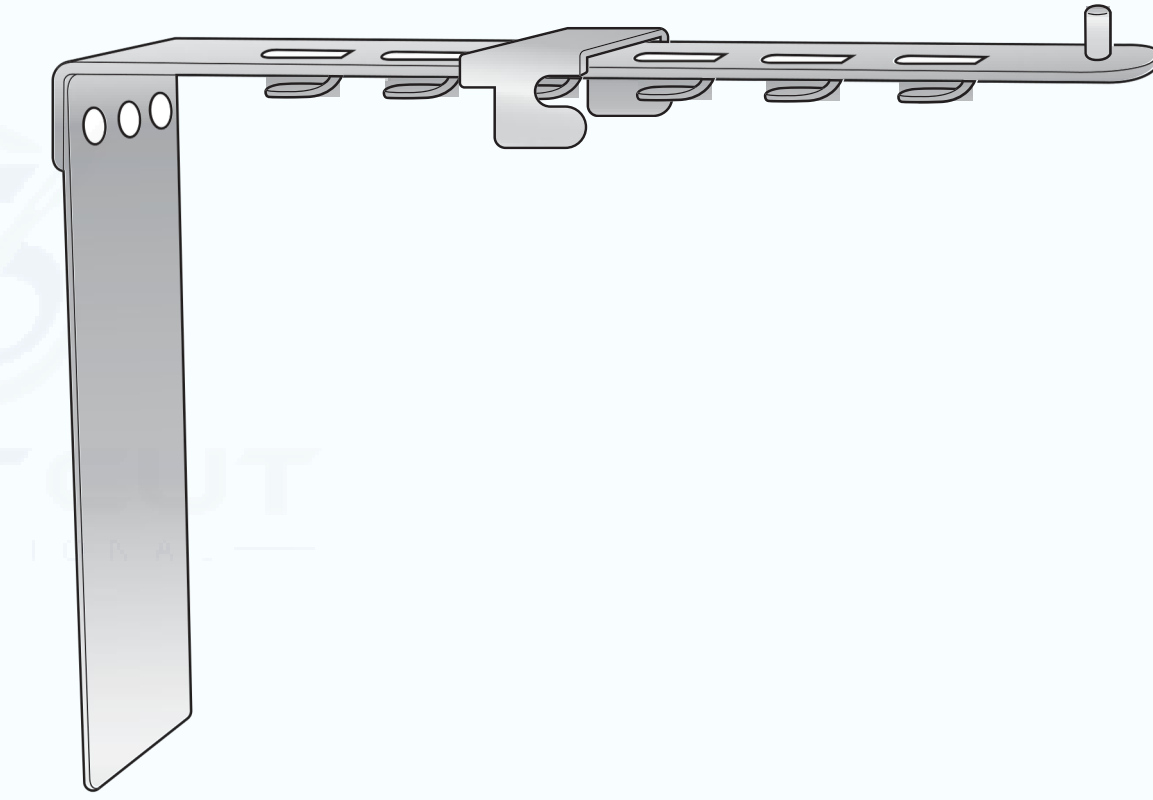

SC-GI/522-B	Blade only - 38mm x 102mm
-------------	---------------------------

Blade C

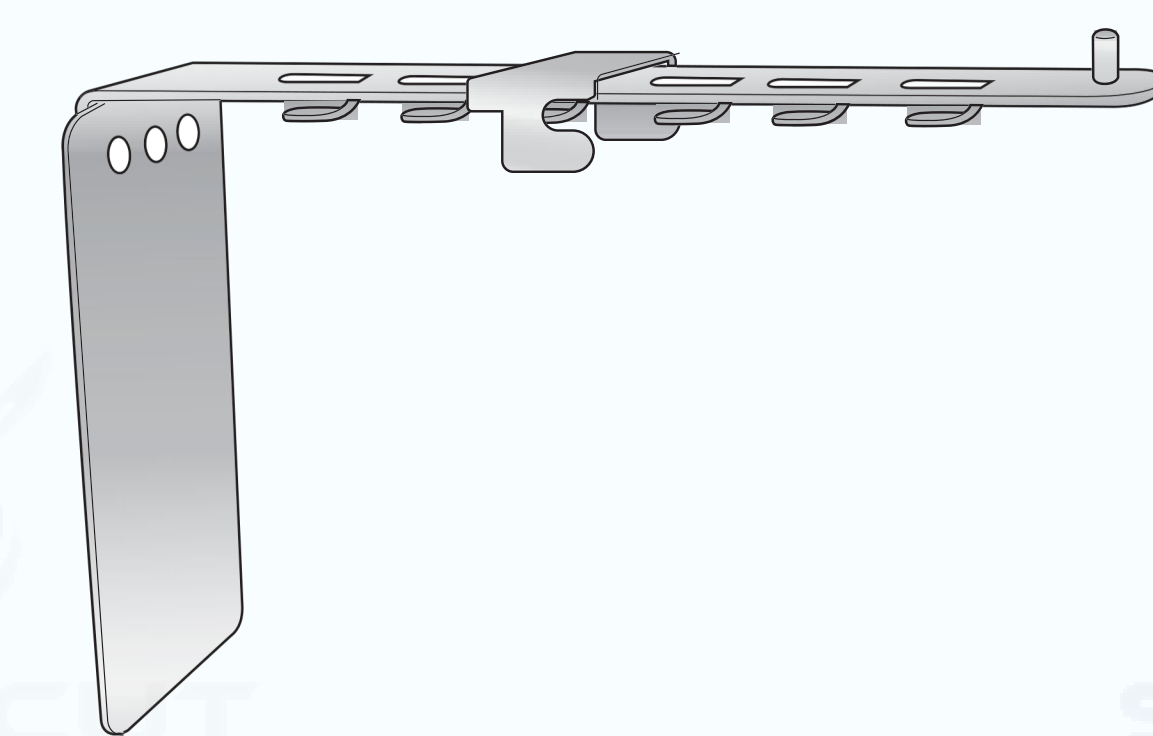

SC-GI/522-C	Blade only - 57mm x 89mm
-------------	--------------------------

Blade D

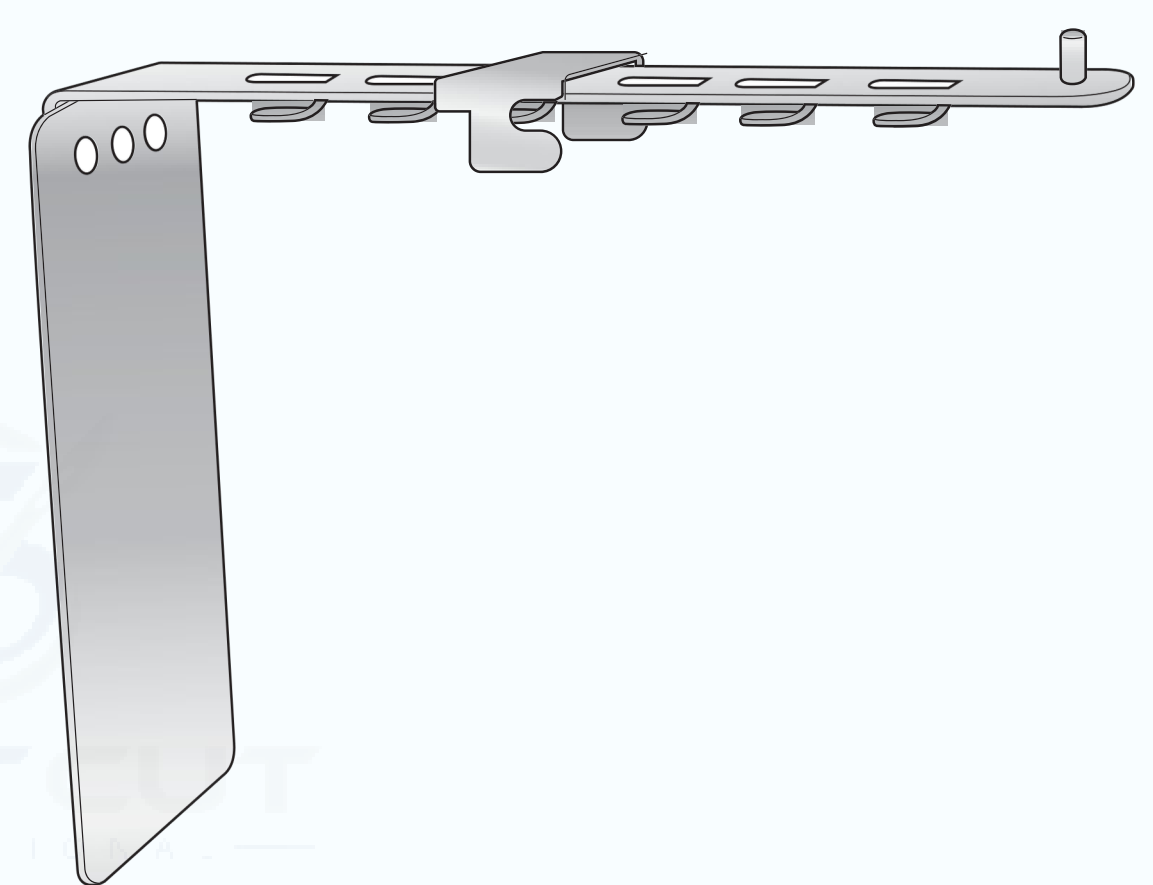

SC-GI/522-D	Blade only - 57mm x 114mm
-------------	---------------------------

Blade E

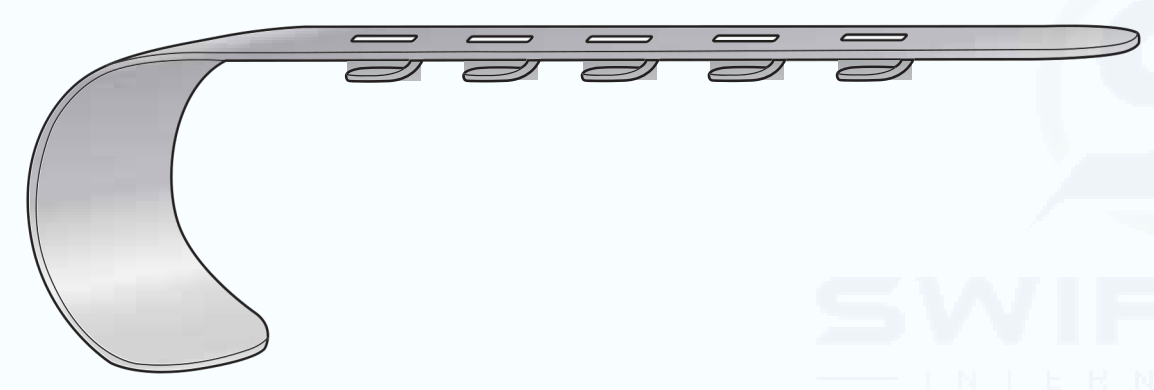

SC-GI/522-E	Blade only - curved stainless steel blade 51mm x 38mm
-------------	---

Blade F

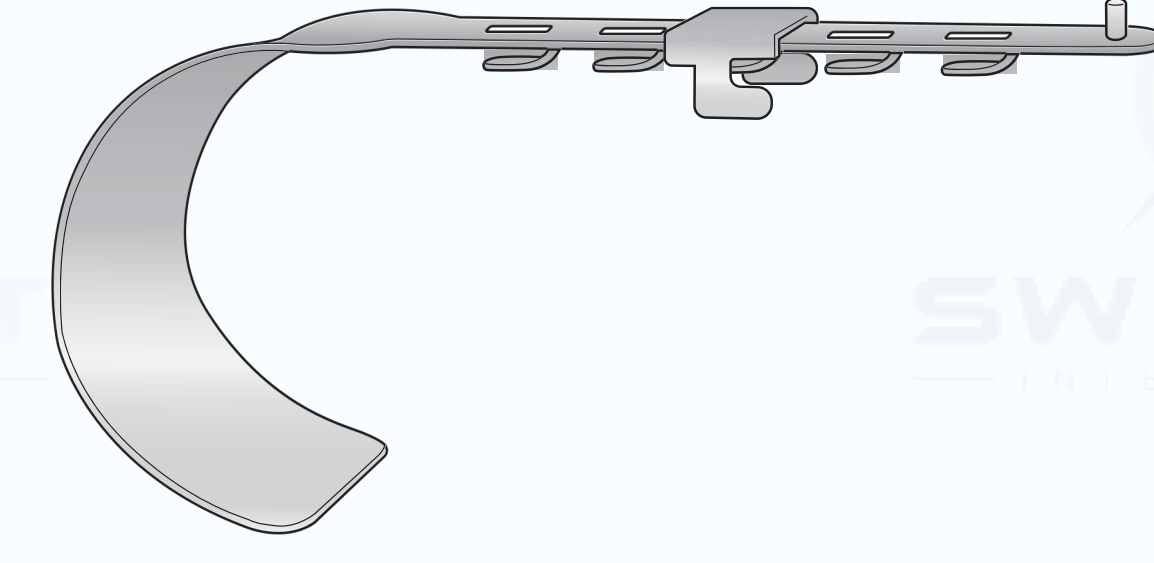

SC-GI/522-F	Blade only - curved stainless steel blade 76mm x 60mm
-------------	---

Blade G

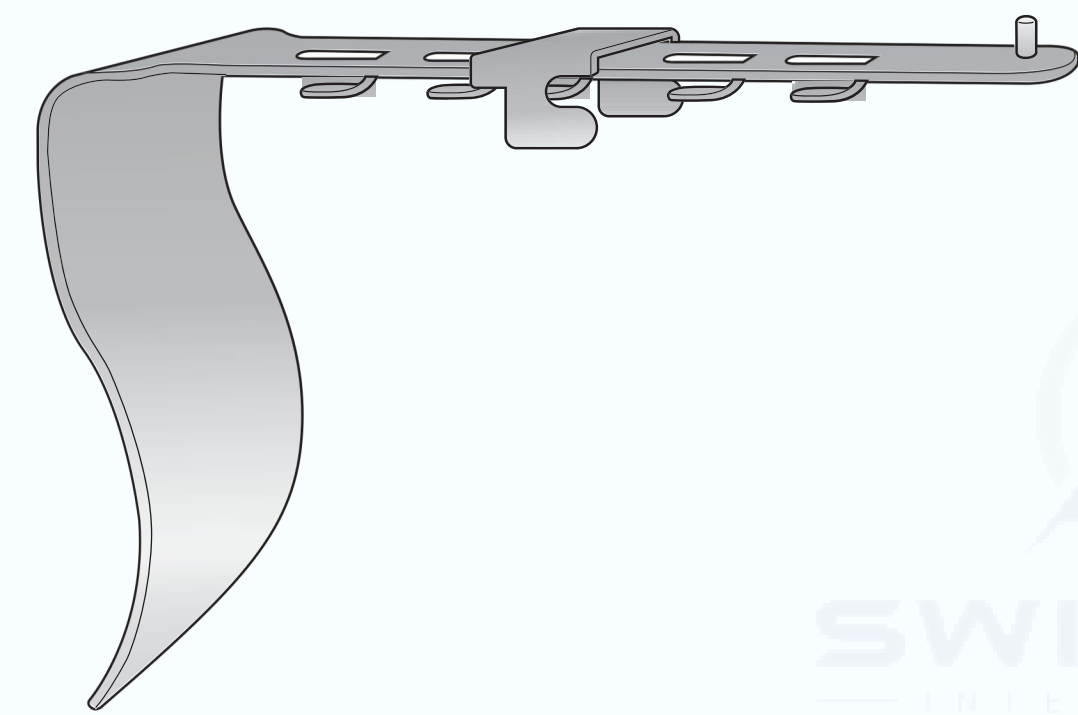

SC-GI/522-G	Blade only - flat stainless steel blade 89mm x 60mm
-------------	---

Blade J

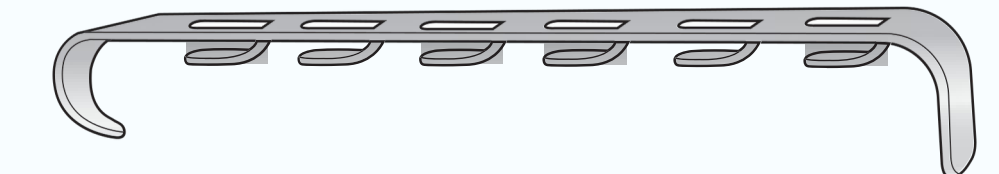

SC-GI/522-J	Blade only - single hook, 13mm deep
-------------	-------------------------------------

Blade K

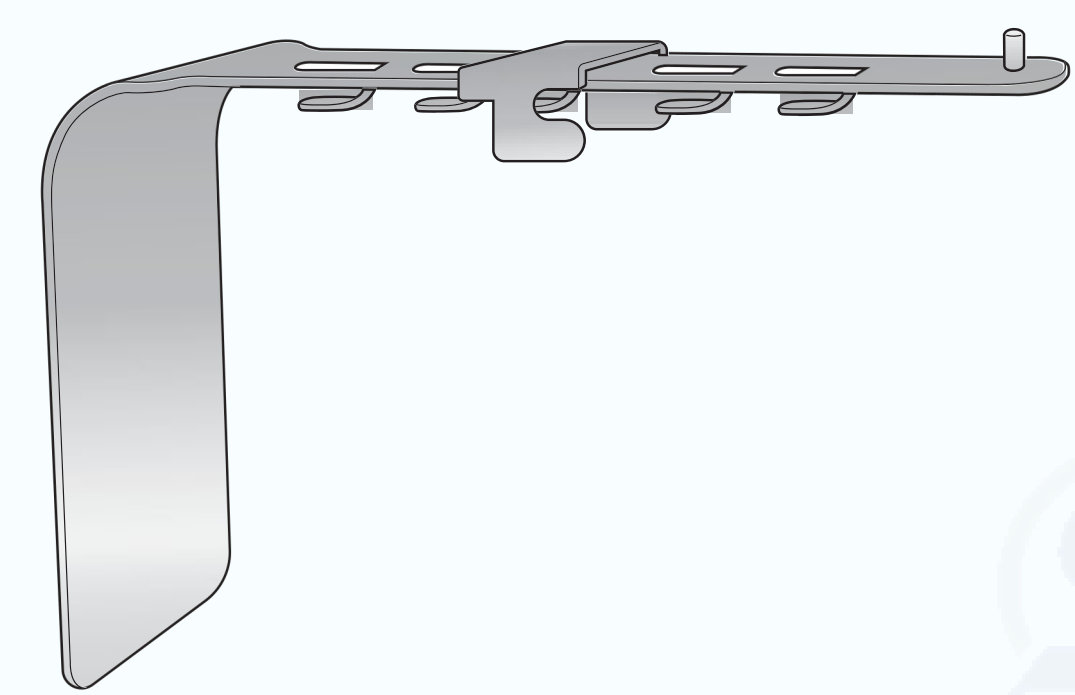

SC-GI/522-K	Blade only - flat with clip 55mm x 90mm
-------------	---

Blade L

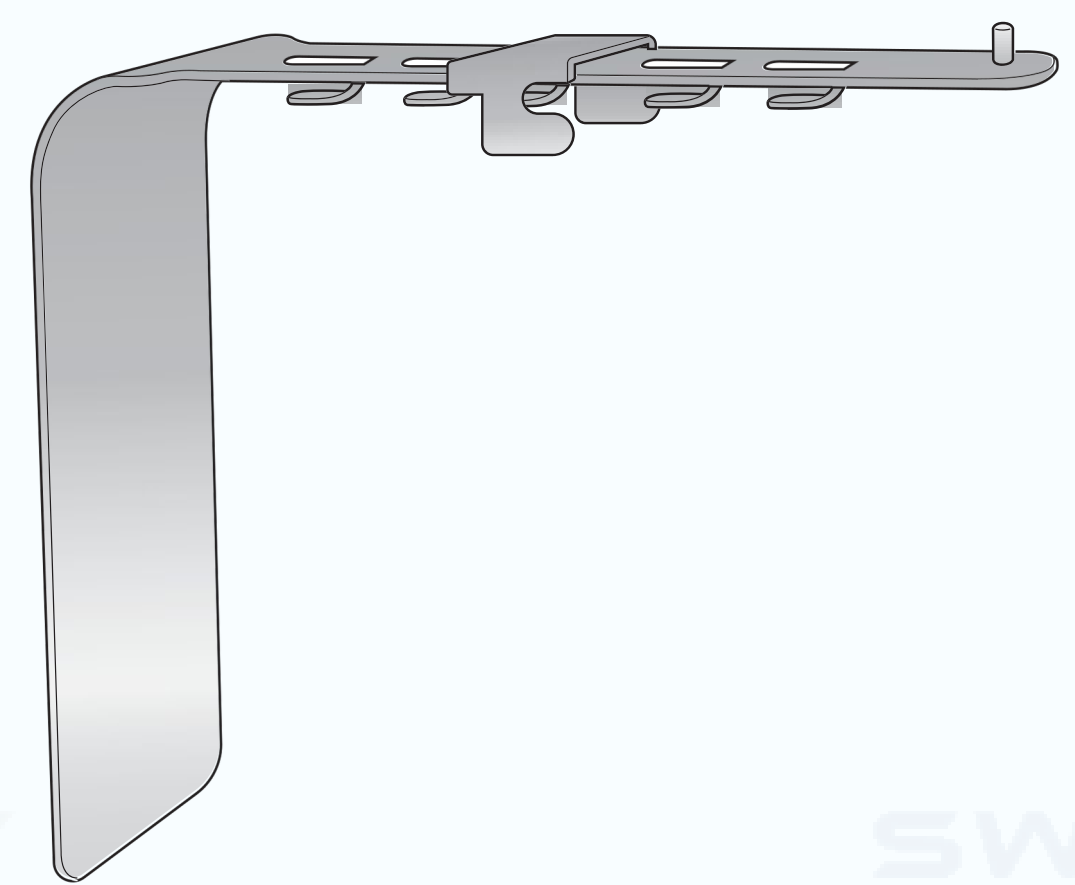

SC-GI/522-L	Blade only - flat with clip 55mm x 120mm
-------------	--

Collin Retractor

110mm fully open, 235mm long

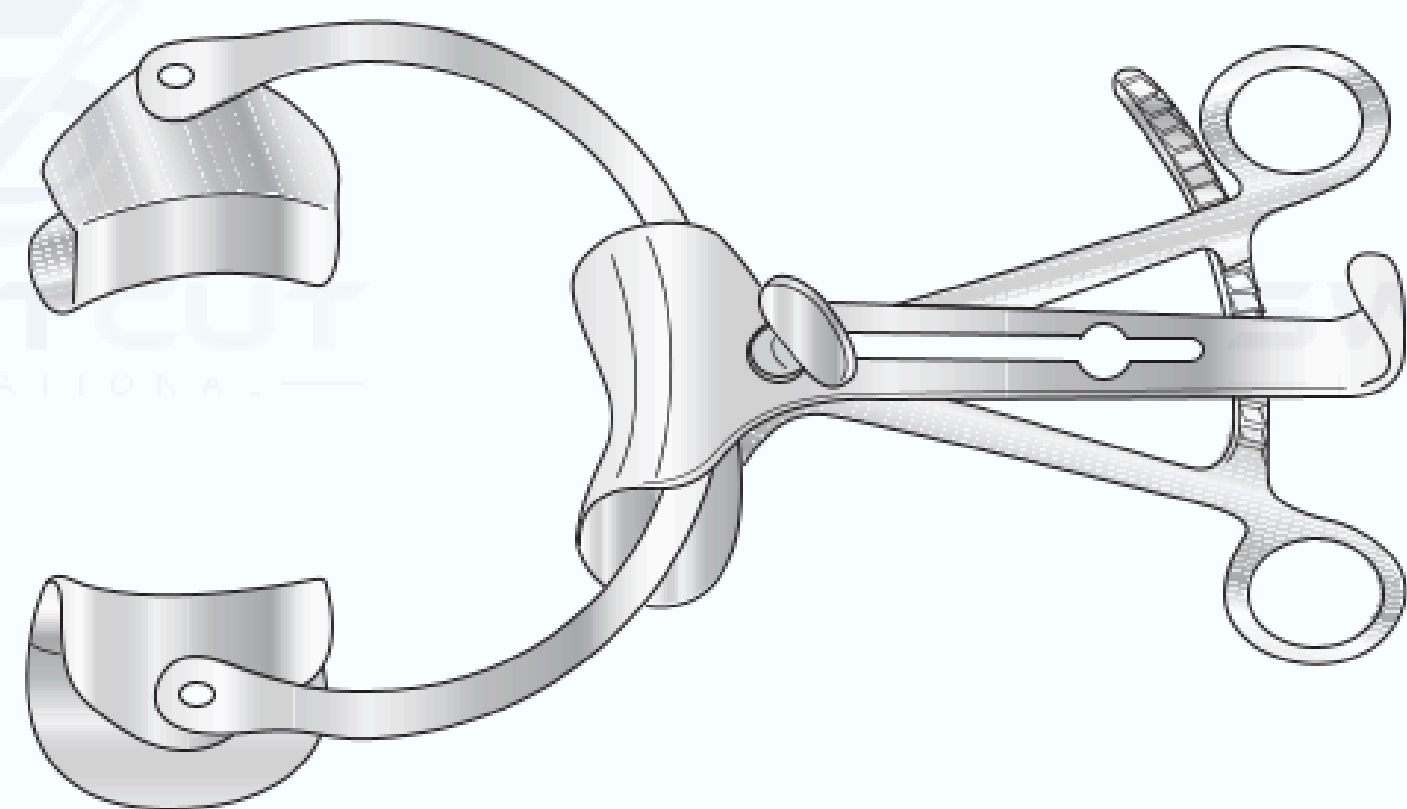

SC-GI/322 Complete with centre blade 55x40mm and one pair of blades 38mmx60mm
 SC-GI/322a Without centre blade

Gelpi Retractor

Selfretaining

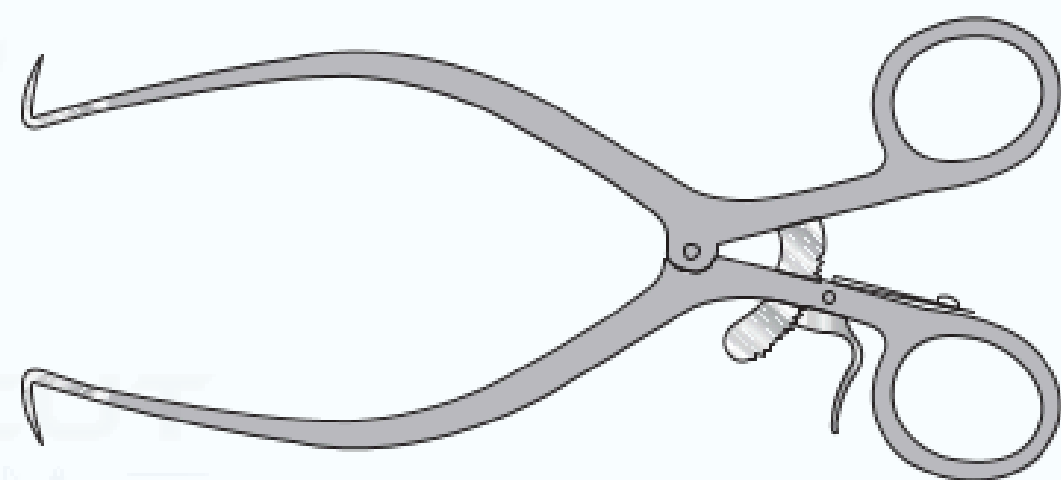

SCGY/013a 140mmlong
 SC-GY/013b 178mmlong

Joll Thyroid Retractor

Self retaining, with lock-innate

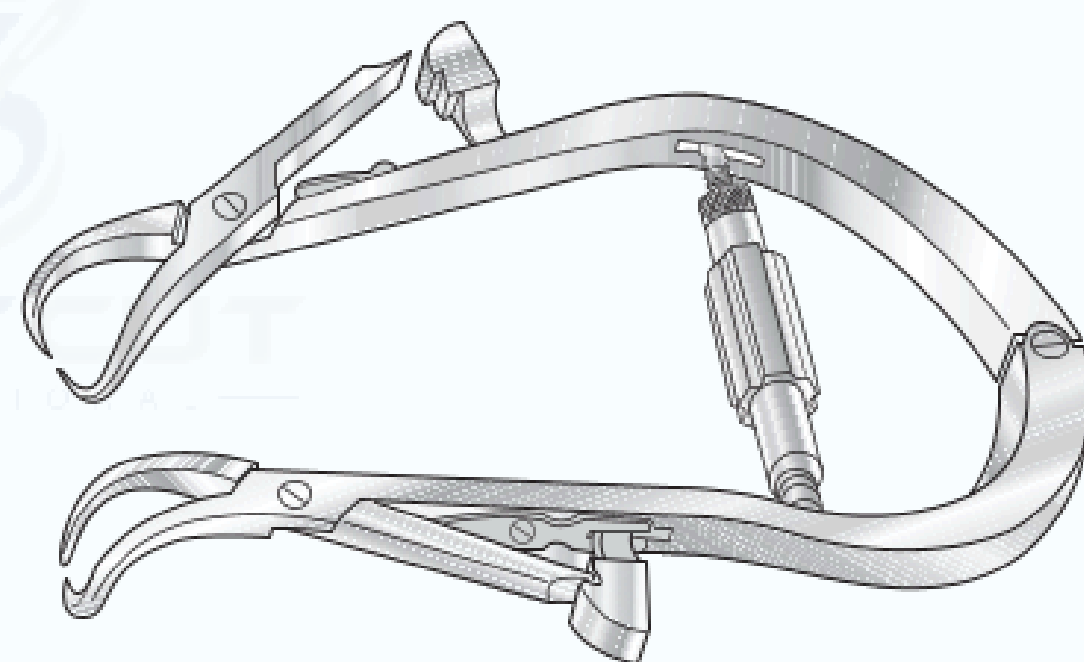

SC-GI/363 152mmlong

Gossett Abdominal Retractor

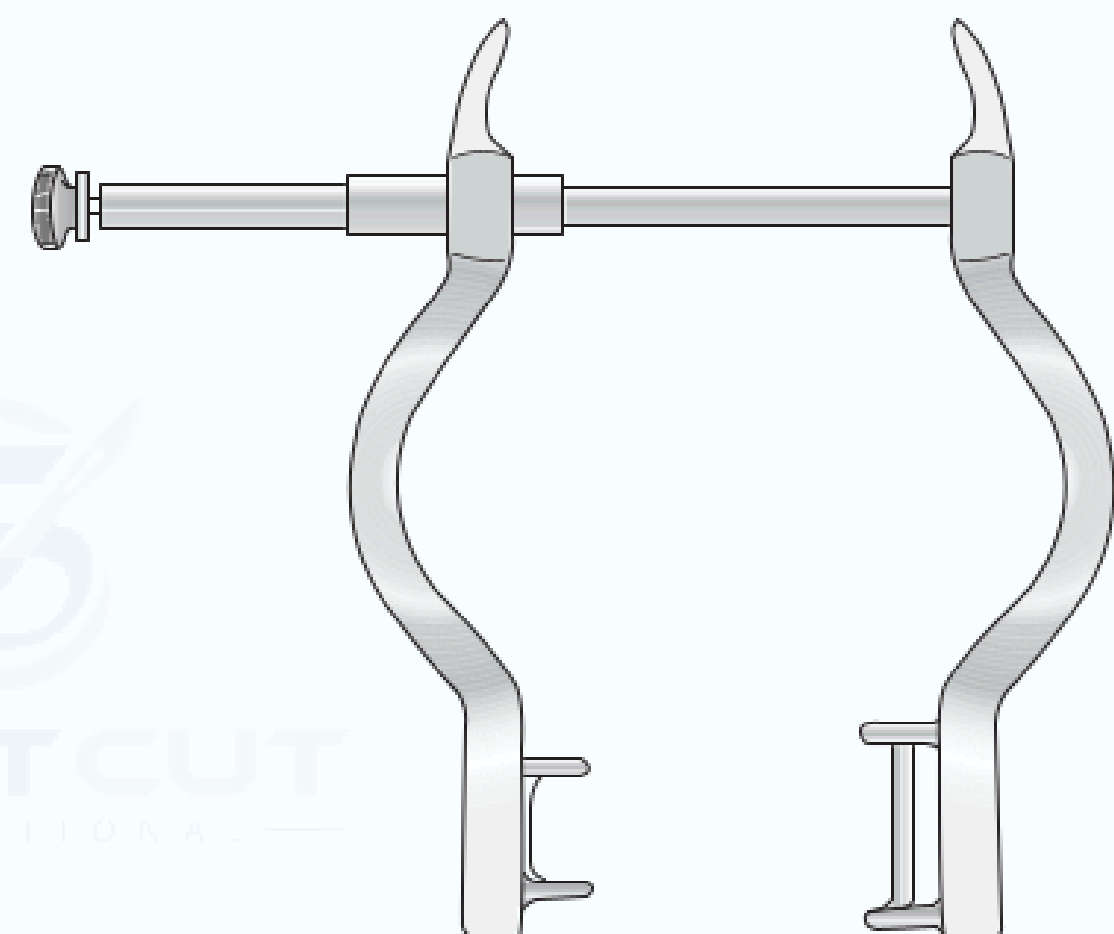

SC-GI/303 Large,fully open185mmlong
 SC-GI/304 Small,fully open95mmlong

Bowlby Dilator

Curved

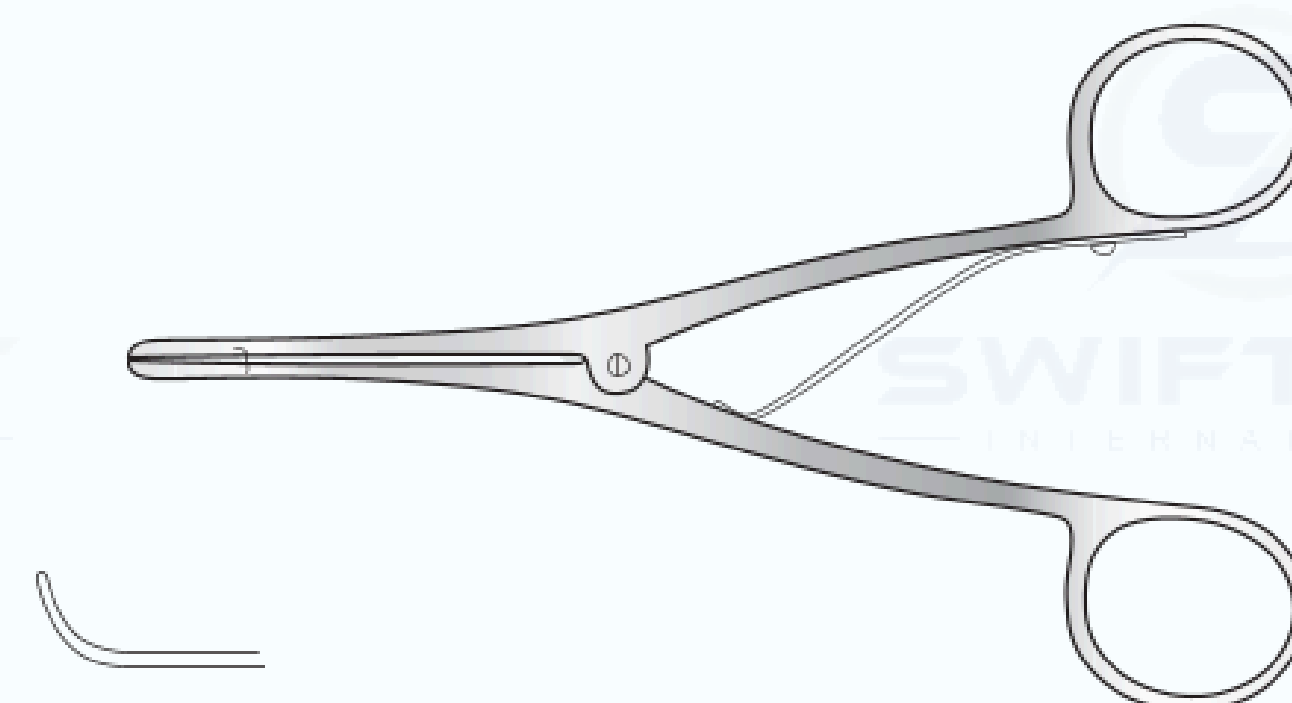

SC-GI/495 145mmlong

Irwin Retractor

Self retaining, with cam rack, 4 x 4 teeth

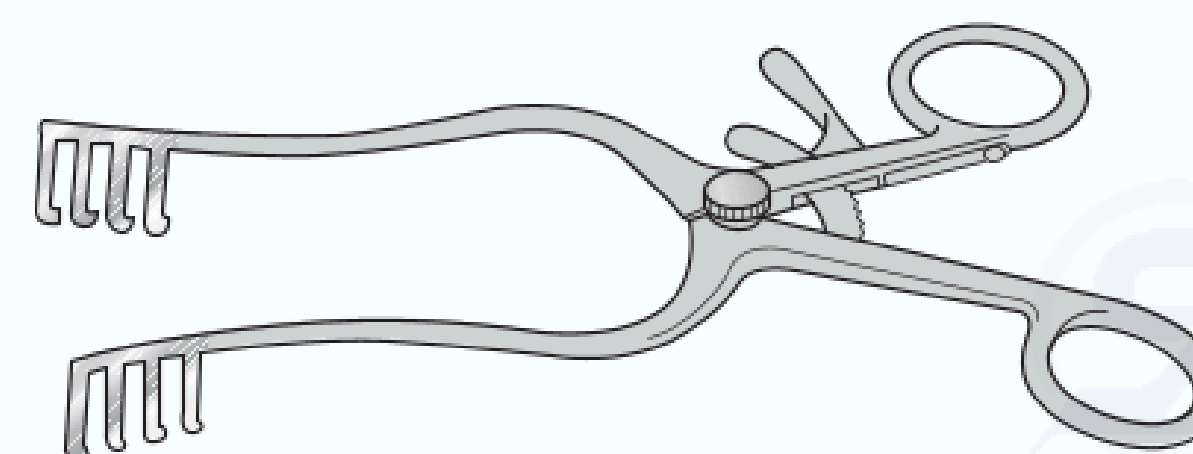

SC-GI/324 178mmlong

Travers Retractor

Self retaining with internal rack, 210mm long

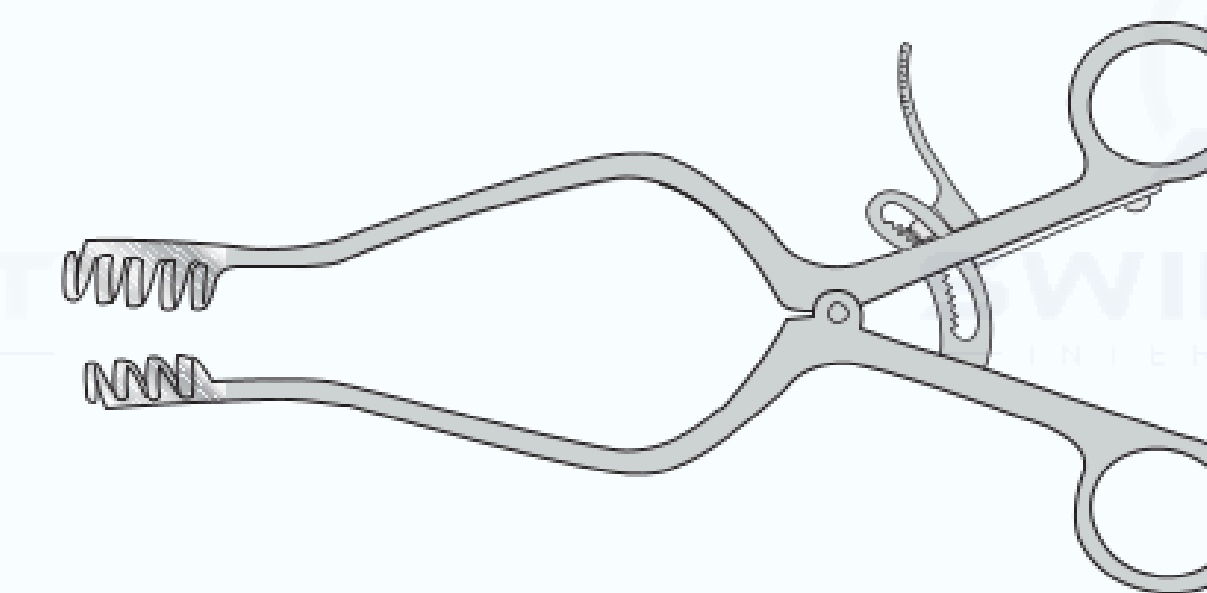

SC-GI/323 4x5teeth,95mmfullyopen

West Retractor

Self retaining, 140mm long

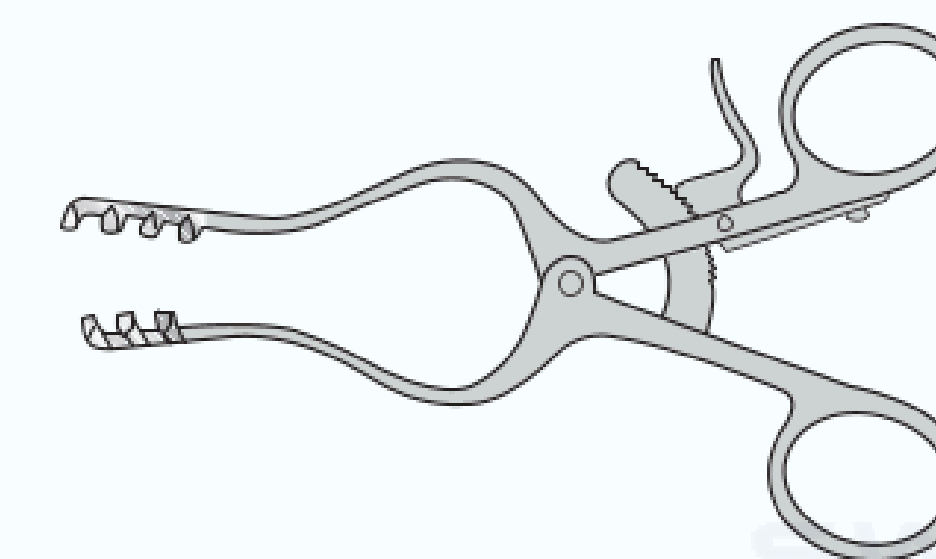

SC-GI/326 3x4teeth,60mmfullyopen
 SC-GI/326cr 3x4teeth,60mmfullyopen,withcam rack

Pozzi Abdominal Retractors

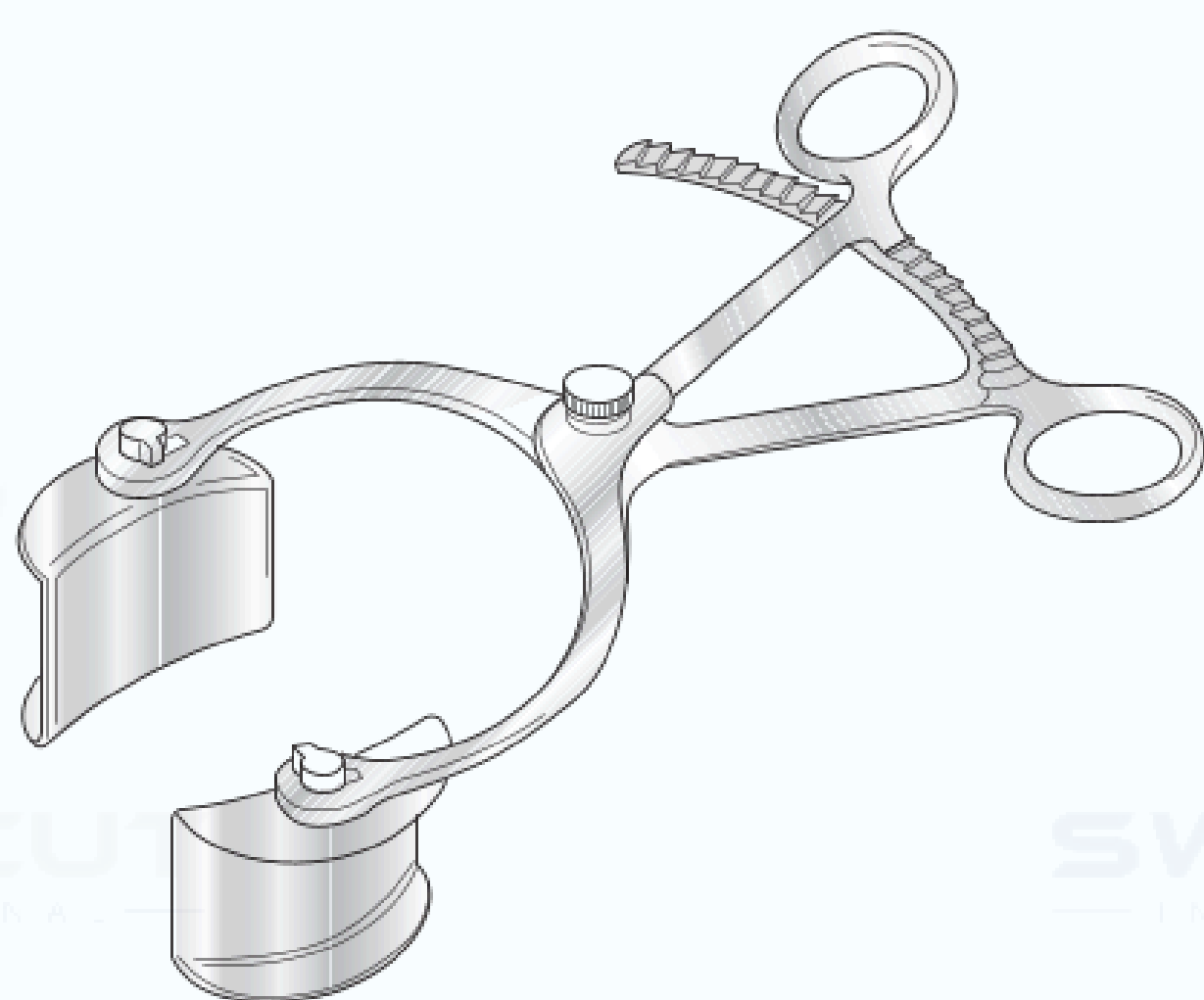

SC-GI/370 Swivel blades: 38x 60mm, bivalve,254mm long

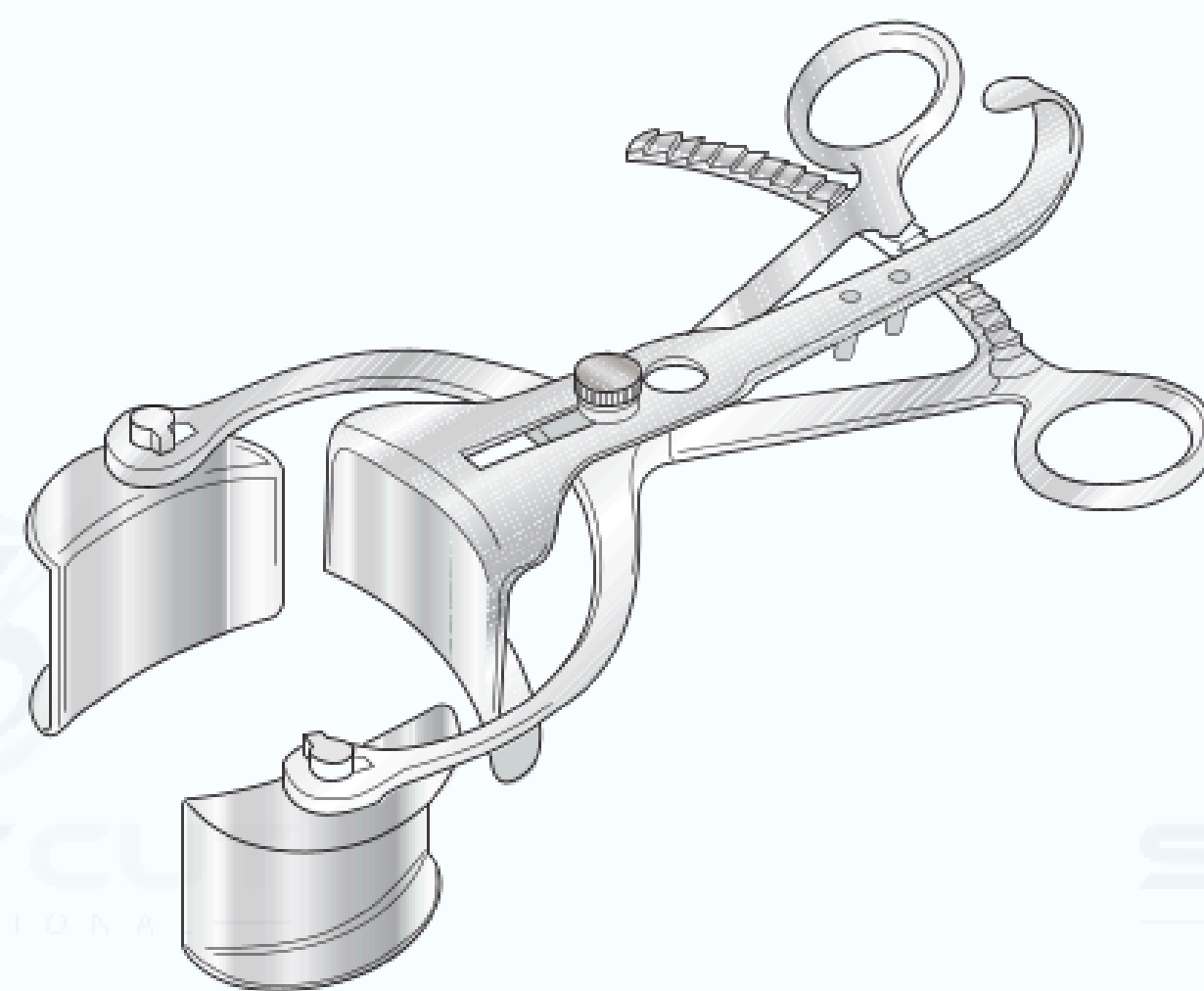

SC-GI/371 Swivel blades: 38x 59mm, trivalve, 203mm long

Norfolk and Norwich Retractor

4 x 5 teeth 50mm blades x 223mm long

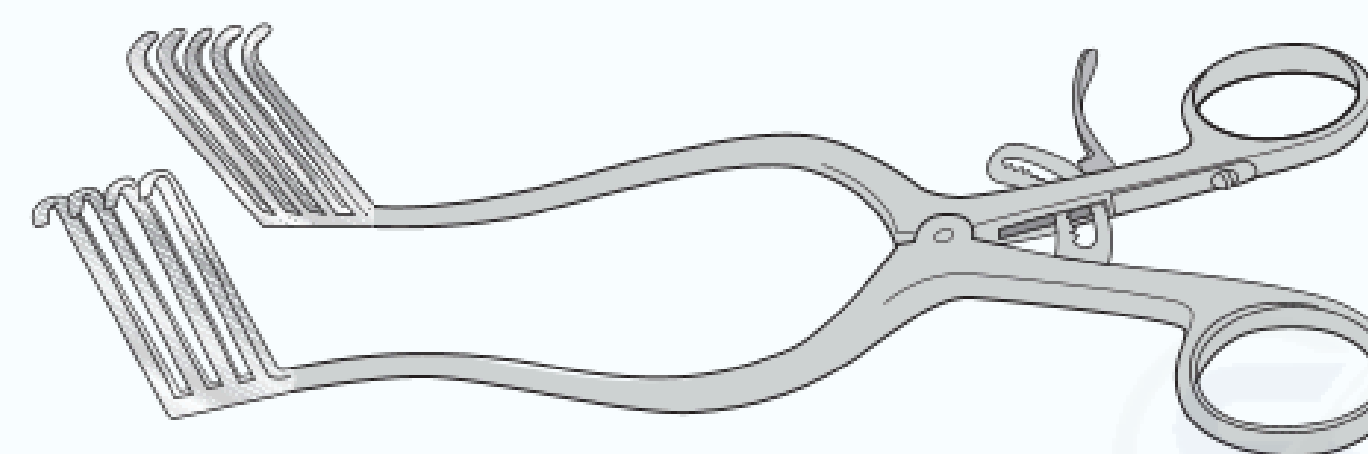

SC-GI/325 Standard rack

Weitlander Retractor

3-4 teeth

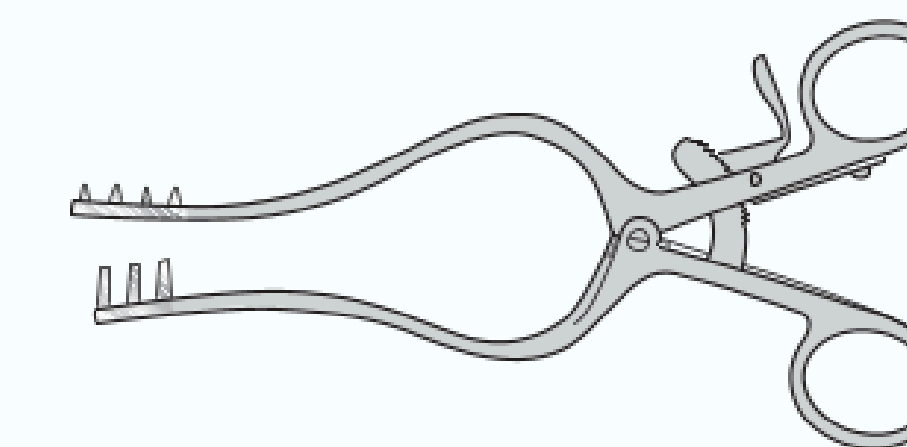

135mm long

SCGI/496 Blunt
 SC-GI/496a Sharp
 SC-GI/496b Sharp,2-3teeth
 SC-GI/496c Blunt,2-3teeth

165mm long

SC-GI/497 Blunt
 SC-GI/497a Sharp

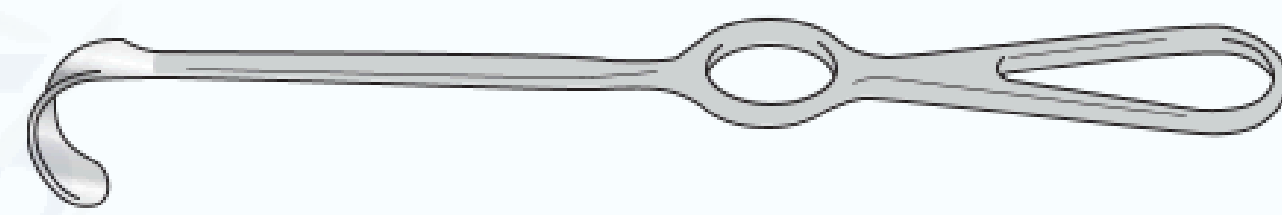
Kocher Retractor

230mm long

SC-GI/378	36 x 20mm blade
-----------	-----------------

250mm long

SC-GI/378a	67 x 25mm blade
SC-GI/378b	80 x 42mm blade
SC-GI/378c	80 x 50mm blade
SC-GI/378d	80 x 60mm blade

Kocher Langenbeck Retractor

215 mm long

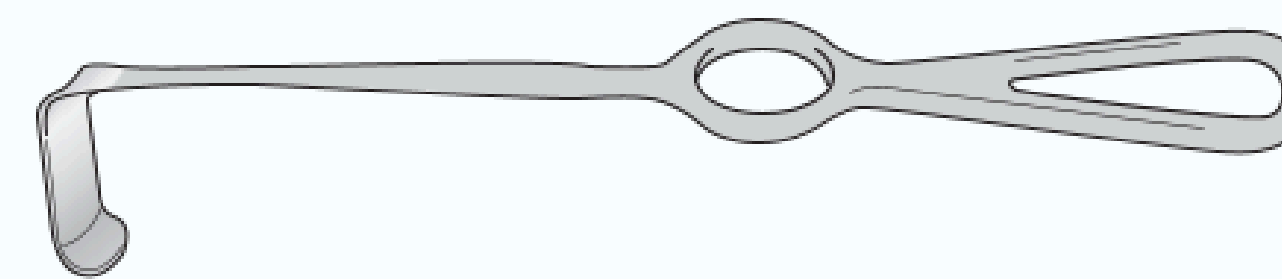

SCGI/336sp	25 x 6mm blade
SC-GI/379a	35 x 8mm blade
SC-GI/379b	35 x 11mm blade
SC-GI/379c	35 x 15mm blade
SC-GI/357sp	41 x 11mm blade

SCTHO/cutsp015	55 x 11mm blade
SC-GI/379d	70 x 15mm blade
SC-GI/379e	80 x 12mm blade
SC-GI/379f	80 x 16mm blade

Langenbeck Retractor

Single ended

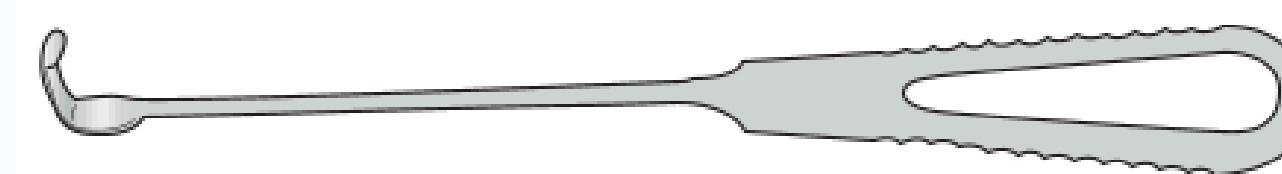

SCGI/336	Blade 22mm x 6mm
SC-GI/337	Blade 45mm x 13mm
SC-GI/337a	Blade 65mm x 13mm
SC-GI/338a	Blade 75mm x 25mm
SC-GI/338a1	Blade 65mm x 25mm

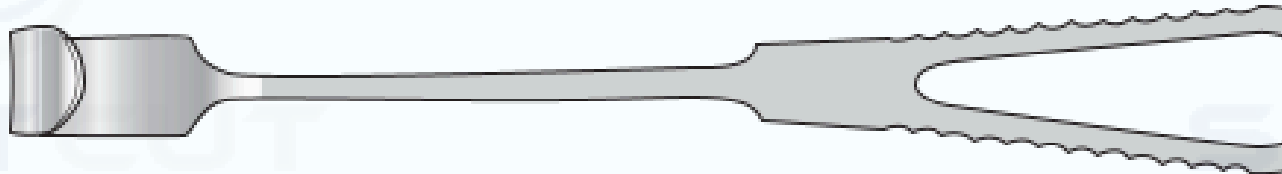
Landon Retractor

SC-GI/494	230mm
-----------	-------

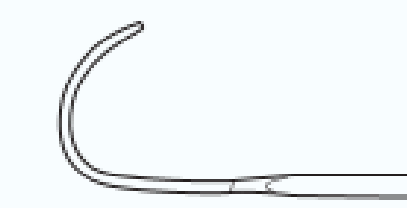
**Canny Ryall Navy Retractor**

Double-ended, with one single hook blade 5mm wide, and one fenestrated blade

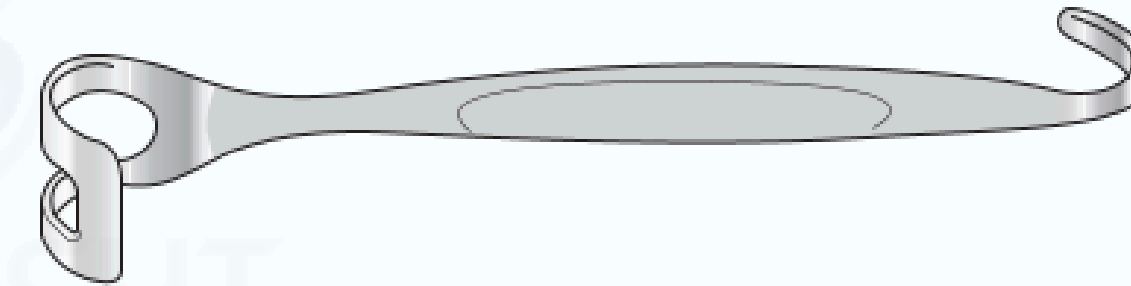

SCGI/343	Fenestrated blade 16mm wide, 190mm long
SC-GI/343a	Fenestrated blade 19mm wide, 190mm long
SC-GI/343b	Fenestrated blade 25mm wide, 220mm long
SC-GI/343c	Fenestrated blade 30mm wide, 220mm long

Canny Ryall Army Retractor

Double prong, 13mm wide, 165mm long

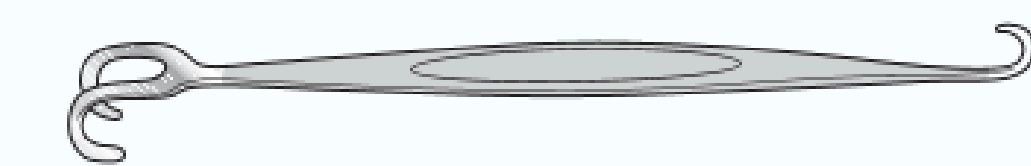

SC-GI/342	Large, 19mm wide
SC-GI/342a	Small, 11mm wide

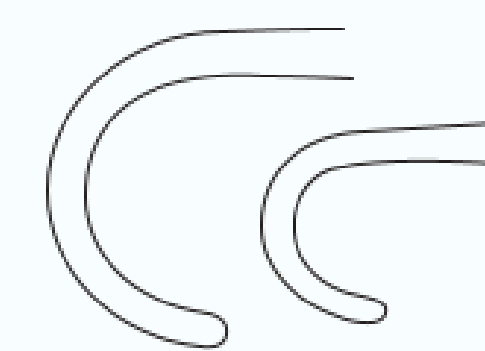
**Czerny Retractor**

Double ended

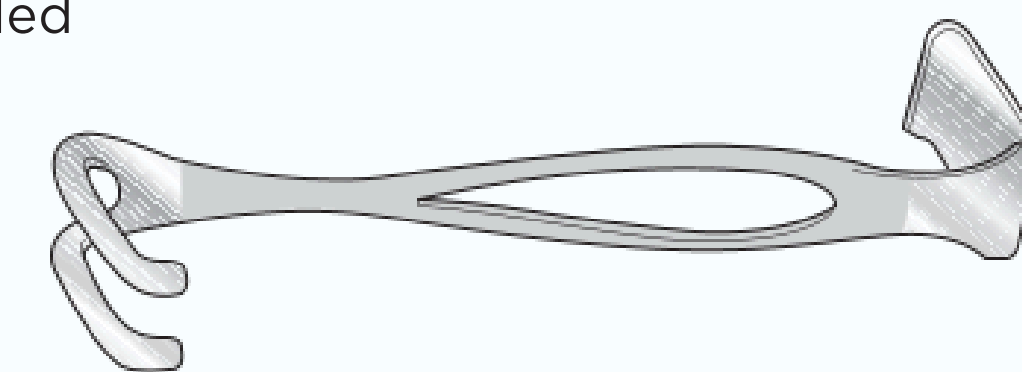

SC-GI/341	171mm long
-----------	------------

Lane Retractor

Double ended blade, 229mm long

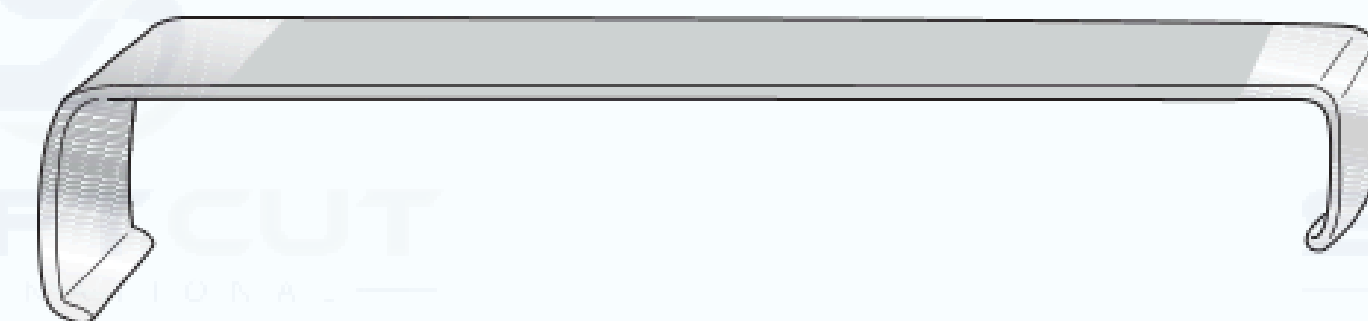

SC-GI/339	13mm x 19mm wide
SC-GI/340	25mm x 32mm wide

Morris Retractor

Single blade, 229mm long

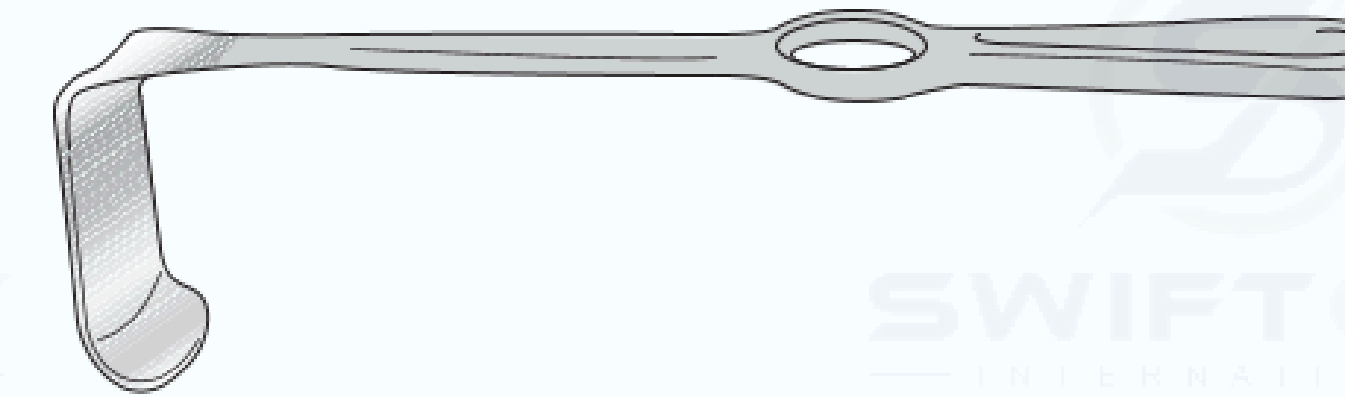

SC-GI/330	38 x 51mm
SC-GI/331	51 x 51mm
SC-GI/332	64 x 51mm

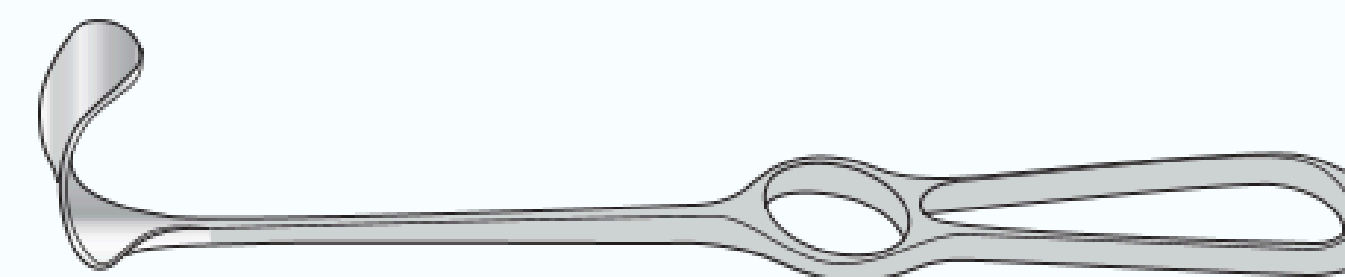
Moynihan Retractor

SC-GI/462	Single ended, blade 13 x 22mm, 215mm long
-----------	---

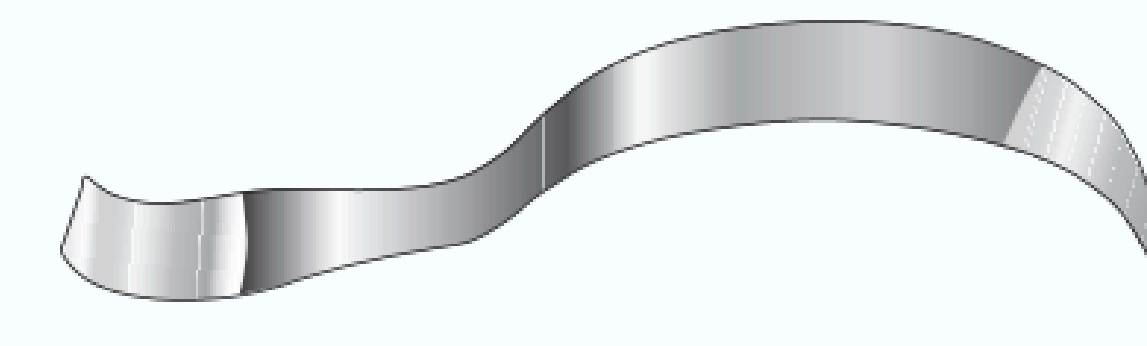
Elliot (Modified Deaver) Retractor

SC-GI/308M	With flat handle
------------	------------------

Deaver Abdominal Retractors

With round handles

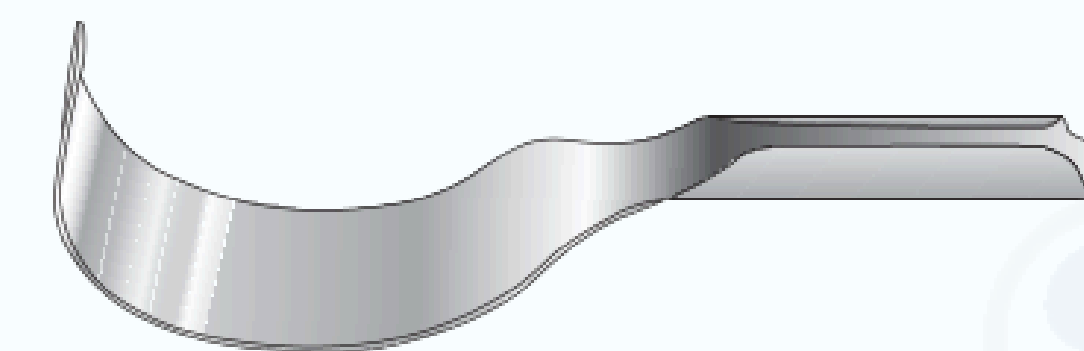

SC-GI/312	Set of 5, 305mm overall length
SC-GI/313	25mm wide
SC-GI/314	25mm wide
SC-GI/315	38mm wide
SC-GI/316	51mm wide
SC-GI/317	76mm wide

Morris Retractor

Double ended, 216 mm long

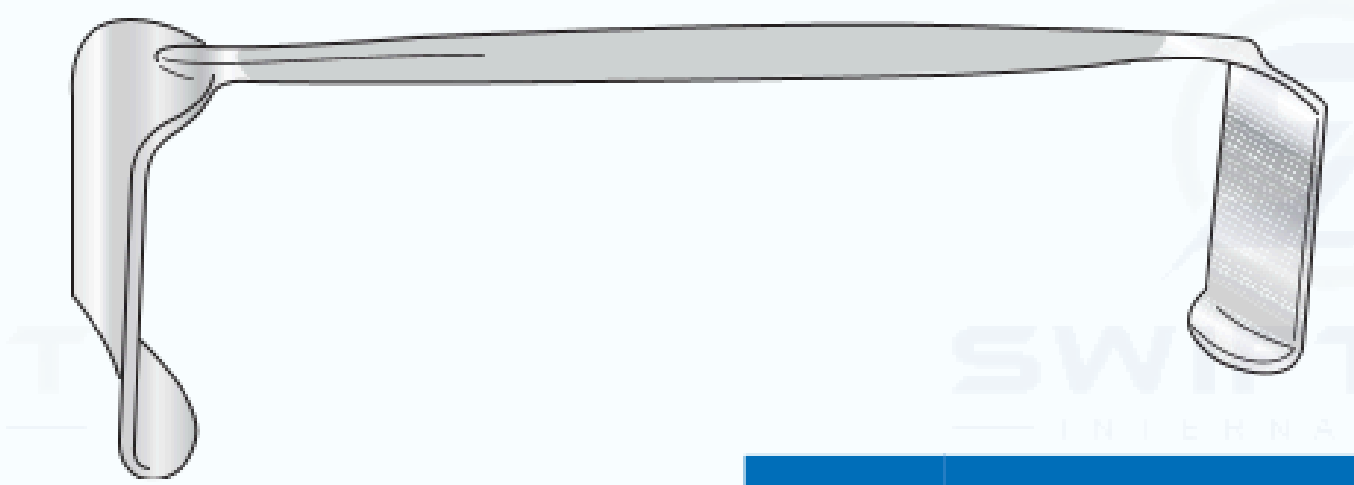

SCGI/327	32 x 51mm and 38 x 51mm
SC-GI/328	44 x 51mm and 51 x 51mm
SC-GI/329	64 x 51mm and 38 x 51mm

Deaver Abdominal Retractors

SC-GI/306	Set of 5, 315mm overall length
SC-GI/307	25mm wide
SC-GI/308	25mm wide
SC-GI/309	38mm wide
SC-GI/310	51mm wide
SC-GI/311	76mm wide

Dyball and Lock Retractor

For liver



SC-GI/335	64 x 144mm, 241mm long
-----------	------------------------

OTHER SIZES AVAILABLE - PRICE ON APPLICATION

Kelly Retractor Blade

267 mm long



SCGI/333	38 x 191mm
SC-GI/334	57 x 191mm

Durham Retractor

With fenestrated blade, 216mm long

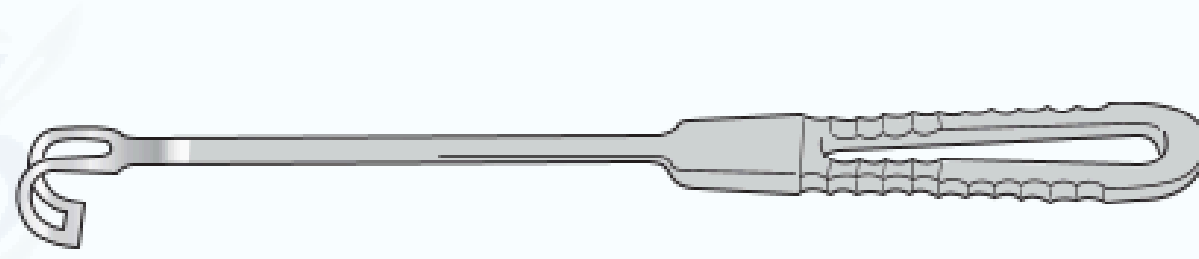

SC-GI/300	10mm wide
SC-GI/301	14mm wide
SC-GI/302	20mm wide

Ballance (Volkman) Retractor

203mm long



Sharp

SCGI/463	1 prong
SC-GI/463a	2 prong
SC-GI/463b	3 prong
SC-GI/463c	4 prong
SC-GI/463d	6 prong

Blunt

SCGI/463e	1 prong
SC-GI/463f	2 prong
SC-GI/463g	3 prong
SC-GI/463h	4 prong
SC-GI/463i	6 prong

Volkman Retractor

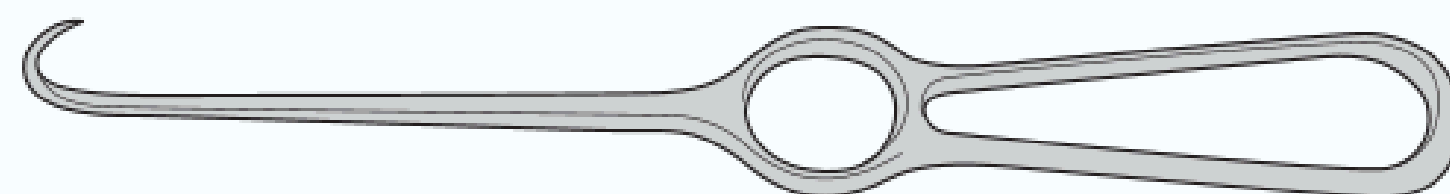

SC-OR/400	Sharp, 220mm long
SC-OR/400a	Blunt, 220mm long
SC-OR/400b	Sharp, 245mm long

Kilner Retractor

Double ended, cat's paw

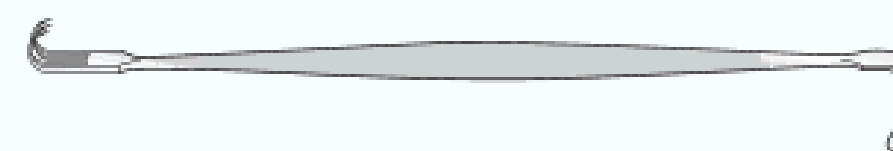

SC-PL/056	152mm long
-----------	------------

Kocher Retractor

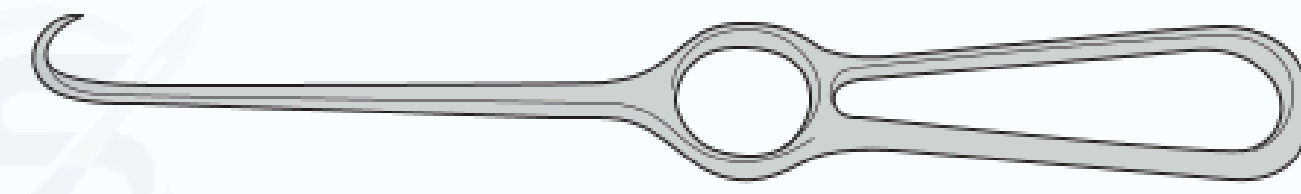

SC-OR/N036c	Sharp, 205mm long
SC-OR/N036	Sharp, 220mm long
SC-OR/N036b	Blunt, 220mm long

Senn-Miller Retractor

170mmlong

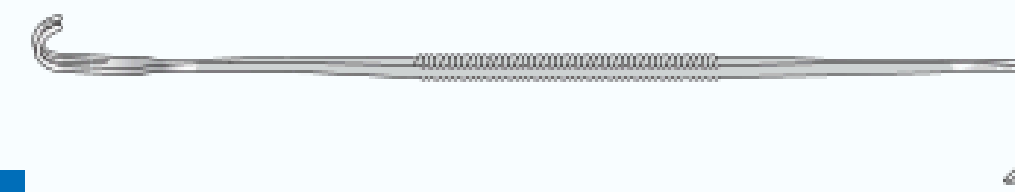

SC-SH/5881	
------------	--

Single Hook Retractor

Sharp



SC-GI/SH5671	152mm long
SC-PL/065b	Half size, fine

Gillies Skin Hook

Solid handle,190mmlong



SC-PL/065a	Standard, fine
SC-PL/065b	Half size, fine

MacDonald Dissector Double Ended Probe, Sinus Silver



SC-GI/285	191mm long
-----------	------------

Brodie Director Probe Ended, Silver Plated

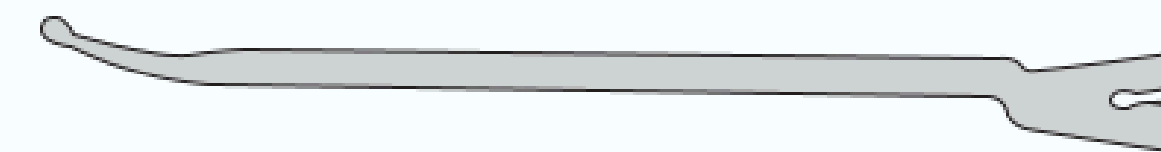

SC-GI/286	165mm long
-----------	------------

Watson Cheyne Dissector

Fine, double-ended, with probe end

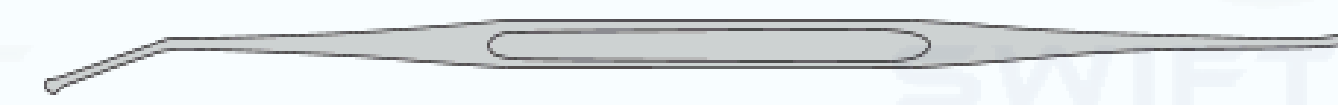

SC-GI/287	127mm long
SC-GI/288	191mm long
SC-GI/288a	230mm long
SC-GI/288b	255mm long

Probe, Malleable Silver Plated



SC-GI/289a	127mm long
SC-GI/289	152mm long
SC-GI/290	178mm long
SC-GI/291	203mm long
SC-GI/292	255mm long
SC-GI/292a	305mm long

Probe, Fish Tail Silver Plated

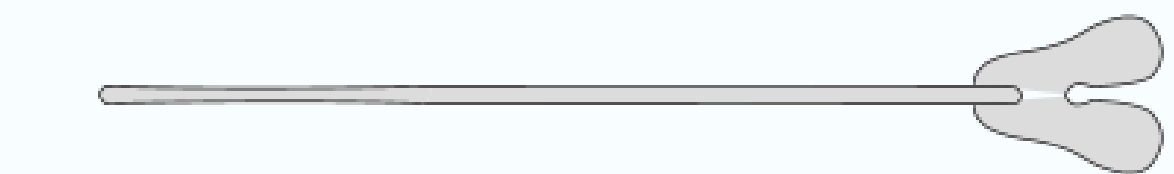

SCGI/293	127mm long
SC-GI/294	152mm long
SC-GI/295	203mm long
SC-GI/296	254mm long

Jobson Horne Probe Dressing (Aural)

With one flat taperedend,serratededgeand one small ring end, stainless steel



SC-GI/297	140mm long
SC-GI/298	178mm long

Aneurysm Needle

Small, for infusions



SC-GI/472a	146mm long
------------	------------

Syme Aneurysm Needle

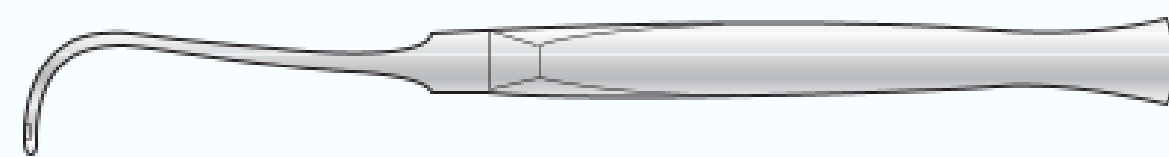

SC-GI/473	165mm long
-----------	------------

Ring Cutter

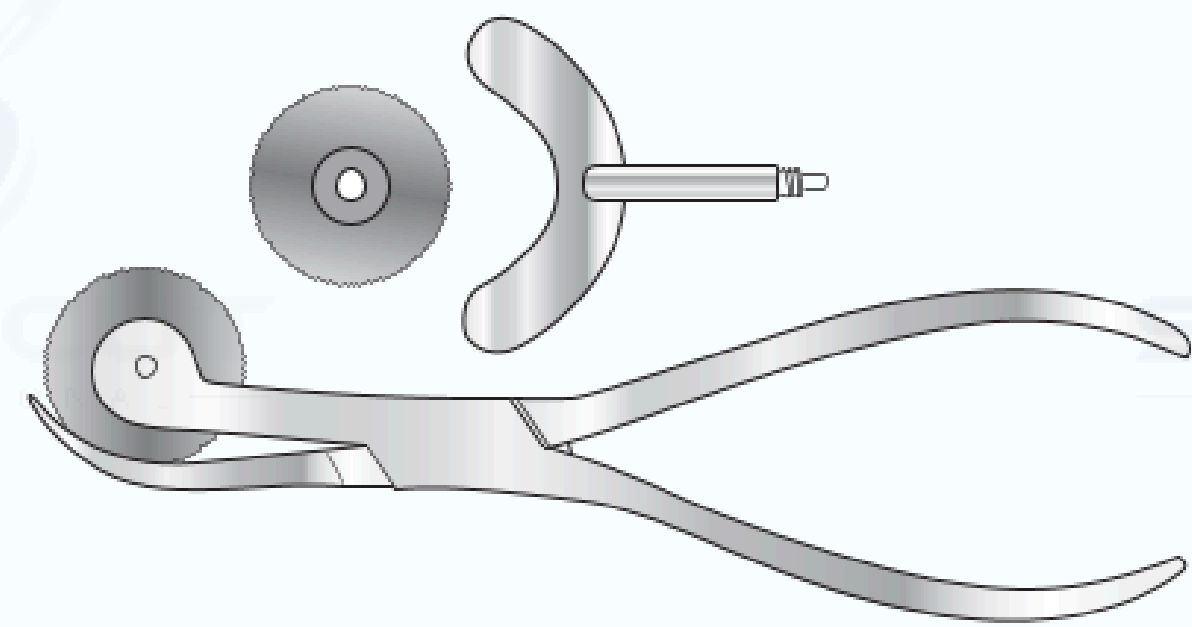

SC-GI/452	Circular saw blade, 165mm long
SC-GI/452a	Spare blade

Mayo Instrument Pin

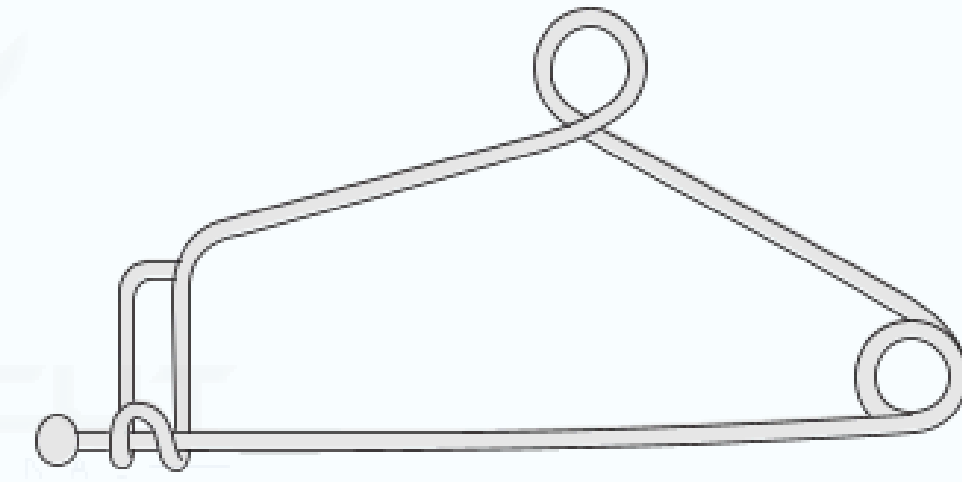

SC-GI/355	102mm long
SC-GI/356	152mm long

Baron Scalpel Handle

130mm long



SC-PM/003	No 3
SC-PM/004	No 4

Scalpel Handle

127mm long



SC-PM/007	No 3
SC-PM/008	No 4
SC-PM/008a	No 4 L
SC-PM/001a	No 7

Kidney Dish

Stainless steel

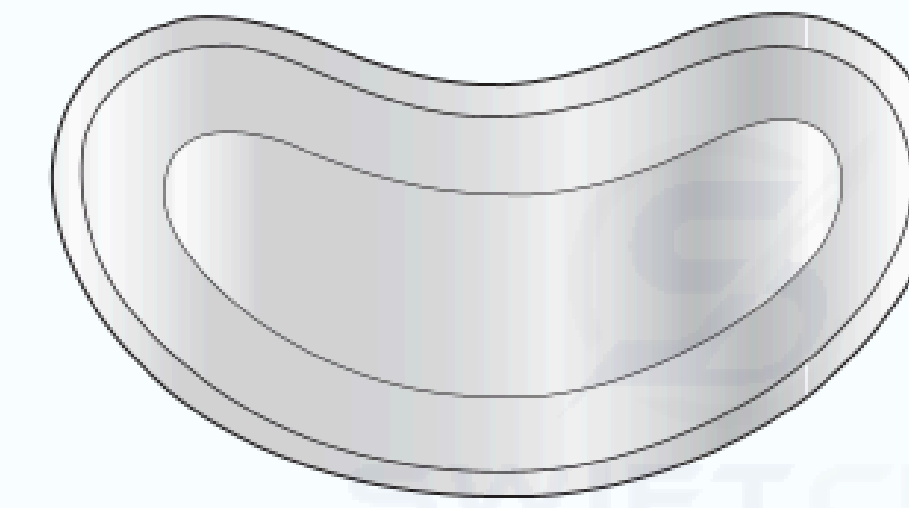

SC-GI/380	152mm
SC-GI/381	203mm
SC-GI/382	254mm
SC-GI/383	305mm

Lotion Bowl

Without lid, stainless steel

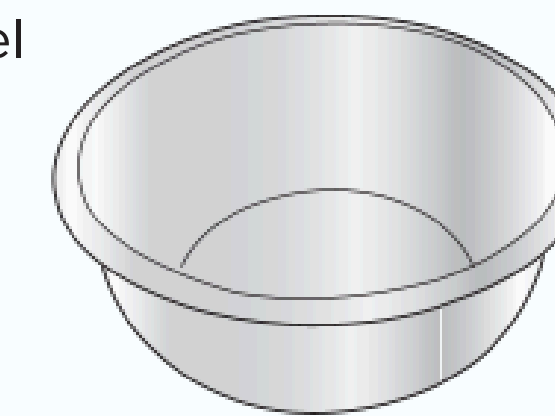

SC-GI/384	102mm
SC-GI/385	152mm
SC-GI/386	203mm
SC-GI/387	254mm
SC-GI/388	305mm

Instrument Tray

Stainless steel

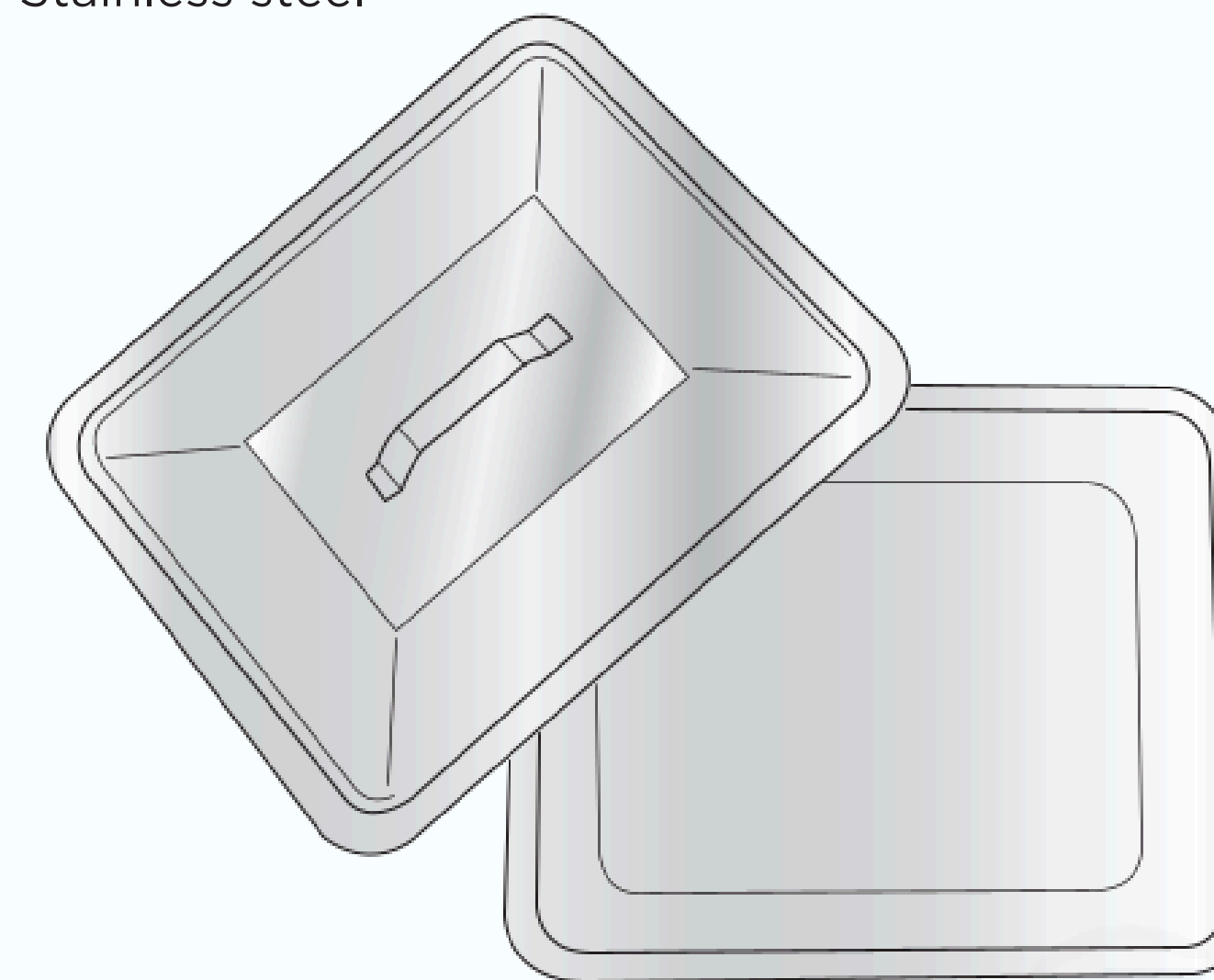

SC-GI/389	254 x 203 x 50mm
SC-GI/390	Lid only for 254 x 203 x 50mm
SC-GI/391	305 x 254 x 50mm
SC-GI/392	Lid only for 305 x 254 x 50mm
SC-GI/393	356 x 305 x 50mm
SC-GI/394	Lid only for 356 x 305 x 50mm

Cheate Jar



SC-GI/397	Stainless steel, 203mm x 50mm
-----------	-------------------------------

Measuring Jug



SC-GI/395	1 litre capacity
-----------	------------------

Petri Dish



SC-SH/002149	100mm, stainless steel, with lid
--------------	----------------------------------

Gallipot

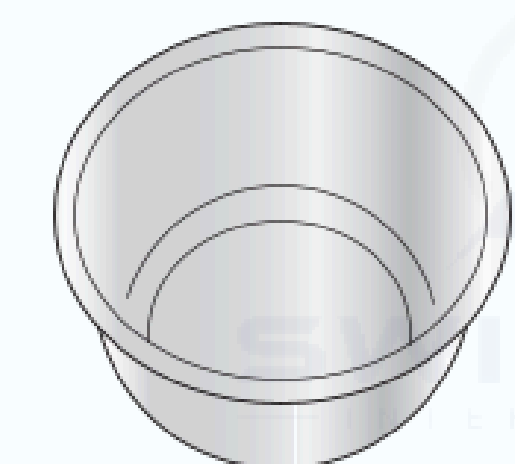

SC-GI/396	Stainless s63mm
-----------	-----------------

Sterilising Baskets

DIN Basket

Wire mesh base with perforated sides and two carrying handles

SC-GI/CO006	230 x 130 x 60mm	SC-GI/CO013	480 x 250 x 70mm
SC-GI/CO007	240 x 130 x 50mm	SC-GI/CO016	480 x 400 x 60mm
SC-GI/CO008	240 x 130 x 60mm	SC-GI/CO017	480 x 480 x 50mm
SC-GI/CO009	240 x 250 x 50mm	SC-GI/CO018	480 x 480 x 60mm
SC-GI/CO010	240 x 250 x 60mm	SC-GI/CO019	500 x 300 x 50mm
SC-GI/CO014	300 x 300 x 50mm	SC-GI/CO020	550 x 430 x 50mm
SC-GI/CO015	350 x 350 x 60mm	SC-GI/CO021	600 x 300 x 60mm
SC-GI/CO011	480 x 250 x 50mm		
SC-GI/CO012	480 x 250 x 60mm		



DIN Basket

Wire mesh basket with two carrying handles

SC-GI/CO022	240 x 250 x 50mm	SC-GI/CO026	480 x 250 x 60mm
SC-GI/CO023	240 x 250 x 60mm	SC-GI/CO027	480 x 250 x 70mm
SC-GI/CO024	240 x 250 x 70mm	SC-GI/CO028	480 x 250 x 100mm
SC-GI/CO031	300 x 300 x 60mm	SC-GI/CO029	480 x 480 x 50mm
SC-GI/CO025	480 x 250 x 50mm	SC-GI/CO030	480 x 480 x 70mm

DIN Basket Lids

For perforated and wire mesh baskets

SC-GI/CO032	240 x 250mm
SC-GI/CO033	300 x 300mm
SC-GI/CO034	480 x 250mm
SC-GI/CO035	480 x 480mm

ENT Basket

Wire mesh base with perforated sides and two carrying handles, supplied with lid

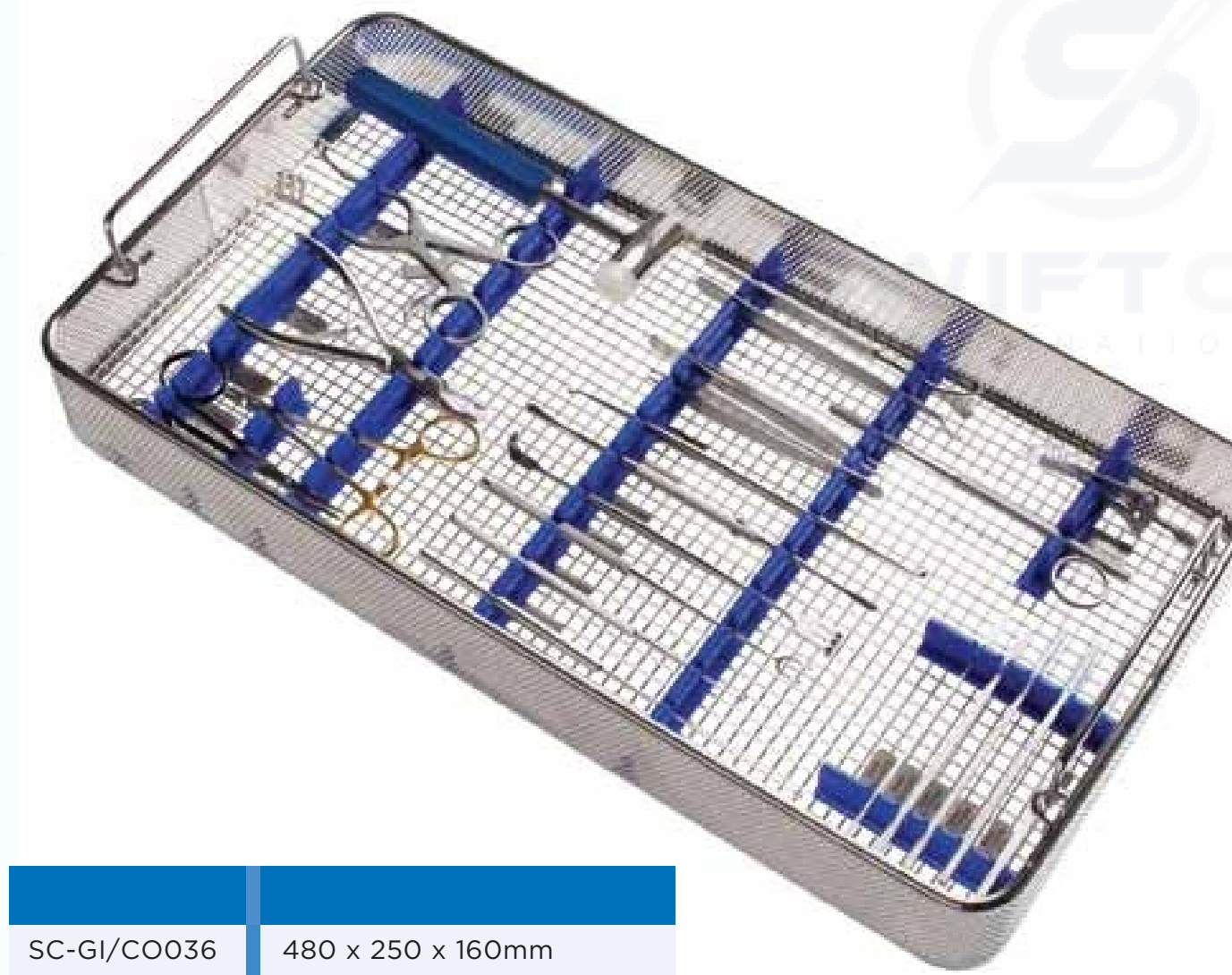

SC-GI/CO036	480 x 250 x 160mm
SC-GI/CO037	Fixing clamps

Sieve

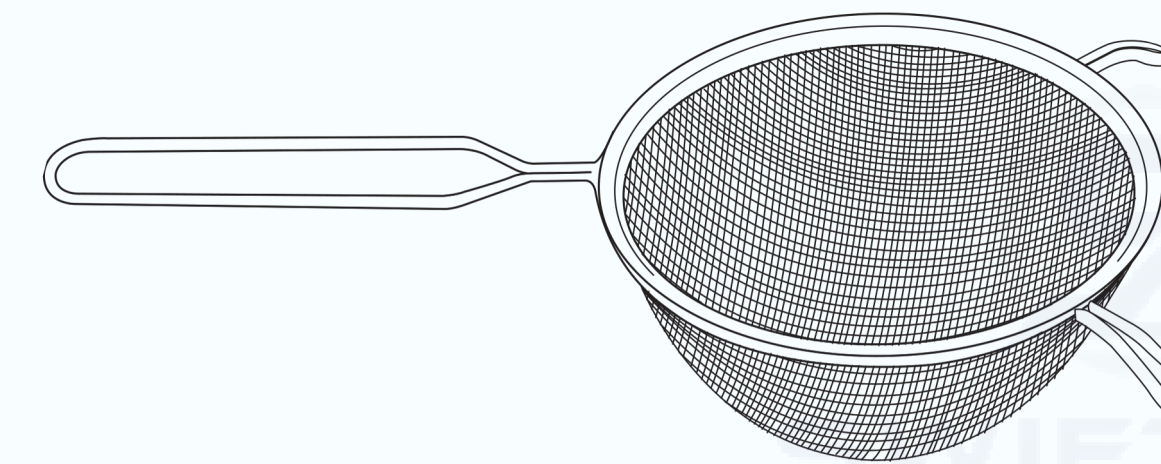

SC-GI/5071	203mm x 50mm ø
------------	----------------

Arthroscope Basket

Wire mesh base with two fixing clamps

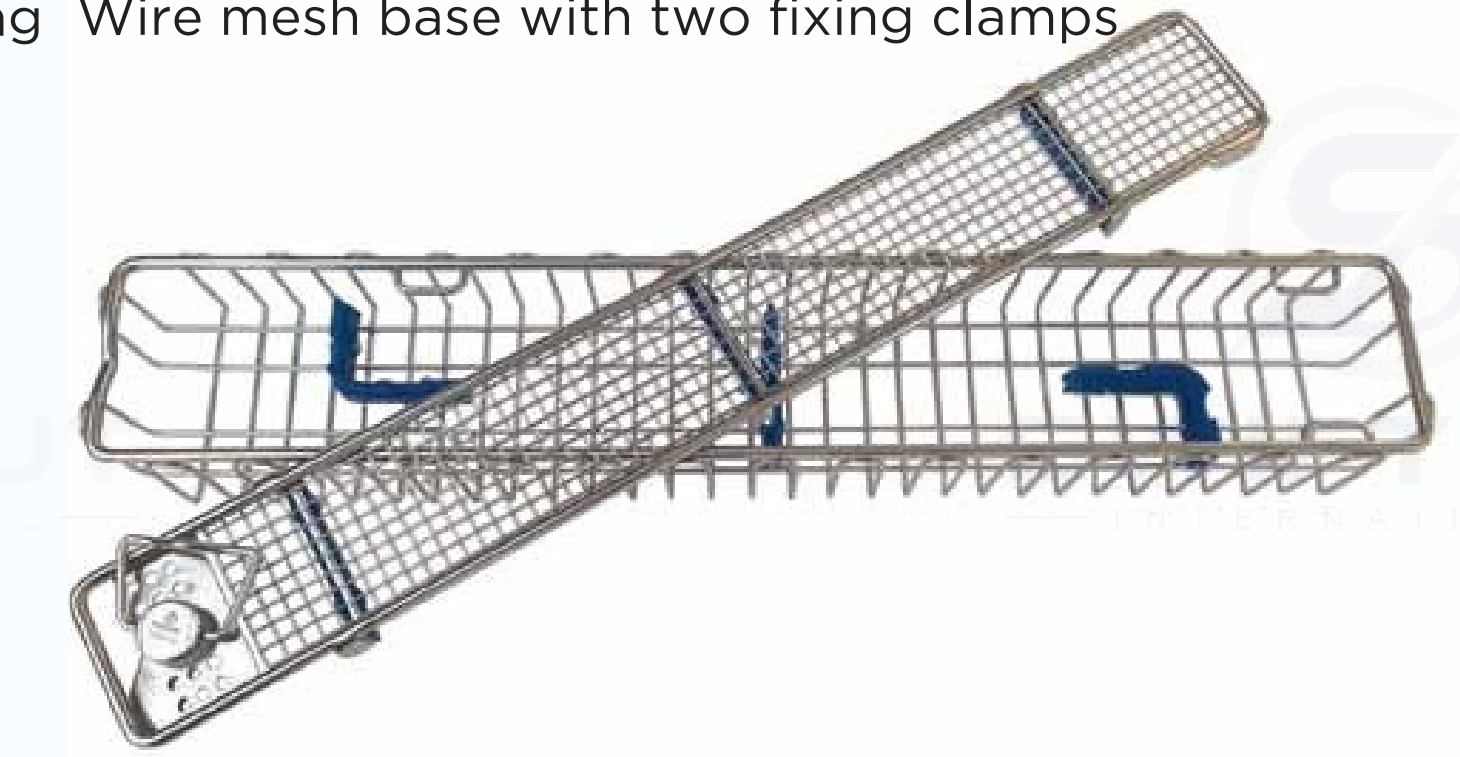

SC-GI/CO001	290 x 80 x 52mm
-------------	-----------------

Endoscope Basket

With small lensbasket

SC-GI/CO002	6400 x 150 x 77mm
-------------	-------------------

Wire mesh base with two fixing clamps

SC-GI/CO003	S - 460 x 80 x 52mm
SC-GI/CO004	D - 480 x 80 x 52mm
SC-GI/CO005	D - 680 x 80 x 52mm

Fine Mesh Basket



With hinged take off / lockable lid With separate lid

SC-GI/CO041	120 x 155 x 40mm	SC-GI/CO038	120 x 155 x 40mm
SC-GI/CO044	120 x 155 x 50mm	SC-GI/CO039	235 x 155 x 40mm
SC-GI/CO042	235 x 155 x 40mm	SC-GI/CO040	375 x 260 x 40mm
SC-GI/CO045	235 x 155 x 50mm		
SC-GI/CO043	375 x 260 x 40mm		

Contact us for full spec and to order
info@surgicalholdings.co.uk