

A comprehensive range of precision instruments designed for otorhinolaryngology procedures. This category includes specula, suction tubes, forceps, scissors, elevators, and mirrors tailored for delicate ear, nose, and throat surgeries. Ergonomic, lightweight designs ensure superior control, access, and visibility in confined anatomical spaces. Whether for diagnostic examination, microsurgery, or major head and neck procedures, each instrument is crafted for accuracy, durability, and gentle tissue handling.

# ENT INSTRUMENTS

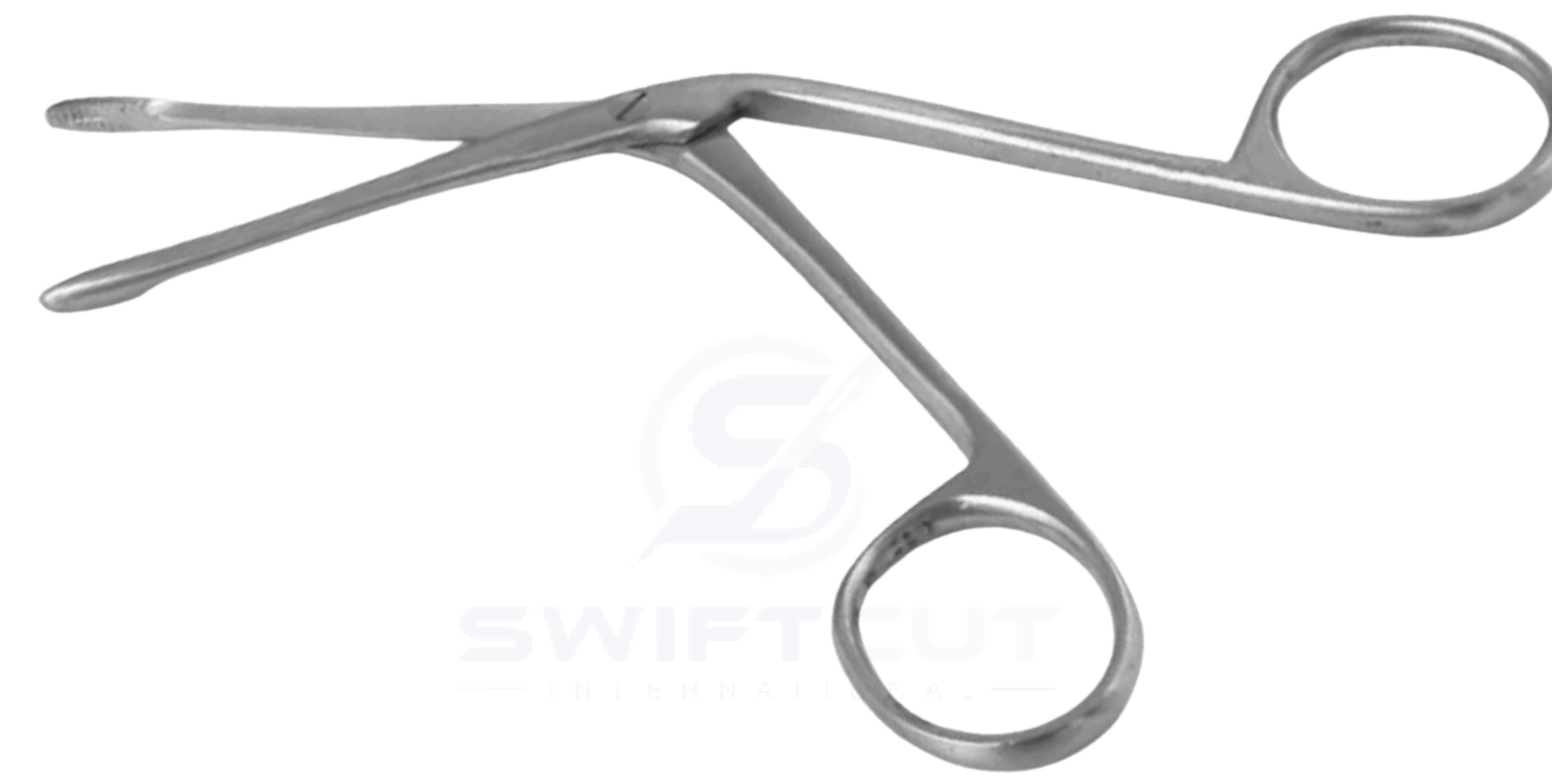

### Ironside Instruments

160mm long, black finish

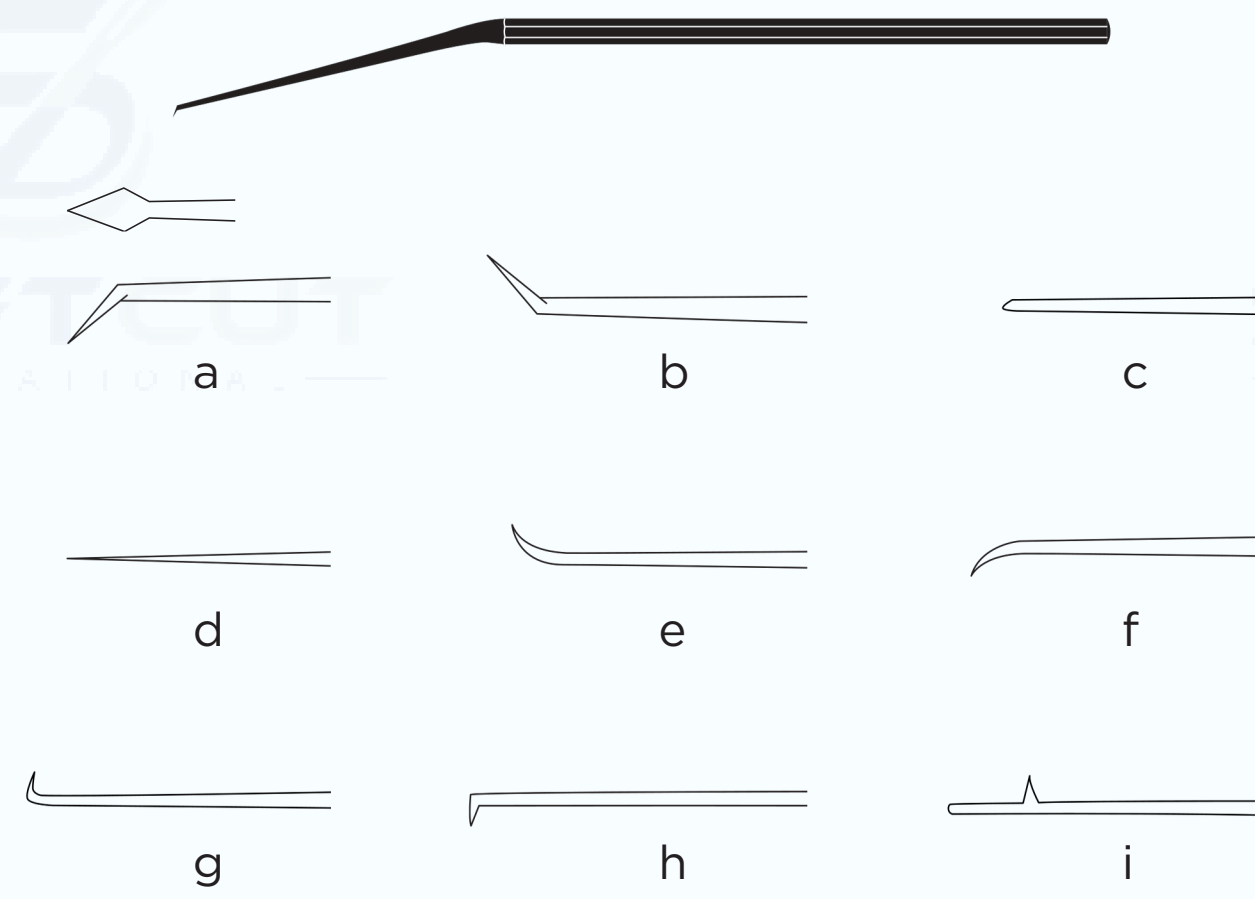

SC-ENT/200a	Knife 1, vertical incision
SC-ENT/200b	Knife 2, horizontal incision
SC-ENT/200c	Elevator
SC-ENT/200d	Needle point
SC-ENT/200e	Hook, superior elevation, angle 45°
SC-ENT/200f	Hook, inferior elevation, angle 45°
SC-ENT/200g	Hook, anterior elevation, angle 90° right
SC-ENT/200h	Hook, anterior elevation, angle 90° left
SC-ENT/200i	Measuring device

### Rosen Instruments

160mm long, black finish

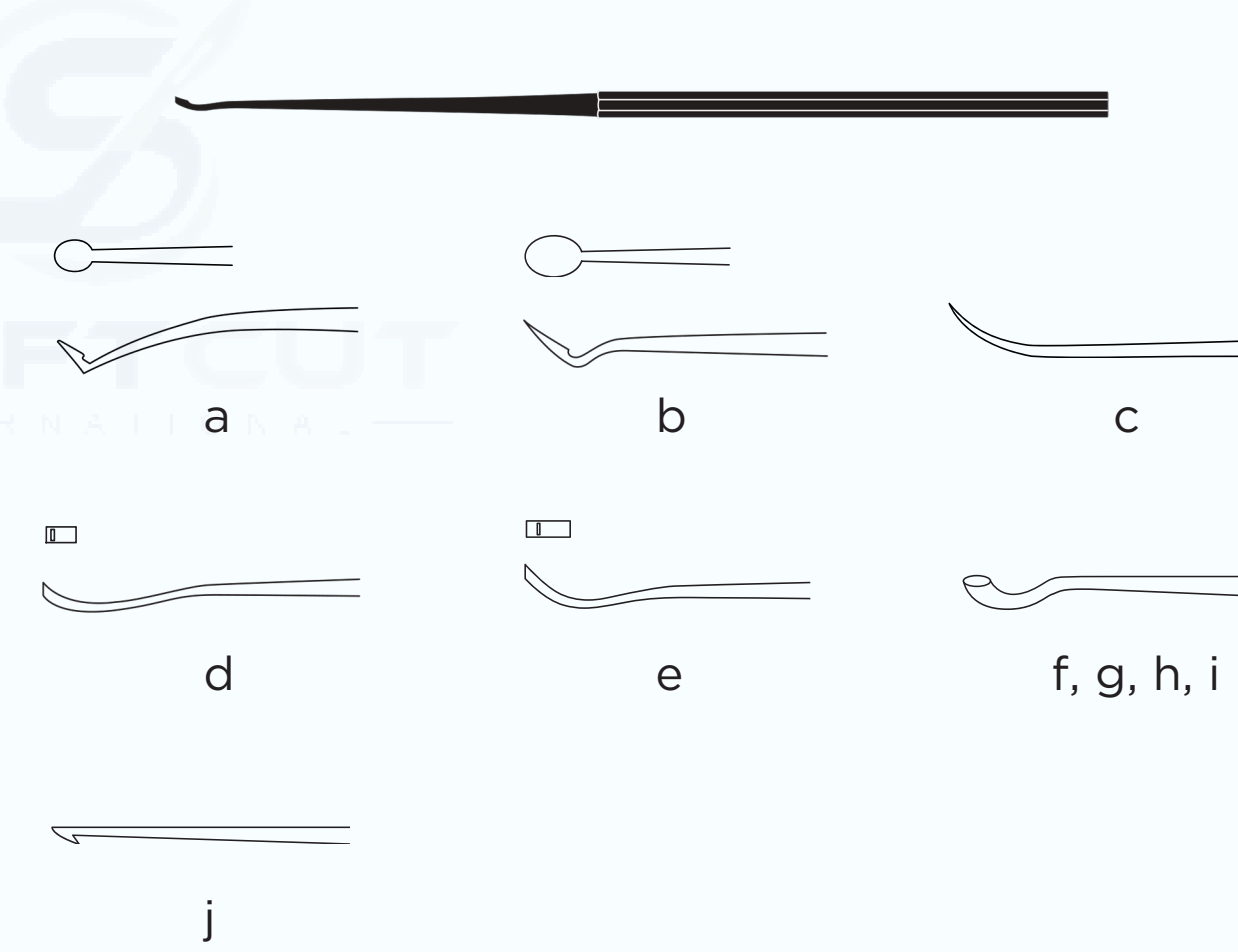

SC-ENT/202a	Curette, tympanic ring, small
SC-ENT/202b	Curette, tympanic ring, large
SC-ENT/202c	Probe, footplate movement test, fine
SC-ENT/202d	Mobiliser, slight curve
SC-ENT/202e	Mobiliser, full curve
SC-ENT/202f	Scoop, size 000
SC-ENT/202g	Scoop, size 00
SC-ENT/202h	Scoop, size 0
SC-ENT/202i	Scoop, size 1
SC-ENT/202j	Fenestrator, oval window

### Beale Instruments

170mm long, satin finish

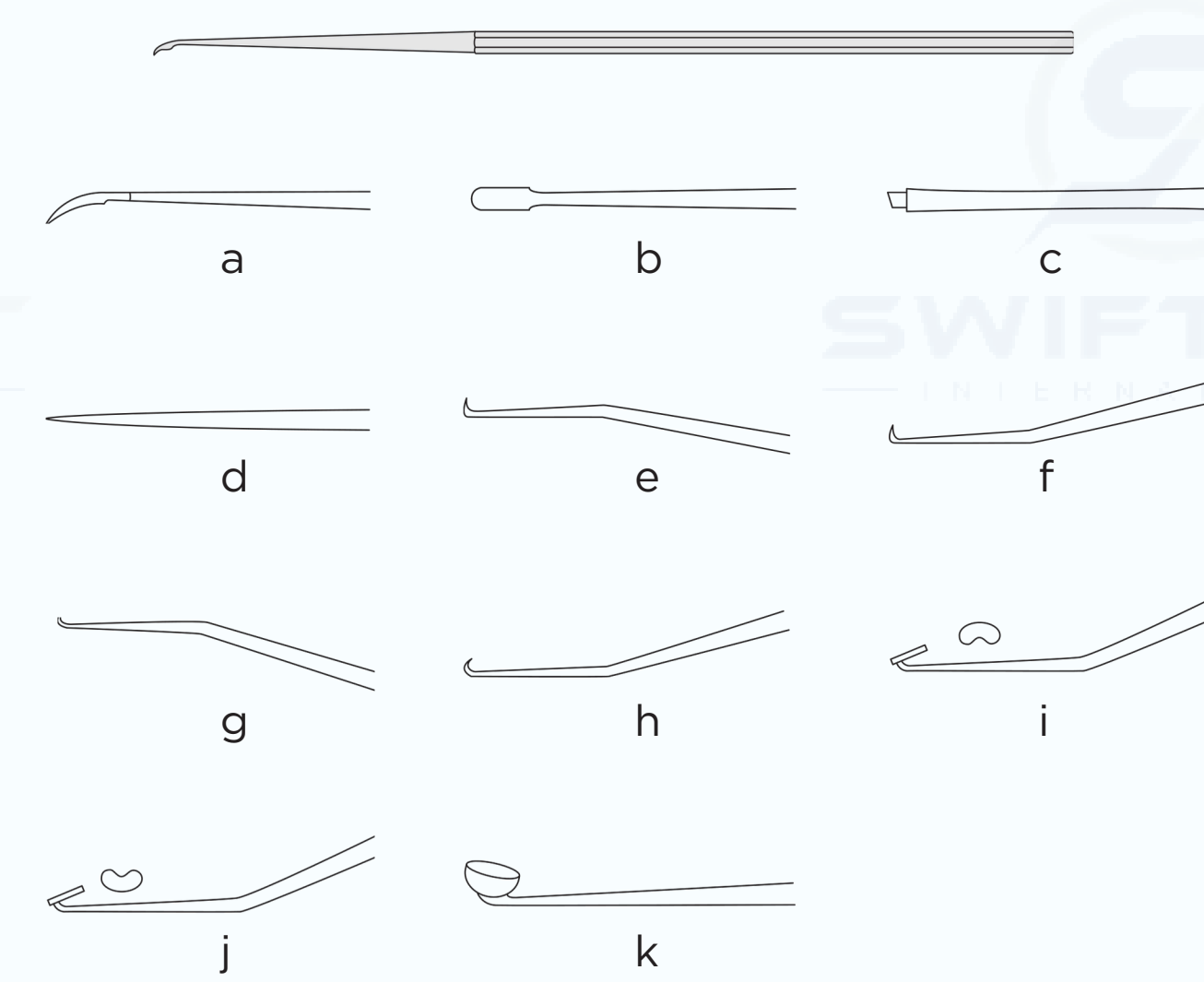

SC-ENT/203a	Knife, Stapedius tendon cutting
SC-ENT/203b	Raspatory, mucous removal
SC-ENT/203c	Osteotome, footplate
SC-ENT/203d	Perforator, elevation fixed footplate
SC-ENT/203e	Hook, removal of footplate, angled downward
SC-ENT/203f	Hook, removal of footplate, angled upward
SC-ENT/203g	Hook, bone removal from oval window, angled left
SC-ENT/203h	Applicator, vein graft for right ear
SC-ENT/203i	Applicator, vein graft for left ear
SC-ENT/203j	Curette, removal bony rim
SC-ENT/203k	Curette

### Hough Instruments

165mm long, stainless steel

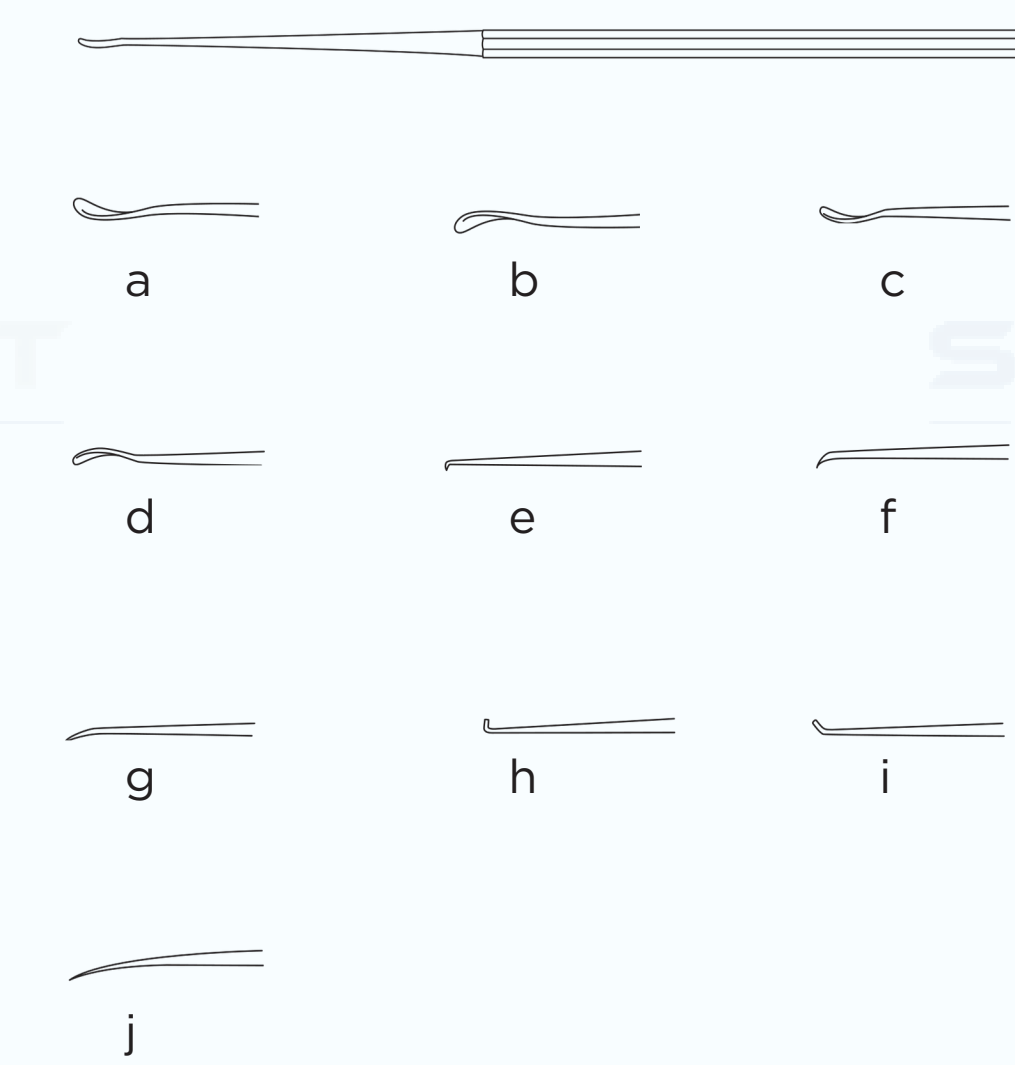

SC-ENT/205a	Excavator, "whirlybird", right, large
SC-ENT/205b	Excavator, "whirlybird", left, large
SC-ENT/205c	Excavator, "whirlybird", right, small
SC-ENT/205d	Excavator, "whirlybird", left, small
SC-ENT/205e	Pick, stapedectomy footplate, angled 90°, 0.33mm
SC-ENT/205f	Pick, stapedectomy footplate, angled 45°, 0.5mm
SC-ENT/205g	Pick, stapedectomy footplate, angled 15°, 0.5mm
SC-ENT/205h	Hook, "hoe", excavator, angled 90°
SC-ENT/205i	Hook, "hoe", excavator, angled 45°
SC-ENT/205j	Pick, curved

### Schuknecht Instruments

160mm long, black finish

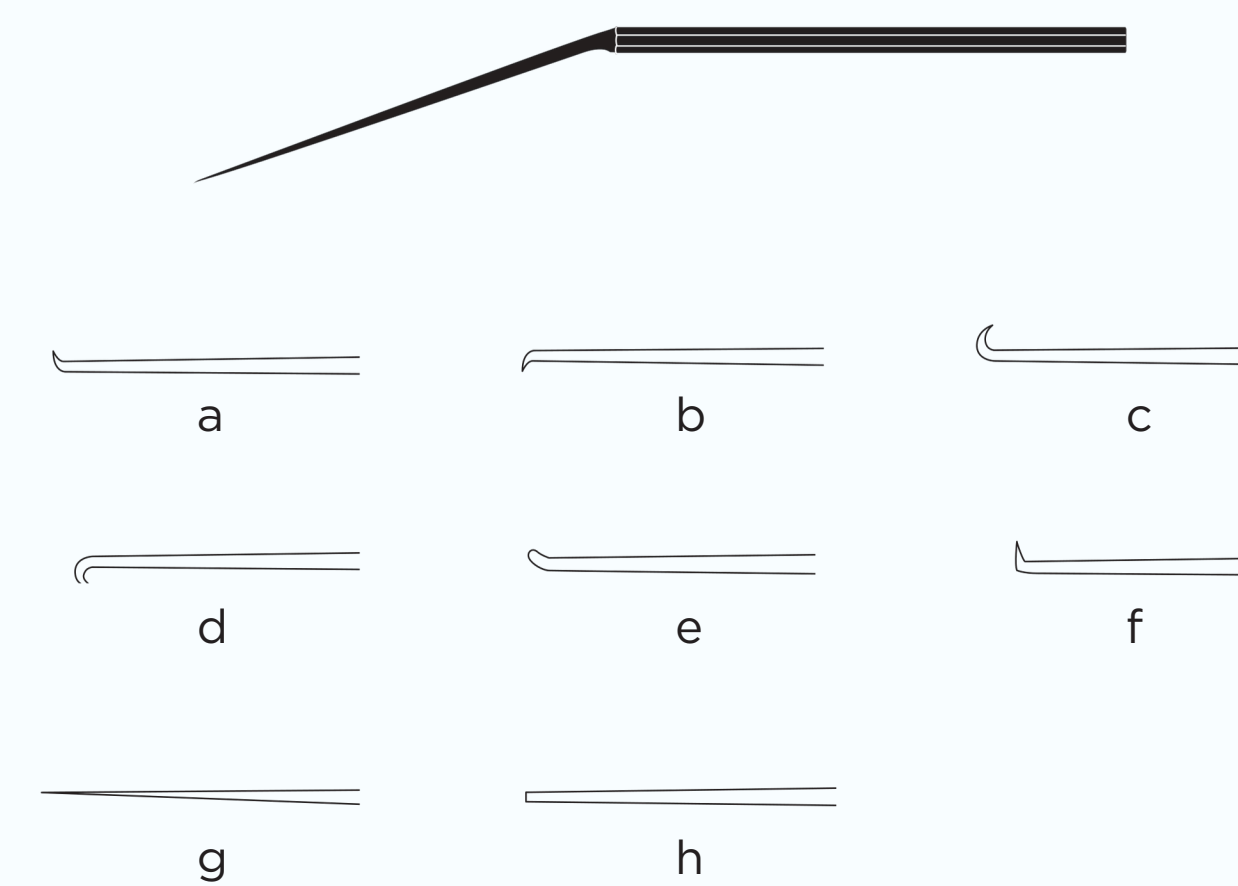

SC-ENT/201a	Hook upward, 0.4mm
SC-ENT/201b	Hook downward, 0.4mm
SC-ENT/201c	Hook upward, 0.7mm
SC-ENT/201d	Hook downward, 0.7mm
SC-ENT/201e	Elevator, oval
SC-ENT/201f	Hook, right-angled upward
SC-ENT/201g	Pick, straight
SC-ENT/201h	Spatula

### Beale Instruments

165mm long, satin finish

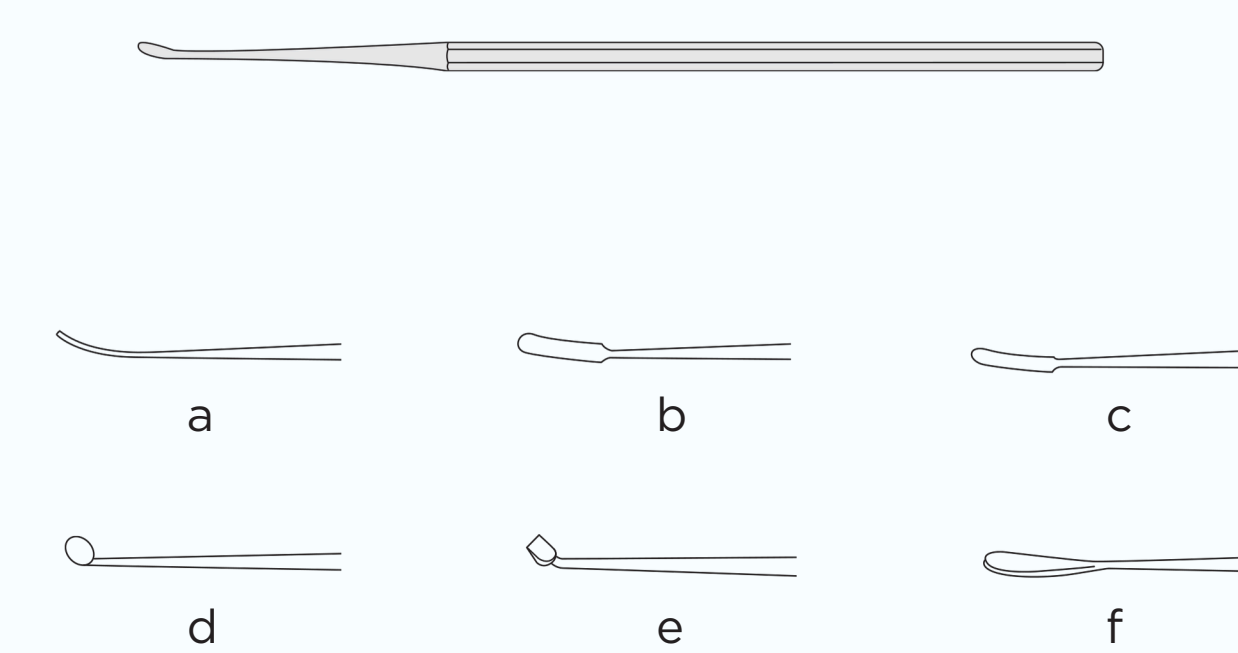

SC-ENT/204a	Tympanoplasty probe, fine blunt end
SC-ENT/204b	Raspatory, slight curve
SC-ENT/204c	Raspatory, slight curve, small
SC-ENT/204d	Rugine, double ended, sharp
SC-ENT/204e	Rugine, double ended
SC-ENT/204f	Spatula, graft smoothing

### Cawthorne Hooks

165mm long, black finish

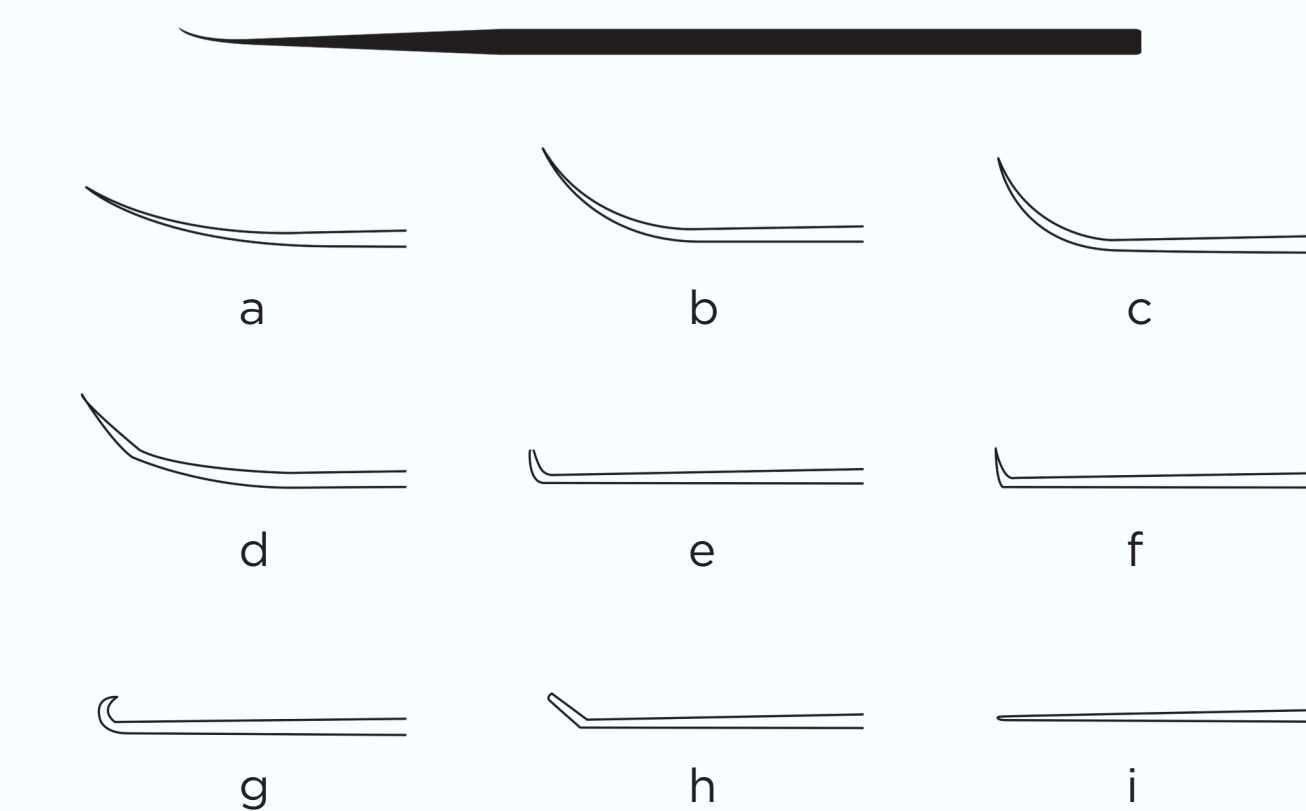

SC-ENT/206a	Slight curve
SC-ENT/206b	Medium curve
SC-ENT/206c	Full curve
SC-ENT/206d	Double curve
SC-ENT/206e	90° angle, 0.5mm
SC-ENT/206f	90° angle, 1.0mm
SC-ENT/206g	45° angle, 0.5mm
SC-ENT/206h	Retrograde
SC-ENT/206i	Straight

### Musgrove Cerumen Pick and Wool Carrier

Double ended



SC-ENT/024	178mm long
------------	------------

### Formby Cerumen Scoop and Hook

Double ended



SC-ENT/026	178mm long
------------	------------

### Hovell Loop

Fine, for removing hard wax



SC-ENT/027	152mm long
------------	------------

### Lempert Scoop

Oval, 200mm long

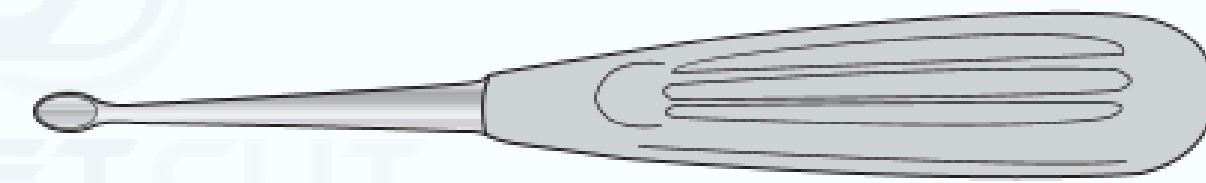

SC-ENT/066a	2mm x 2.5mm
SC-ENT/066b	2mm x 3.5mm
SC-ENT/066c	2mm x 4mm
SC-ENT/066d	2mm x 4.5mm
SC-ENT/066e	3mm x 5.5mm
SC-ENT/066f	3mm x 6mm

### House Curette

Double ended, 180mm long



SC-SH/5213	Straight
SC-SH/5213a	Angled

### Balance Scoop and Curette



SC-ENT/038	230mm long
------------	------------

### Hartmann Hook

Sharp, straight shaft

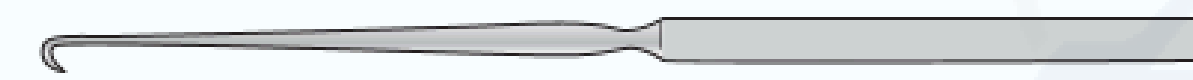

SC-ENT/021	140mm long
------------	------------

### Cawthorne Cerumen Hook

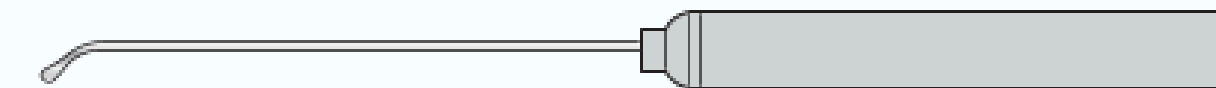

SC-ENT/023	143mm long
------------	------------

### Tracheal Hook

Sharp

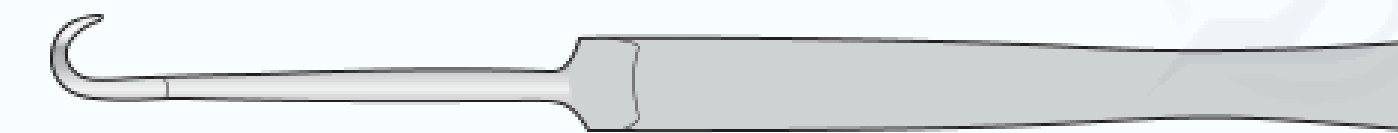

SC-ENT/SH.5672	165mm long
----------------	------------

### Tracheal Single Hook Retractor

Sharp



SC-GI/SH5671	152mm long
--------------	------------

### Tracheal Double Hook

Blunt



SC-ENT/SH.5673	105mm long
----------------	------------

### Gardiner Brown Hook and Imray Loop

Doubled ended

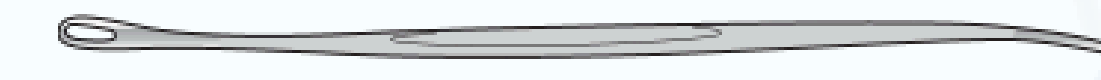

SC-ENT/025	127mm long
------------	------------

### St Bart's Hook

Blunt, straight handle



SC-ENT/022	178mm long
------------	------------

### McIndoe Skin Hook

Fine, with flat handle

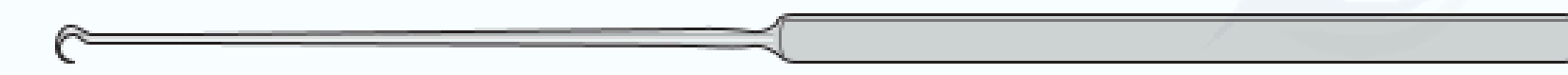

SC-ENT/057	191mm long
------------	------------

### Cawthorne Probe

Silver, flattened end

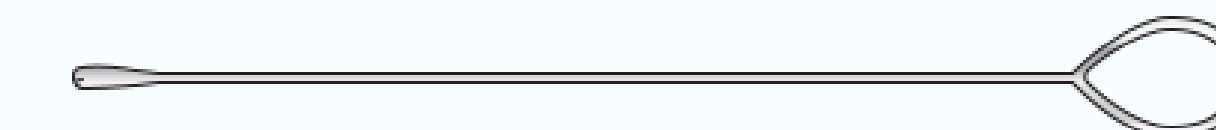

SC-ENT/019	140mm long
------------	------------

### Jobson Horne Probe

Doubled ended, serrated tip and smooth ring



SC-ENT/020a	140mm long
SC-ENT/020b	178mm long

### Mollison Retractor

Self retaining, curved

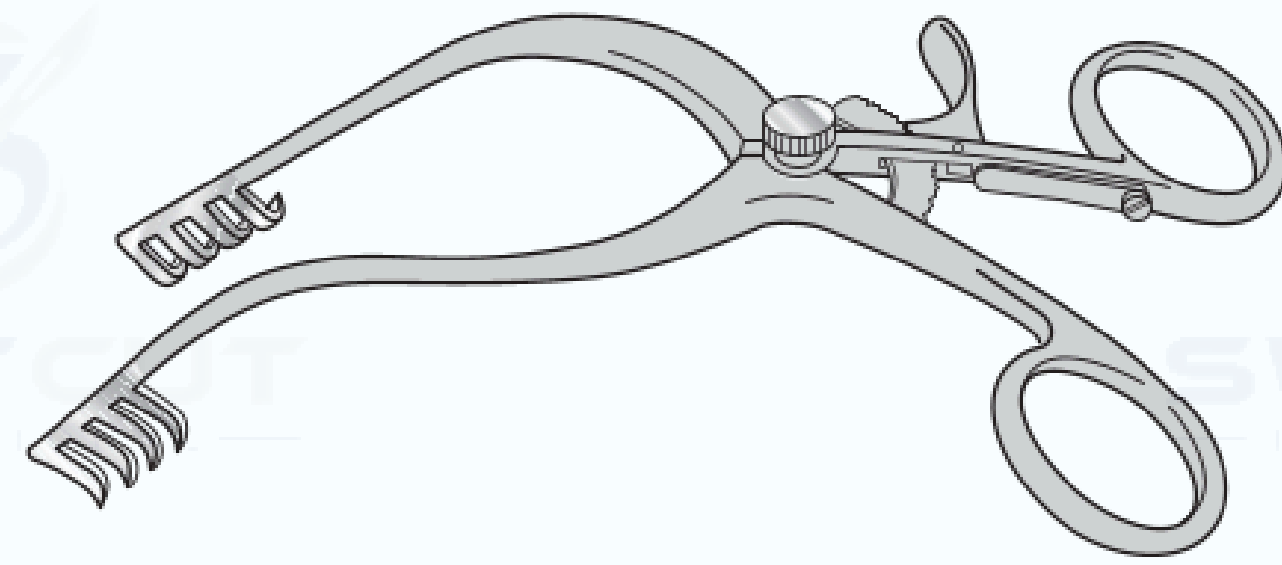

SC-ENT/034a	4-4 teeth, adult, 165mm long
SC-ENT/034b	2-2 teeth, child, 133mm long

### Plester-Jansen Retractor

Solid blade one side, 140mm long

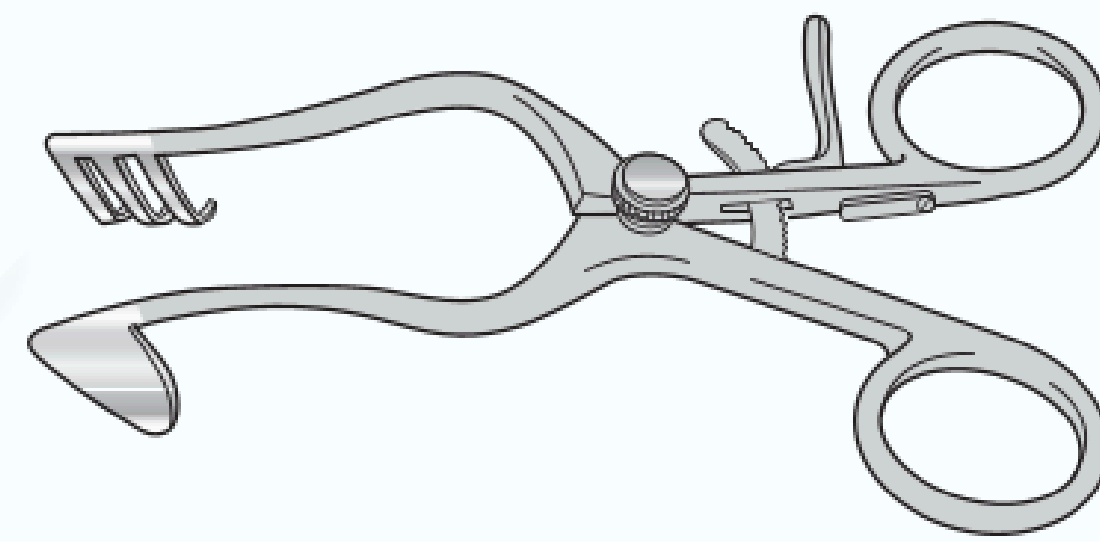

Sc-Ent/061A	Left
Sc-Ent/061B	Right
Sc-Ent/061C	3 x 3 Teeth

### Hurd Pillar Retractor and Tonsil Dissector

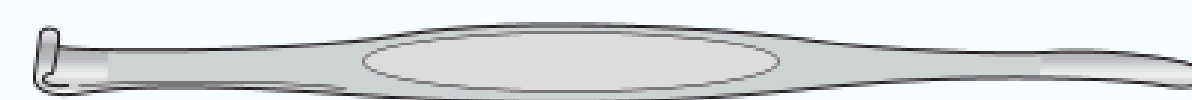

SC-ENT/147	197mm long
------------	------------

### Wallace Modified Plester Retractor

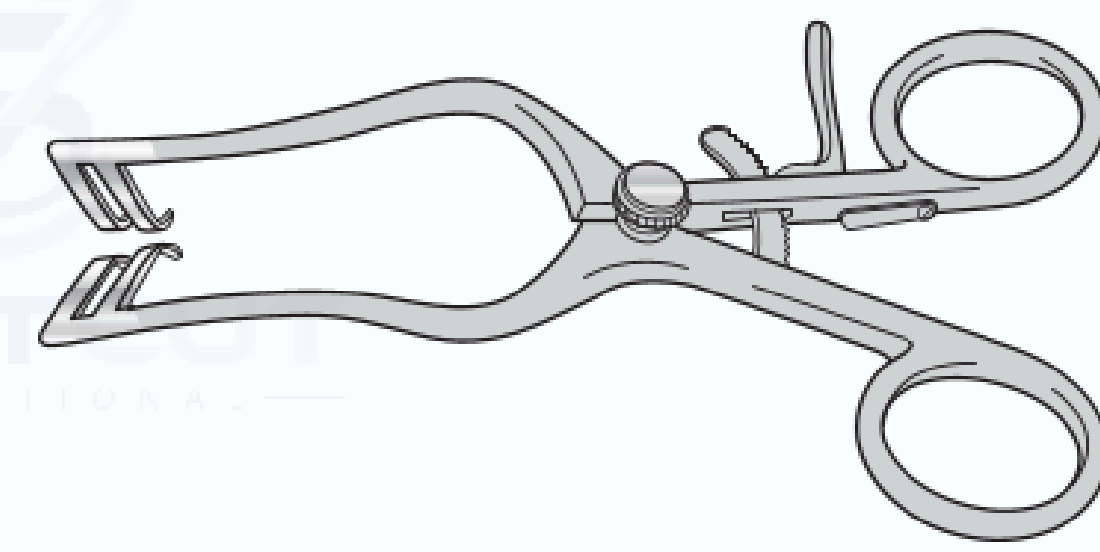

SC-ENT/062	2 x 2 teeth, 140mm long
------------	-------------------------

### Shah Intra Aural Retractor

Satin finish 152mm long

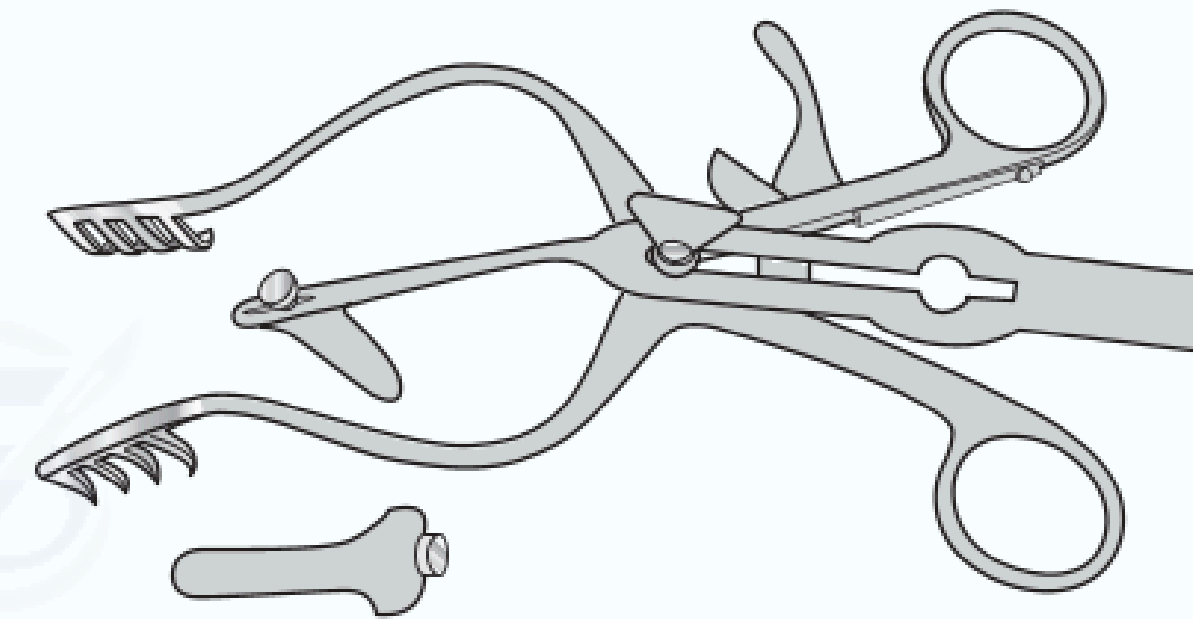

SC-ENT/060a	4-4 teeth, adult, 165mm long
SC-ENT/060b	Third blade
SC-ENT/060c	Intra aural blade
SC-ENT/060d	Post aural blade

### Mollison Anterior Pillar Retractor and Tonsil Enucleator

Semi sharp



SC-ENT/148	210mm long
------------	------------

### Ipswich Pattern Sucker

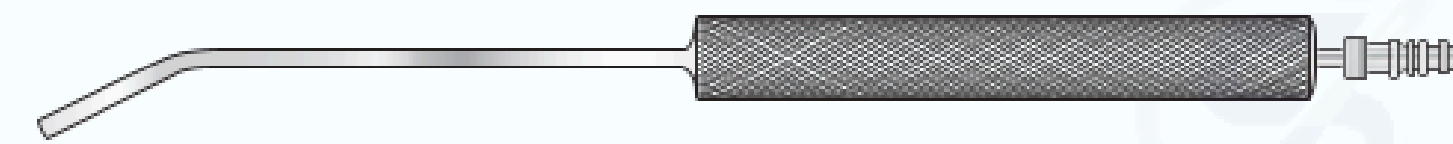

SC-ENT/050a	267mm long
-------------	------------

### Formby Suction Tube

Angled, conical, tip size 10F.G. stainless steel

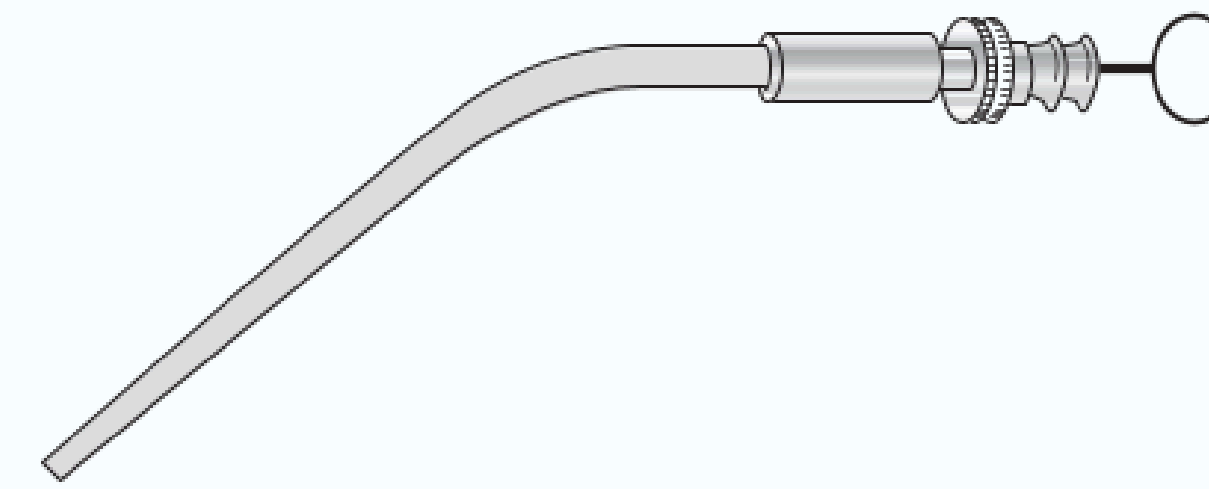

SC-ENT/042	210mm long
------------	------------

### Barron Suction Tube

Smallsize, 4 F.G. Not for use with Zoellner ends

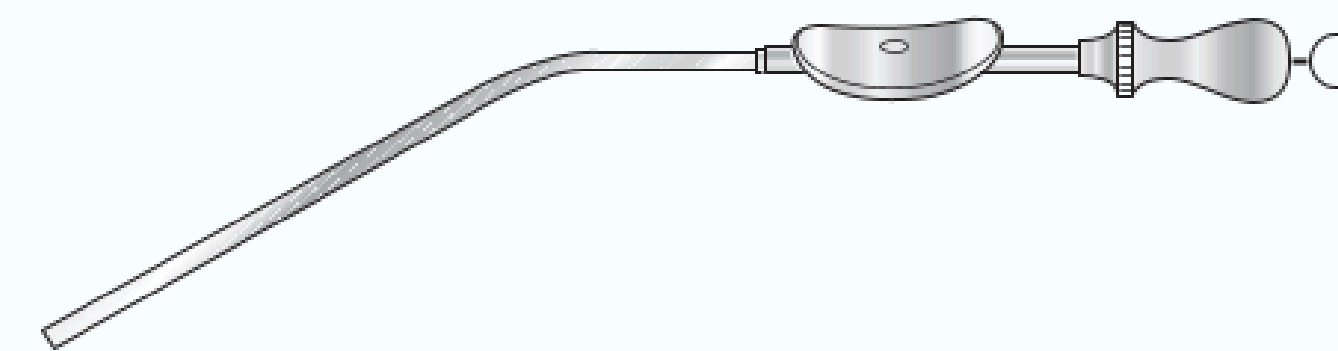

SC-ENT/041	229mm long
------------	------------

### House Suction and Irrigation Tubes

Stainless steel, 152mm long

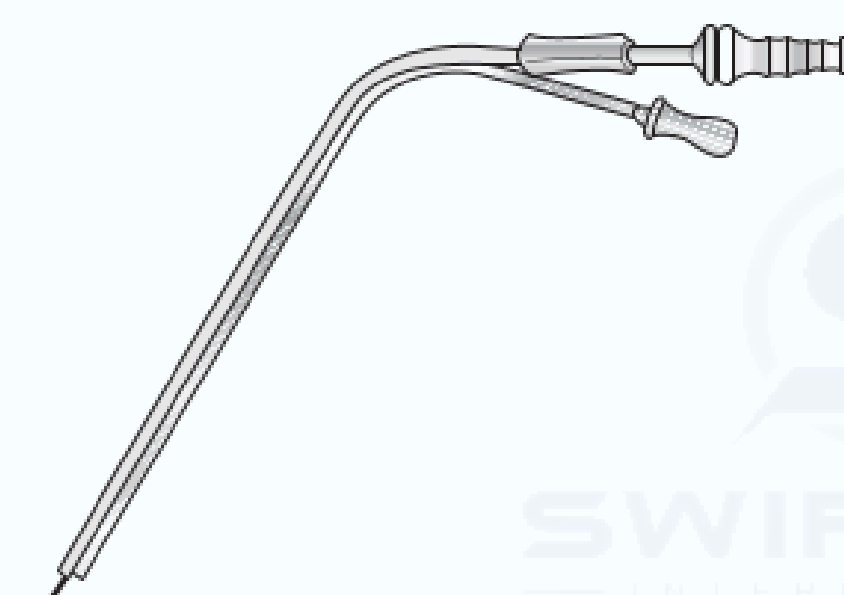

SC-ENT/043	8 F.G. x 6 F.G.
SC-ENT/043a	10 F.G. x 7 F.G.
SC-ENT/043b	12 F.G. x 8 F.G.

### Lempert Suction and Irrigation Tubes

With tucker valve and stilette for cleaning stainless steel, 203mm

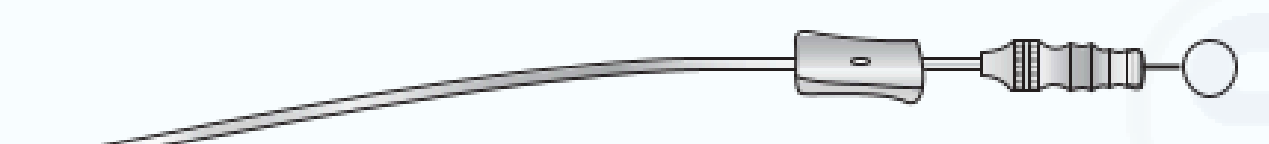

SC-ENT/044	6F.G. 2mm
SC-ENT/044a	9F.G. 3mm

### Magill Suction Tubes

Set of four with conical ends, one curved, three angled, handle, stainless steel, 210mm

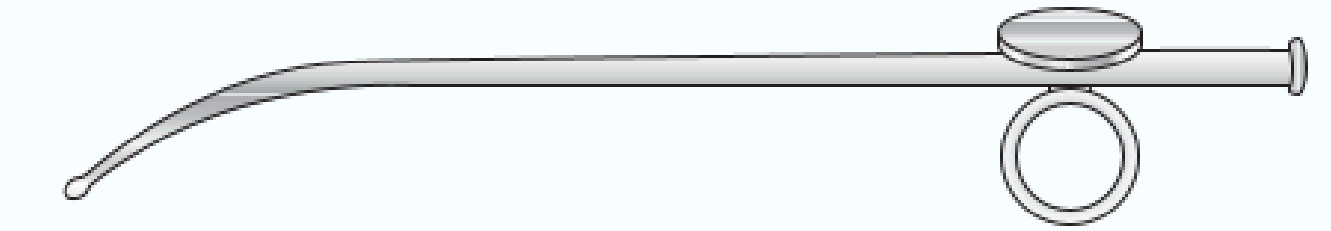

SC-ENT/045	Various sizes
SC-ENT/046a	3.0mm ø
SC-ENT/046b	3.5mm ø
SC-ENT/046c	4.0mm ø

### Zoellner Suction Tube

Withstilette, stainless steel

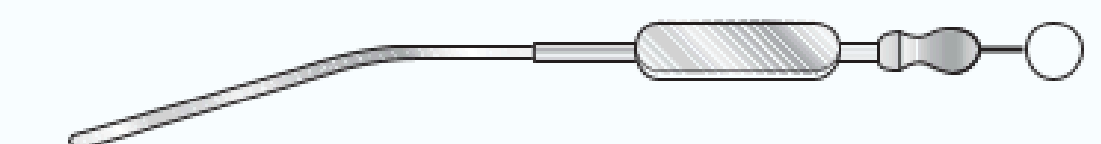

SC-ENT/047	170mm long, 2mm ø
------------	-------------------

### Rowbotham Suction Tube

SC-ENT/169	286mm long
------------	------------

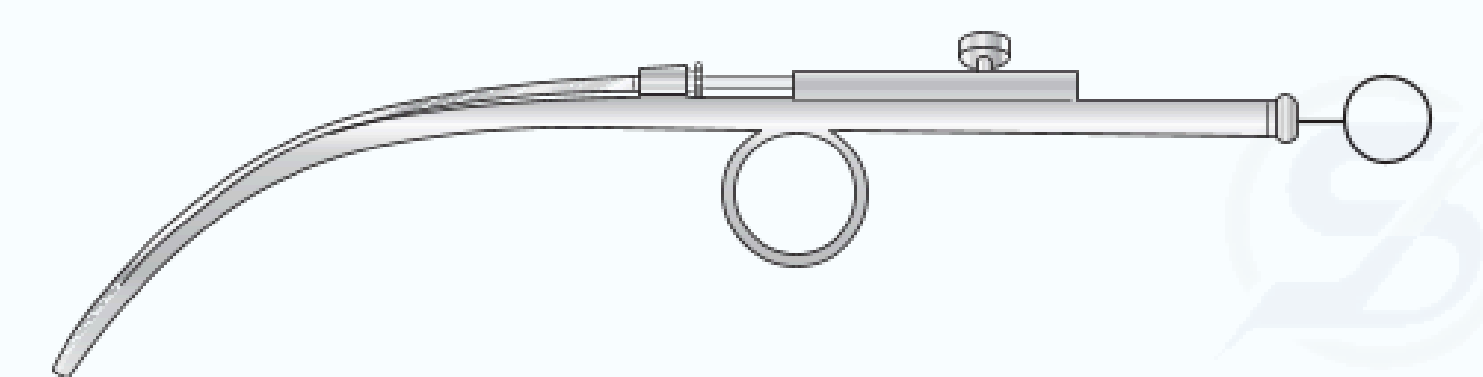

### Rosen Slotted Speculum

Set of four, round ends, black finish 38mm long

SC-ENT/049j	Set of 4
SC-ENT/049f	4mm
SC-ENT/049g	5mm
SC-ENT/049h	6mm
SC-ENT/049i	7mm

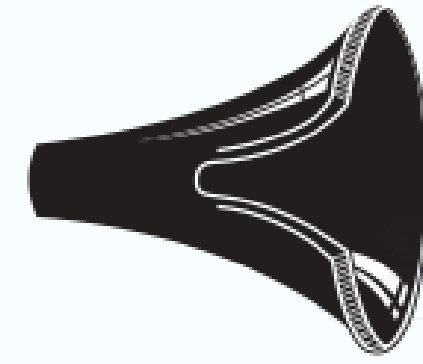

### Rosen Aural Speculum

Round, 40mm long

SC-ENT/049a	3mm
SC-ENT/049b	4mm
SC-ENT/049c	5mm
SC-ENT/049d	6mm
SC-ENT/049e	7mm

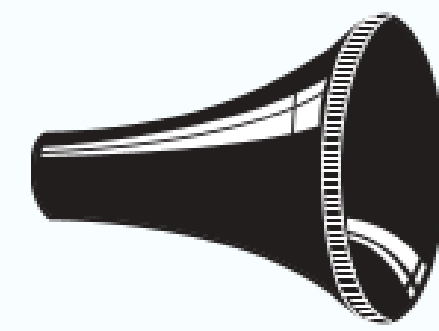

### Shea Speculum

Set of five, oblique ends, black finish, 38mm long

SC-ENT/050	Set of 5
SC-ENT/051	3mm
SC-ENT/051a	4mm
SC-ENT/051b	5mm
SC-ENT/051c	6mm
SC-ENT/051d	7mm

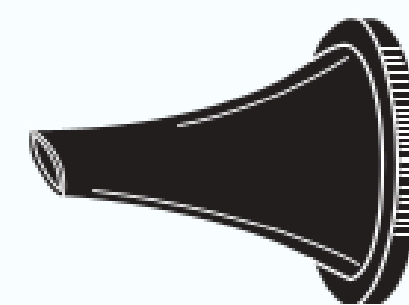

### Tumarkin Speculum

Set of eight, taper ends lot, black finish 50mm long

SC-ENT/052	Set of 8
SC-ENT/053a	4.5mm ø
SC-ENT/053b	6.5mm ø
SC-ENT/053c	7.0mm ø
SC-ENT/053d	7.5mm ø
SC-ENT/053e	8.0mm ø
SC-ENT/053f	8.5mm ø
SC-ENT/053g	9.0mm ø
SC-ENT/053h	11.0mm ø

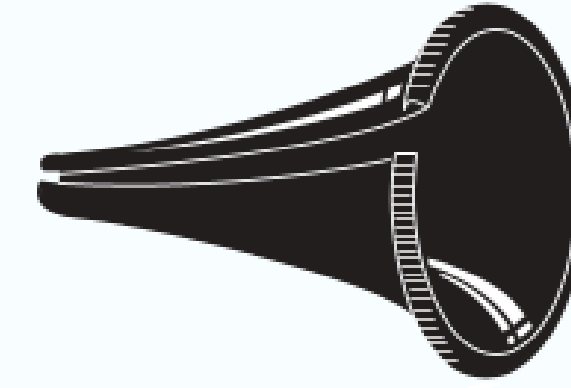

### Heath Speculum

Set of four, black finish 50mm long

SC-ENT/207e	Set of 4
SC-ENT/207a	4.0mm ø
SC-ENT/207b	5.0mm ø
SC-ENT/207c	6.0mm ø
SC-ENT/207d	7.0mm ø



### Peters Seigle Speculum

SC-ENT/366	Peters ear speculum black chrome finish set of 5, sizes 0 to 4
SC-ENT/189i	2.2mm x 3.2mm
SC-ENT/189j	2.8mm x 4.2mm
SC-ENT/189k	4.3mm x 5.8mm
SC-ENT/189l	5.2mm x 7.6mm
SC-ENT/189m	6.0mm x 7.6mm
SC-ENT/189d	6mm
SC-ENT/189e	7mm
SC-ENT/189f	8mm
SC-ENT/189g	9mm
SC-ENT/189h	10mm

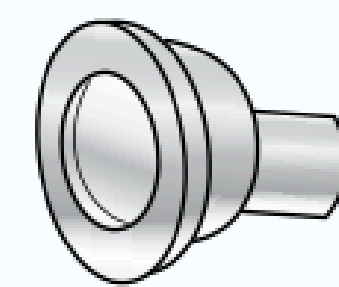

### St Clair Thompson Nasal Speculum Killian Nasal Speculum

SC-ENT/072	38mm long
SC-ENT/072a	51mm long
SC-ENT/072b	64mm long
SC-ENT/072c	89mm long

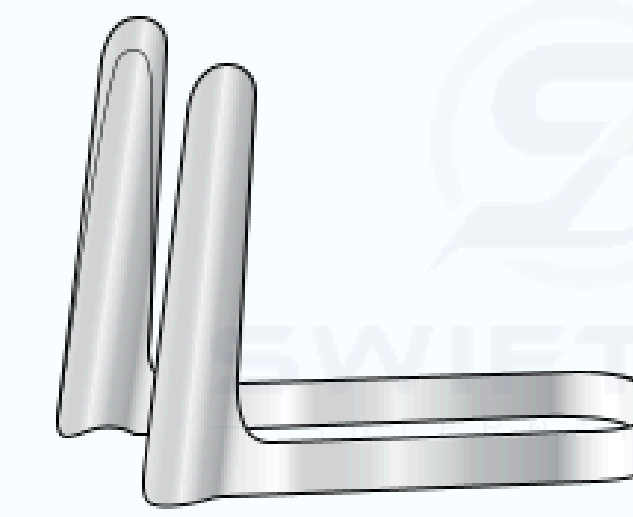

#### With Stop

SC-ENT/081a	51mm blade
SC-ENT/081b	64mm blade
SC-ENT/081c	76mm blade
SC-ENT/081d	89mm blade

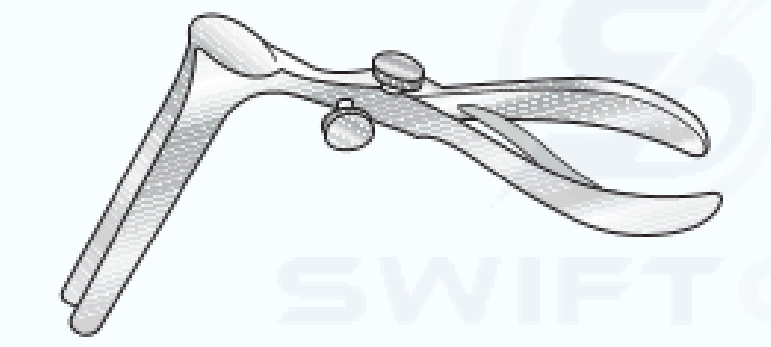

#### Without Stop

SC-ENT/082b	76mm blade
-------------	------------

### Thudichum Nasal Speculum

Set of seven, sizes 1-7, 70mm long

SC-ENT/073a	Standard
SC-ENT/073b	Insulated

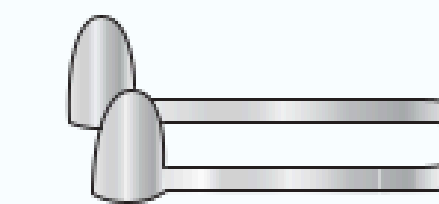

#### Standard

SC-ENT/073a	Size 1 - 12mm blade
SC-ENT/073a	Size 2 - 14mm blade
SC-ENT/073a	Size 3 - 16mm blade
SC-ENT/073a	Size 4 - 18mm blade
SC-ENT/073a	Size 5 - 20mm blade
SC-ENT/073a	Size 6 - 22mm blade
SC-ENT/073a	Size 7 - 24mm blade
SC-ENT/073a	Size 8 - 27mm blade

#### Insulated

SC-ENT/073b	Size 1 - 12mm blade
SC-ENT/073b	Size 2 - 14mm blade
SC-ENT/073b	Size 3 - 16mm blade
SC-ENT/073b	Size 4 - 18mm blade
SC-ENT/073b	Size 5 - 20mm blade
SC-ENT/073b	Size 6 - 22mm blade
SC-ENT/073b	Size 7 - 24mm blade
SC-ENT/073b	Size 8 - 27mm blade

### Lempert Endaural Speculum

SC-ENT/060e	133mm long
-------------	------------

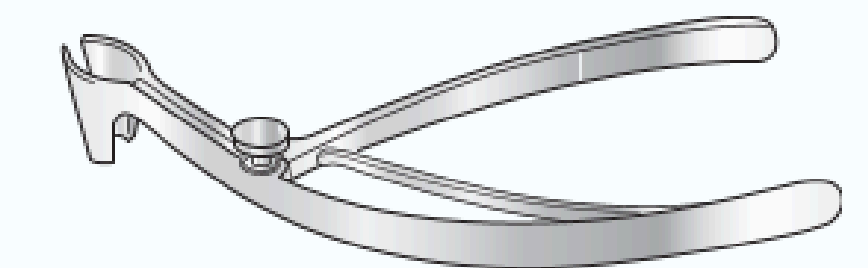

### Pilcher Nasal Speculum

SC-ENT/071	152mm
------------	-------

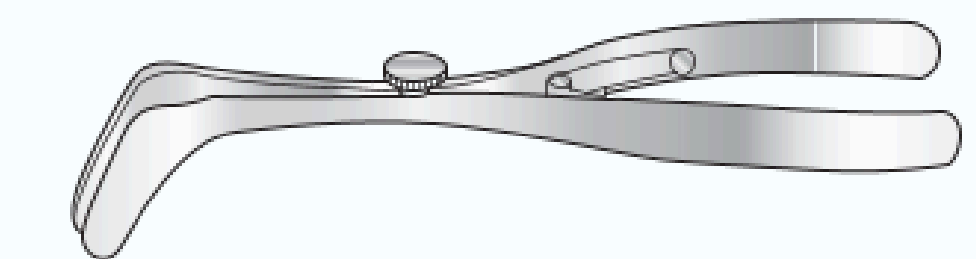

### Cottle Nasal Speculum

127mm long

SC-ENT/192c	20mm blade
SC-ENT/192b	32mm blade
SC-ENT/192	41mm blade
SC-ENT/192a	60mm blade

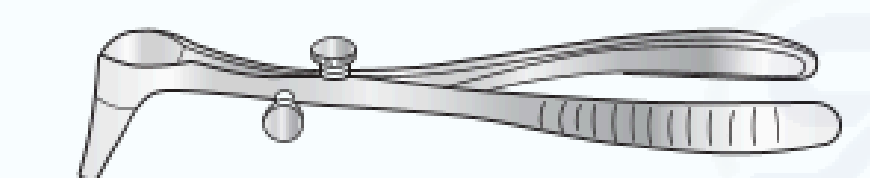

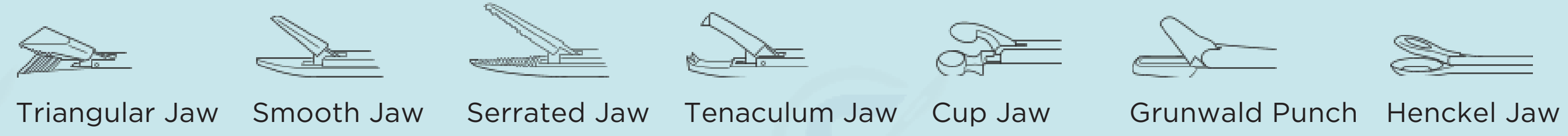

### Beale Aural Forceps

Micro, black finish, triangular flat jaws, serrated



SC-ENT/183	70mm to shoulder
------------	------------------

### Hough Aural Forceps

Micro, extra fine oval cup jaws, black finish



SC-ENT/059	70mm to shoulder
------------	------------------

### Cawthorne Aural Forceps

Micro, black finish, extra fine  
70mm to shoulder



SC-ENT/182	Smooth jaws
SC-ENT/199	Serrated jaws

### Ormerod Aural Forceps

Micro, extra fine, black finish  
70mm to shoulder



SC-ENT/184a	Serrated, angled upwards
SC-ENT/184b	1mm cup jaw
SC-ENT/184c	Elongated cup jaw, 0.5 x 4mm

### Hartmann Aural Forceps

Micro, black finish  
75mm to shoulder

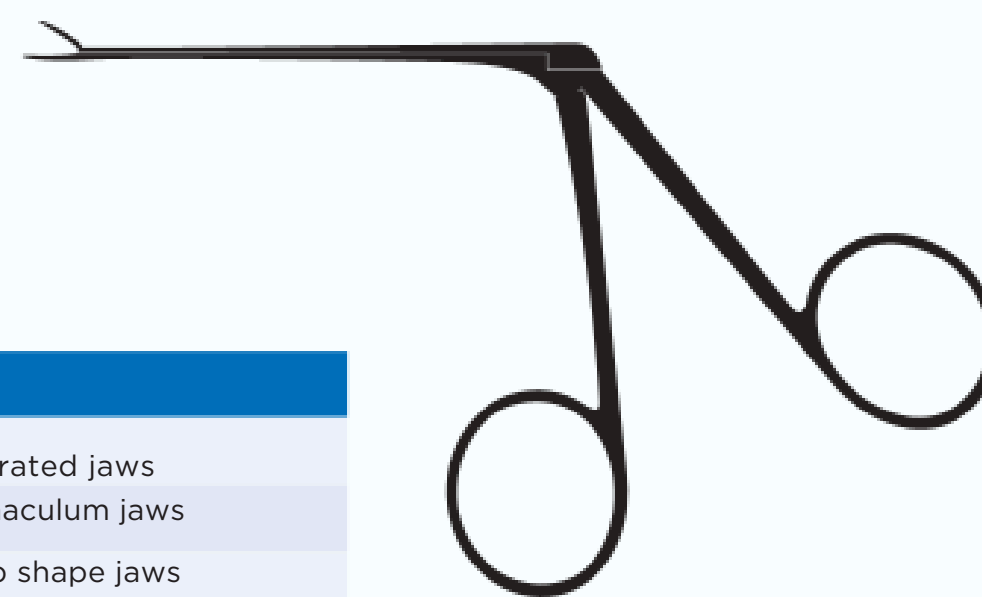

SC-ENT/058	Serrated jaws
SC-ENT/058a	Tenaculum jaws
SC-ENT/058b	Cup shape jaws
SC-ENT/058c	Curved left, serrated
SC-ENT/058d	Curved right, serrated
SC-ENT/058e	Angled up, serrated
SC-ENT/058f	Serrated jaws, satin finish
SC-ENT/058s	Pre-sterile - single use only

### Shea Aural Forceps

Micro, oval cup jaw, black  
finish 70mm to shoulder



SC-ENT/069	Standard
SC-ENT/069a	Curved to left
SC-ENT/069b	Curved to right
SC-ENT/069c	Curved upward

### Hartmann Aural Forceps

Standard, satin finish  
75mm to shoulder

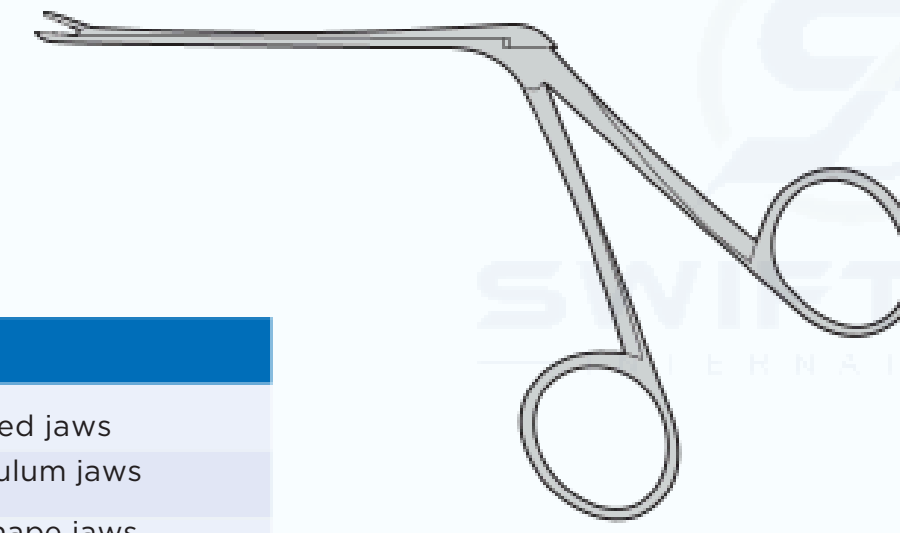

SC-ENT/181	Serrated jaws
SC-ENT/181a	Tenaculum jaws
SC-ENT/181b	Cup shape jaws
SC-ENT/181c	Grunwald punch action

### Heath Aural Forceps

Light, with lifting discs, serrated jaws

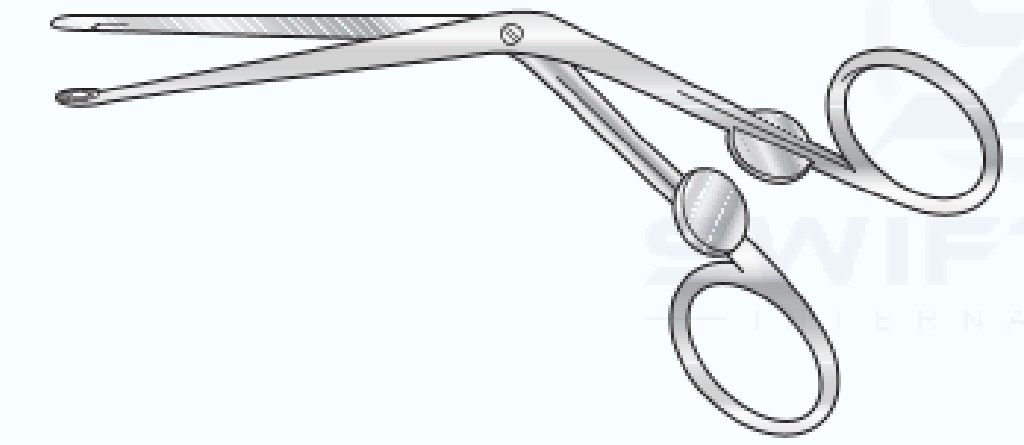

SC-ENT/175	83mm to shoulder
------------	------------------

### Henckel Aural Forceps

Fine fenestrated scoop blades

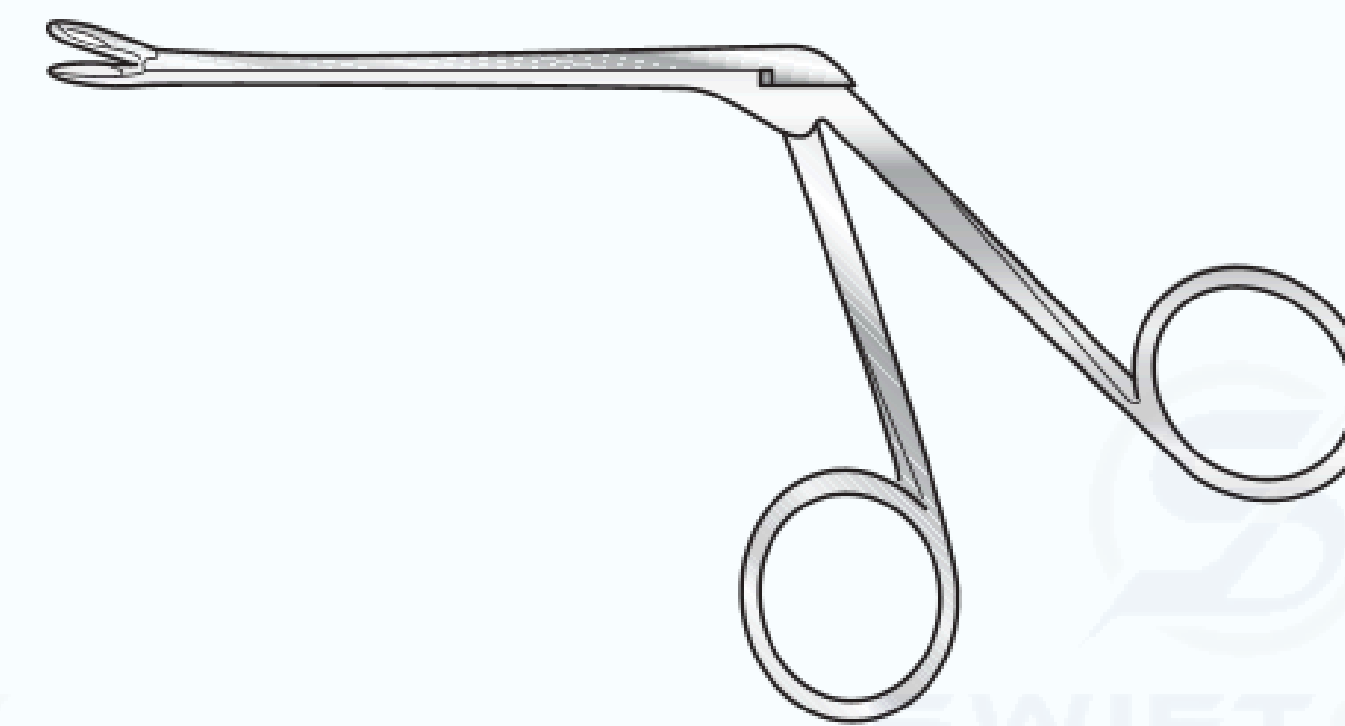

SC-ENT/176	75mm to shoulder
------------	------------------

### Struycken Cutting Forceps

75mm to shoulder

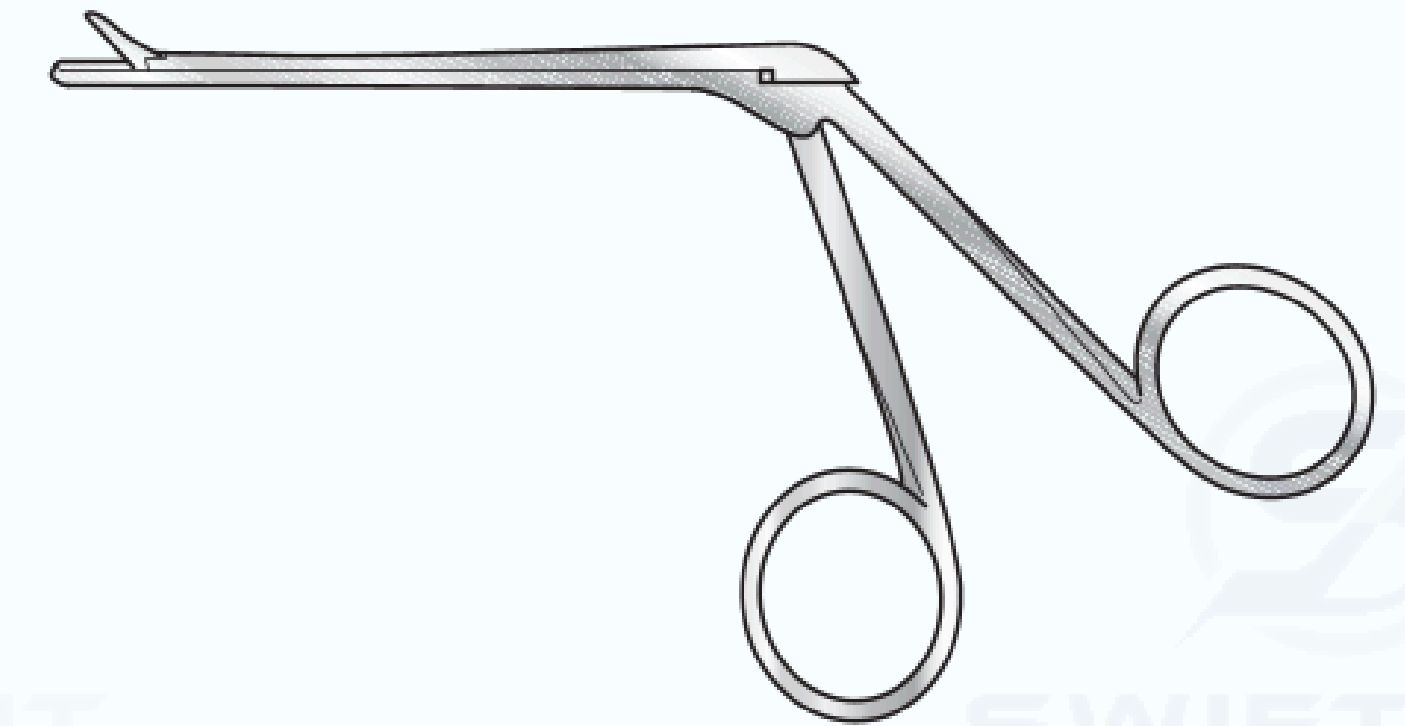

SC-ENT/178	Fenestrated under jaw
------------	-----------------------

### Birkett Tonsil Artery Forceps

Fine, 178mm long

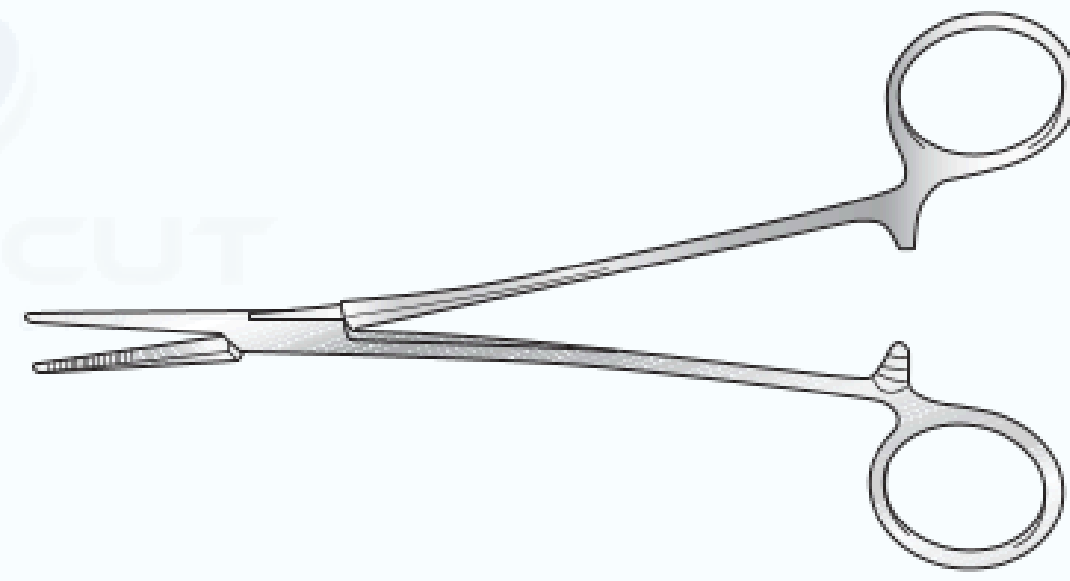

SC-ENT/151a	Straight
SC-ENT/151b	Curved

### Negus Tonsil Artery Forceps

180mm long

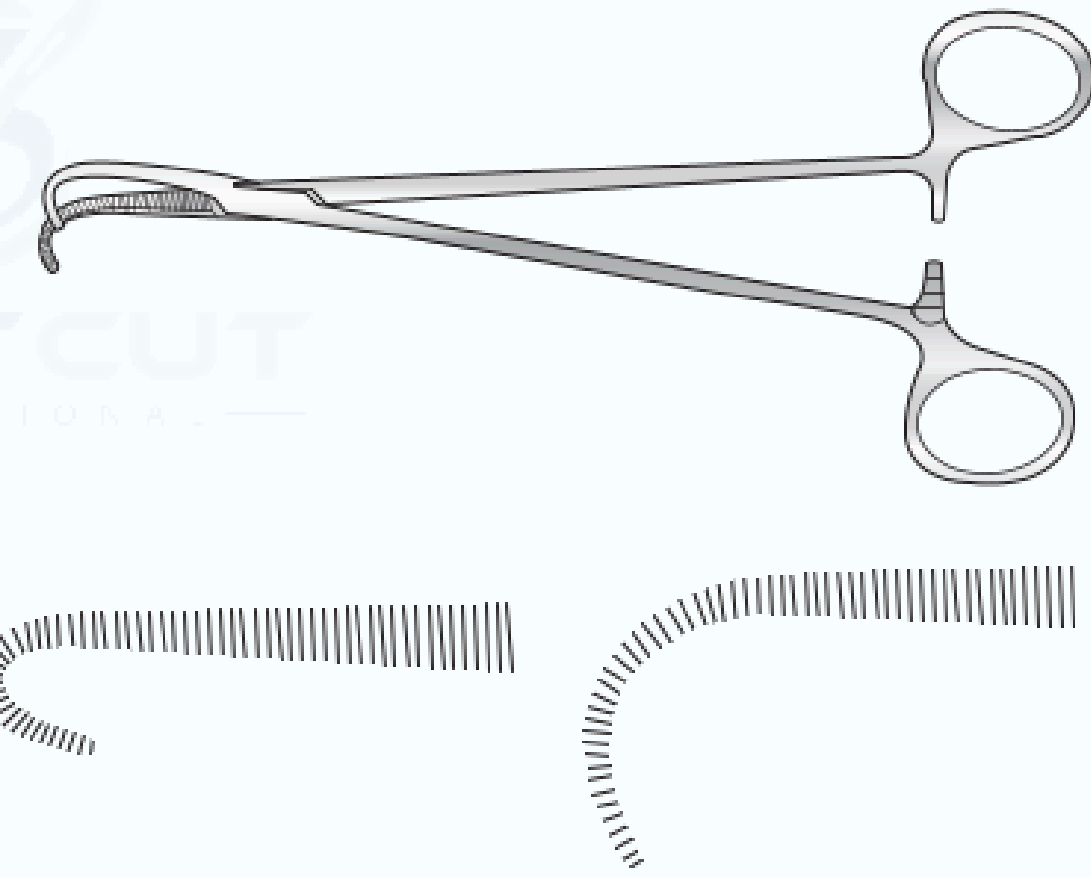

SC-ENT/197	Large curve
SC-ENT/197a	Small curve

### Denis Browne Tonsil Holding Forceps

Angled shanks, no rack

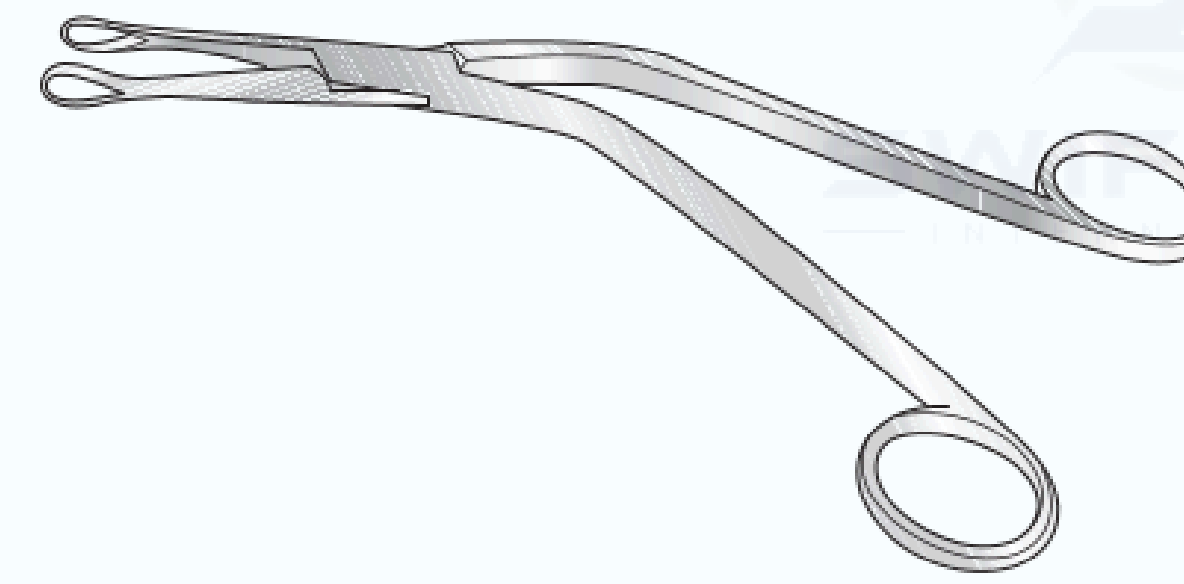

SC-ENT/144	200mm long
------------	------------

### Jansen-Middleton Nasal Septum Forceps

Compound action  
178mm long

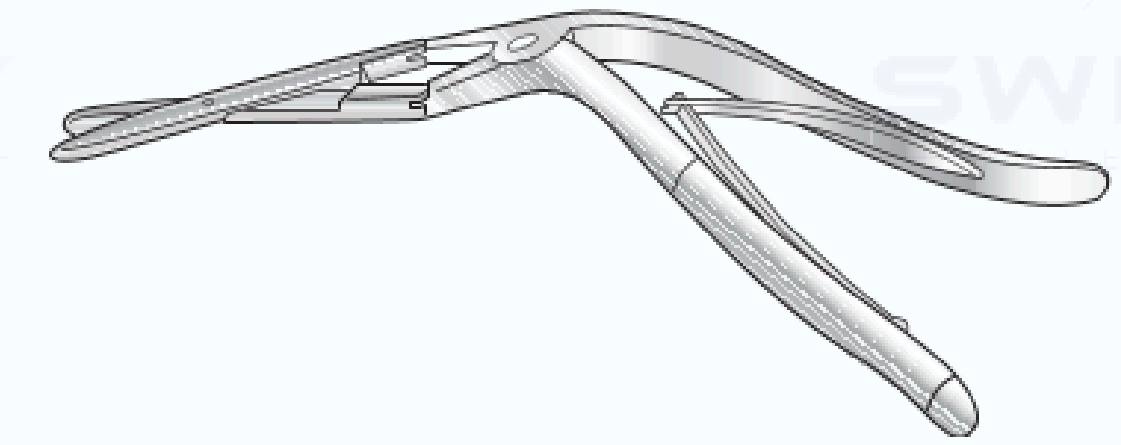

SC-PL/032	5mm jaw
-----------	---------

### Denis Browne Tonsil Artery Forceps

178mm long

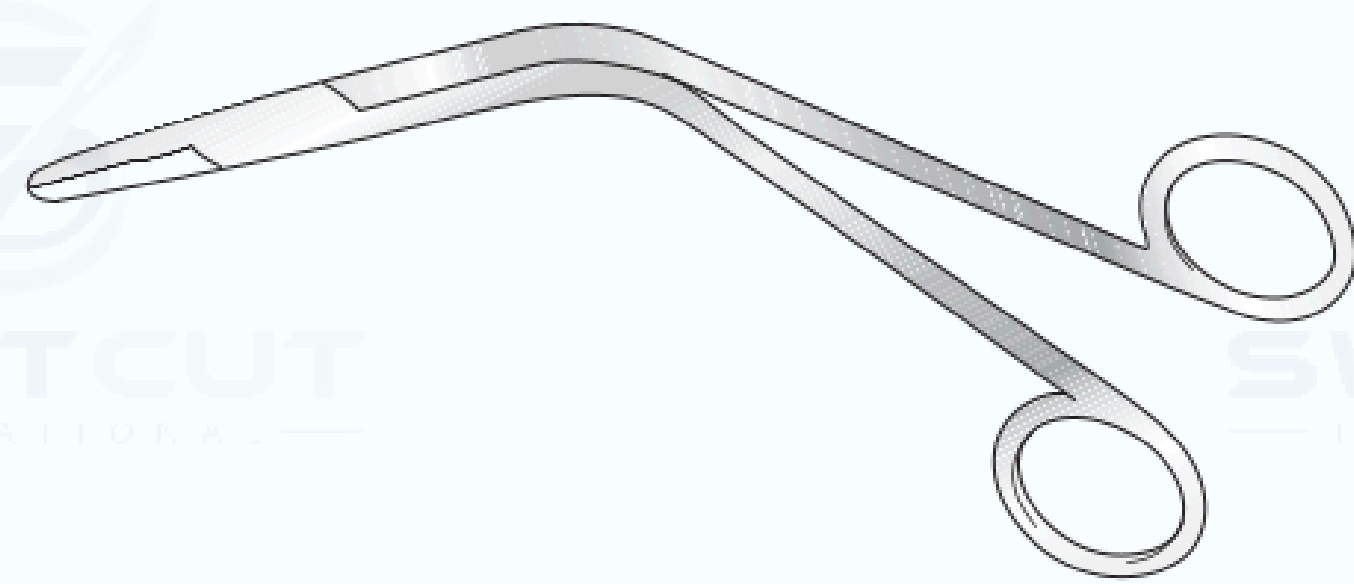

SC-ENT/155	216mm long
------------	------------

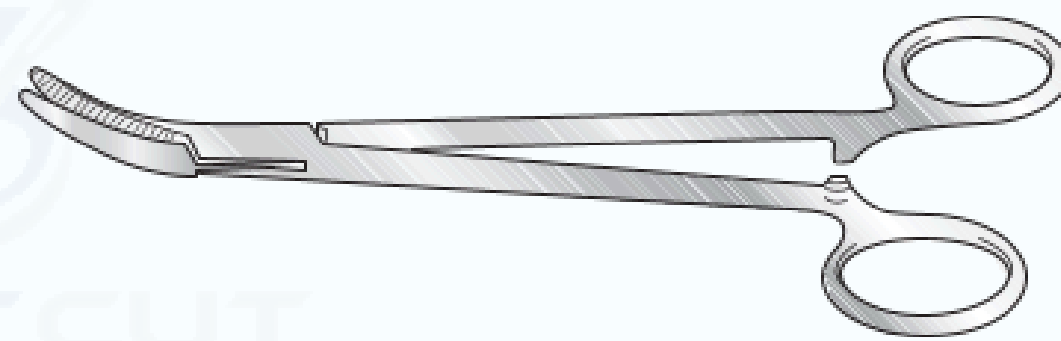

SC-ENT/152	Large curve
SC-ENT/153	Small curve

### Irwin Moore Nasal Turbinate Forceps

191mm long

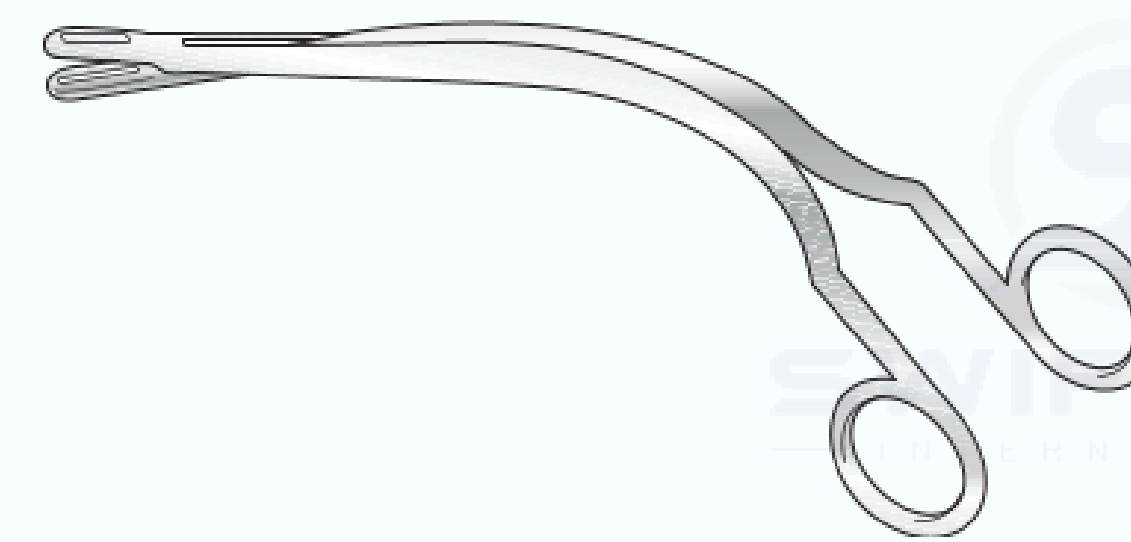

SC-ENT/077d	5mm jaw
-------------	---------

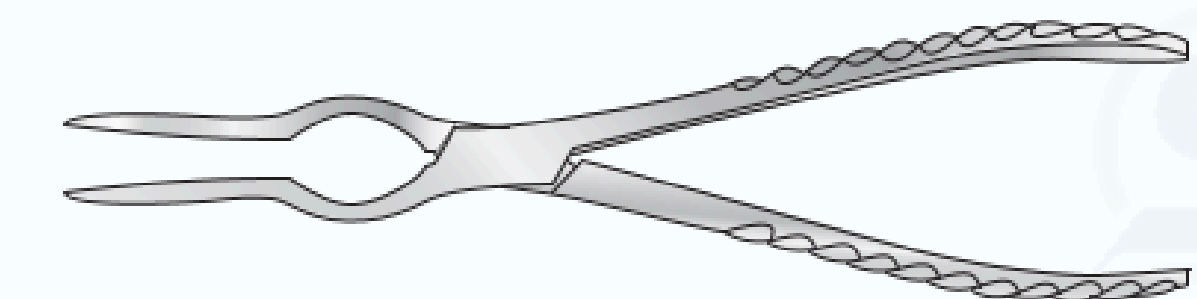

SC-PL/030a	Straight, 215mm long
SC-PL/030b	Right, 215mm long
SC-PL/030c	Left, 215mm long

### Fickling Artery Forceps

190mm long

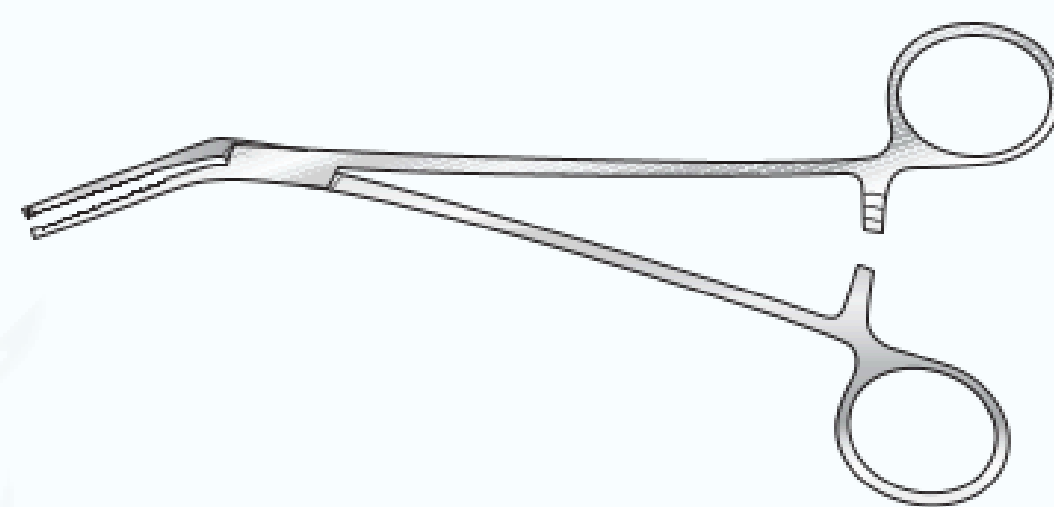

SC-PL/044b	1-2 teeth
SC-PL/044a	Serrated

### Scott Tonsil Artery Forceps

Curved to side, screw joint

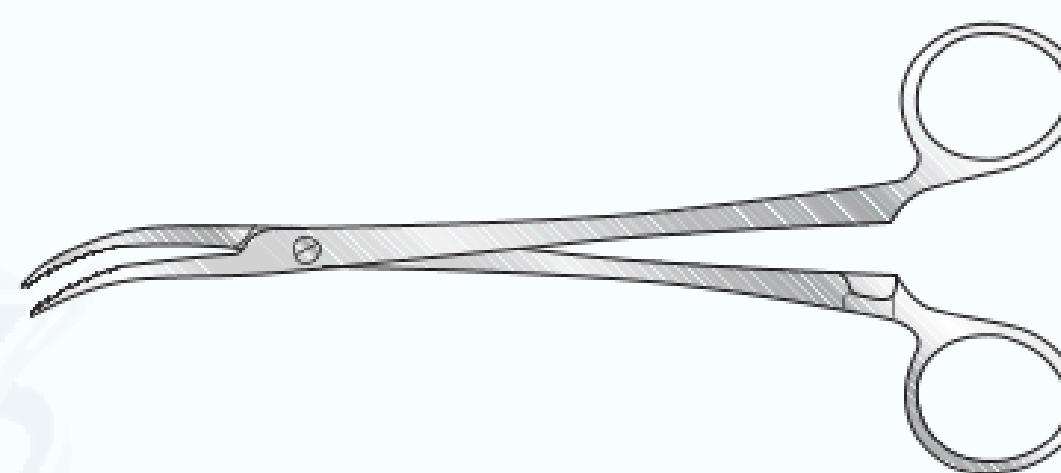

SC-ENT/154	180mm long
------------	------------

### Luc Nasal Turbinate Forceps

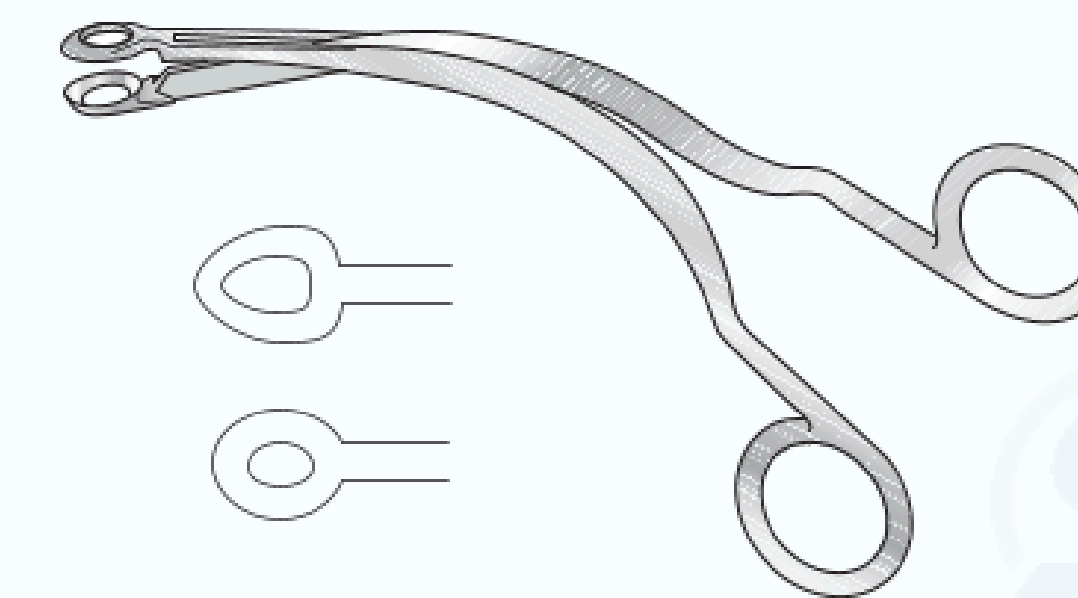

Heart shaped, 178mm long

SC-ENT/078a	Small 6mm ø
SC-ENT/078b	Medium 7.5mm ø
SC-ENT/078c	Large 9.0mm ø

Oval, 191mm long

SC-ENT/078d	Small 6mm ø
SC-ENT/078e	Medium 7.5mm ø
SC-ENT/078f	Large 9.0mm ø

### Hartmann Conchotomes

Circular cutting  
102mm to shoulder

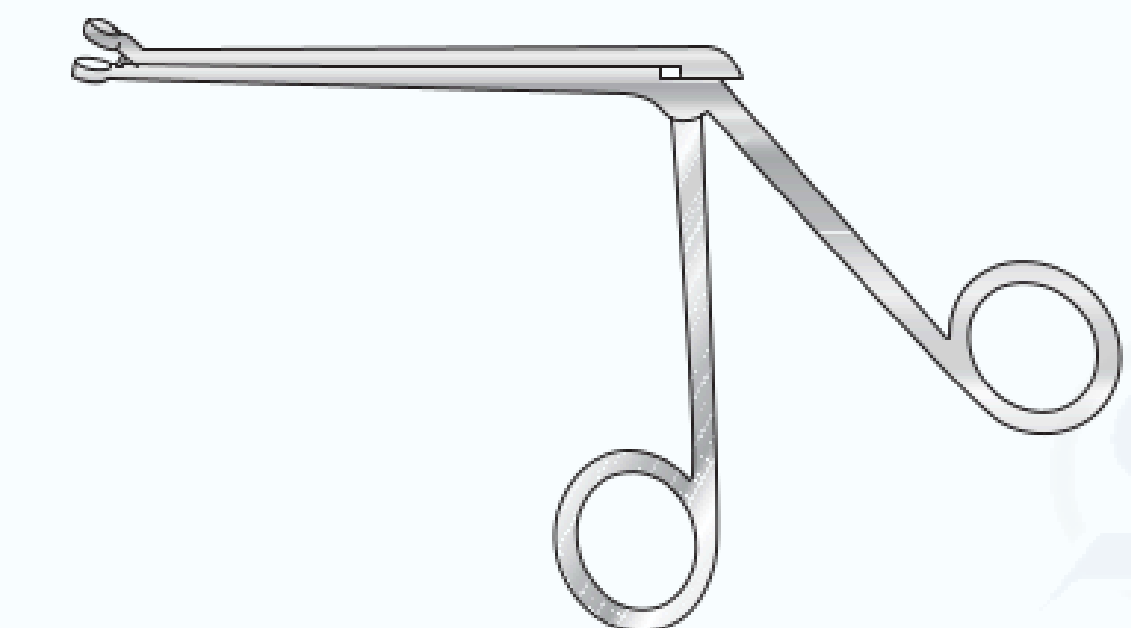

SC-ENT/080a	5mm ø
SC-ENT/080b	7mm ø
SC-ENT/080c	9mm ø
SC-ENT/080d	11mm ø

### Hartmann Dressing Forceps

Serrated jaw, screw joint

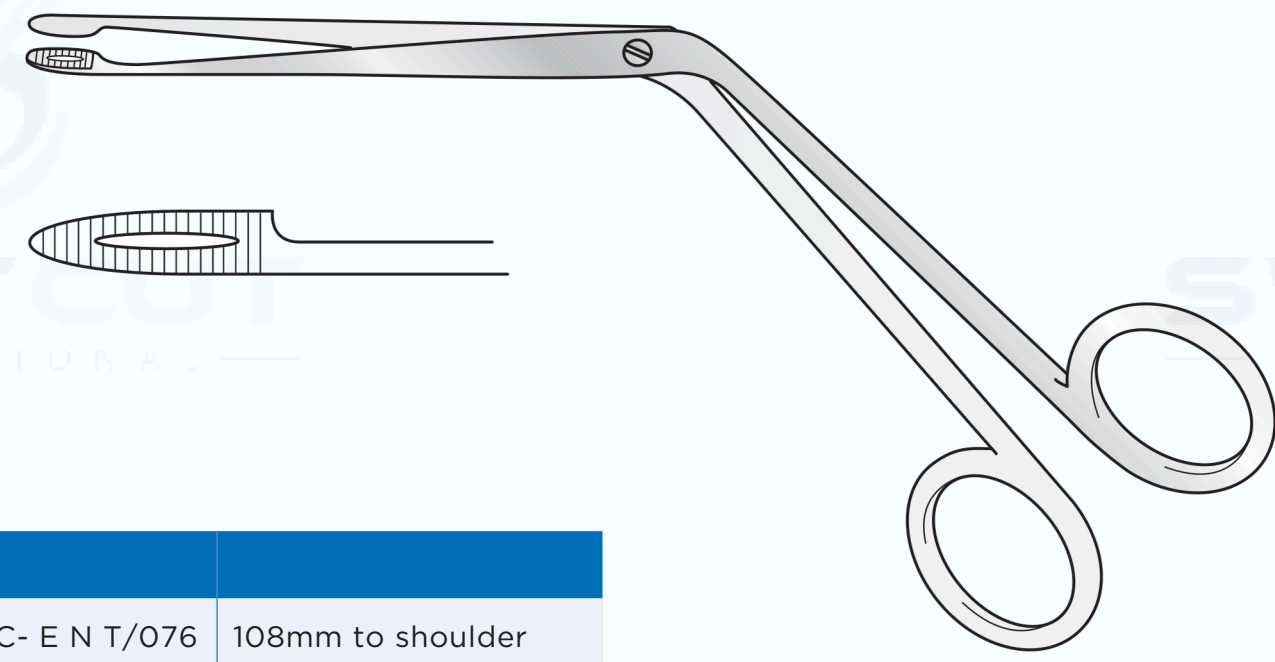

SC-ENT/076	108mm to shoulder
------------	-------------------

### Wilde Dressing Forceps

Angular, serrated jaws

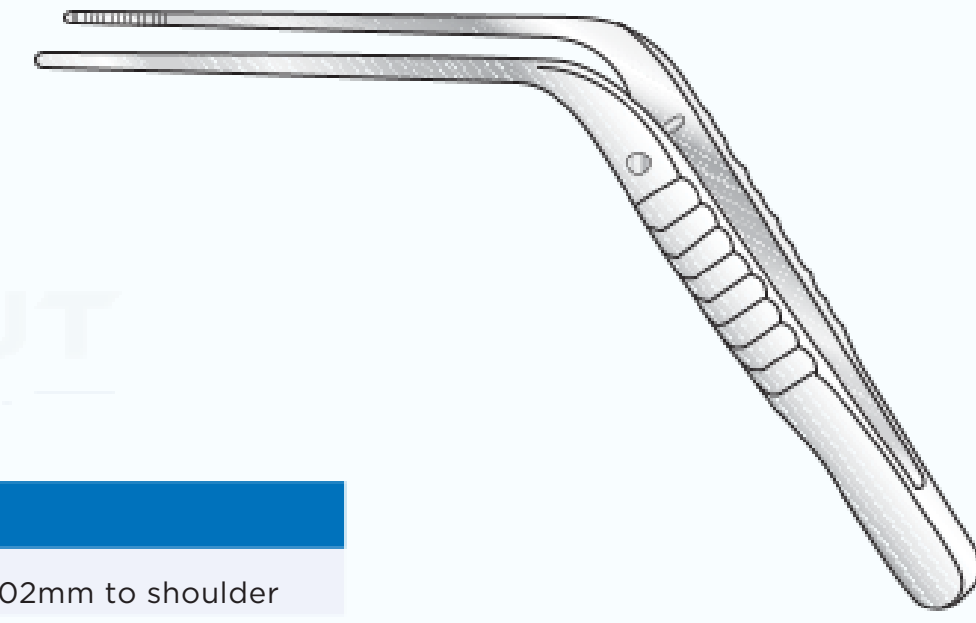

SC-ENT/075	102mm to shoulder
------------	-------------------

### Tilley Dressing Forceps

Straight, fine, serrated ends

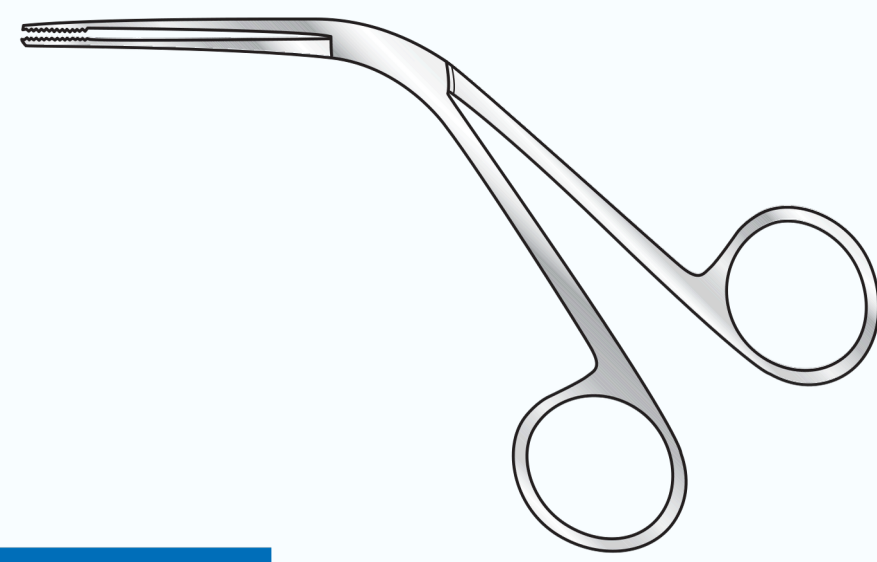

SC-ENT/077	2mm wide, 76mm to shoulder
------------	----------------------------

### Irwin Moore Thyroid Clamp

Thin jaws, angled to side

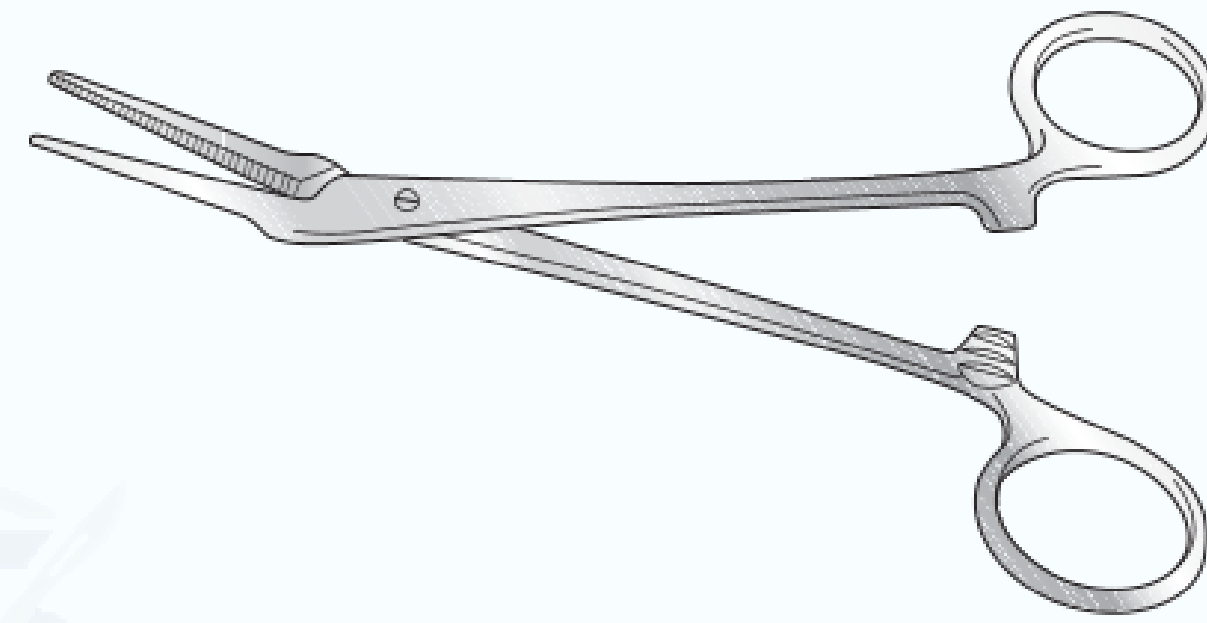

SC-ENT/170	165mm long
------------	------------

### Trousseau Tracheal Dilator

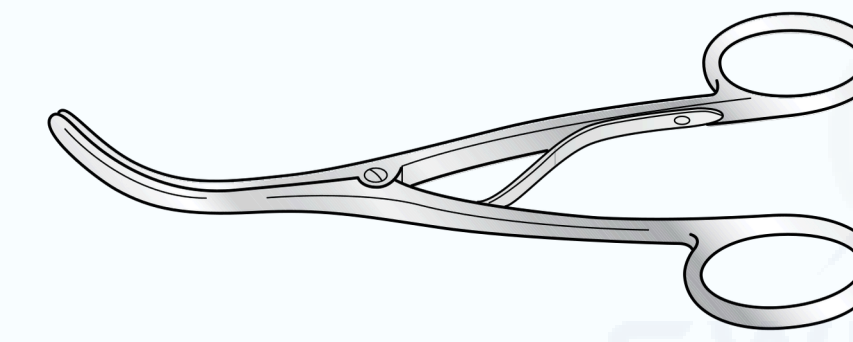

SC-ENT/172	Adult 140mm long
SC-ENT/172a	Child 125mm long

### Cawthorne Nibbling Forceps

Narrow, 3mm jaws, wide handle

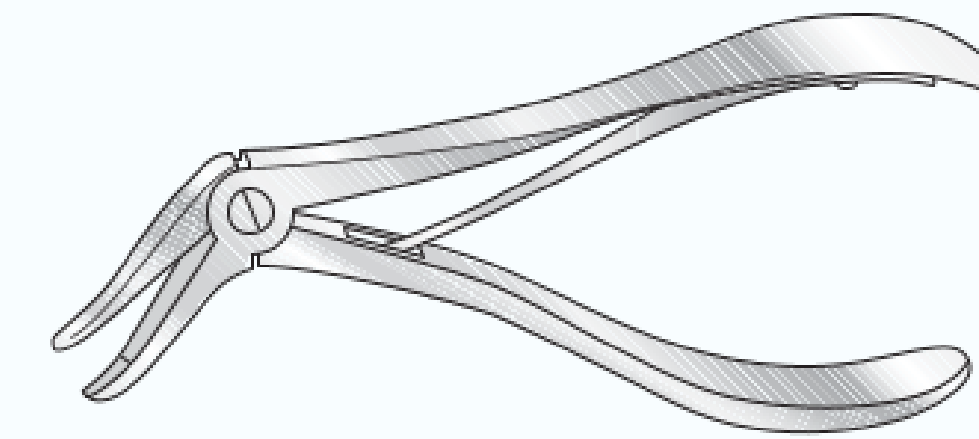

SC-ENT/068	159mm long
------------	------------

### Lempert Nibbling Forceps

152mm long

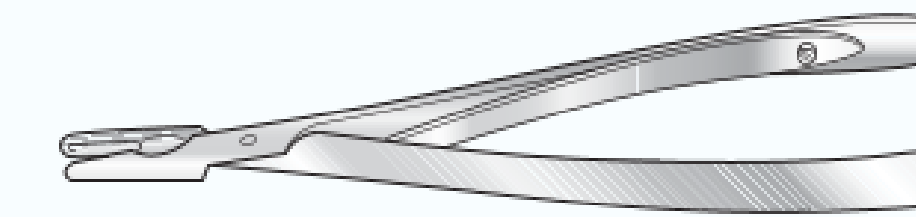

SC-ENT/067a	Straight, 2.5mm jaws
SC-ENT/067b	Angled, 3.0mm jaws

### Wilson Bone Nibbling Forceps

Fine, curved, satin finish  
152mm long

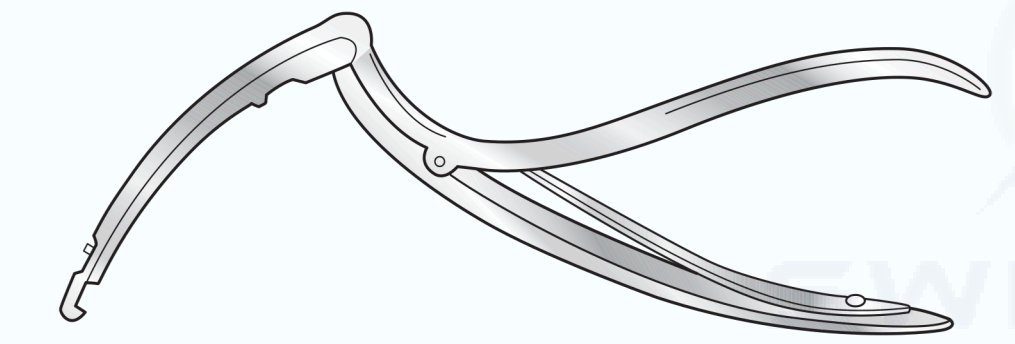

SC-ENT/054	Downward cutting - 3mm jaws
SC-ENT/055	Upward cutting - 3mm jaws

### Denis Browne Collar Crushing Forceps

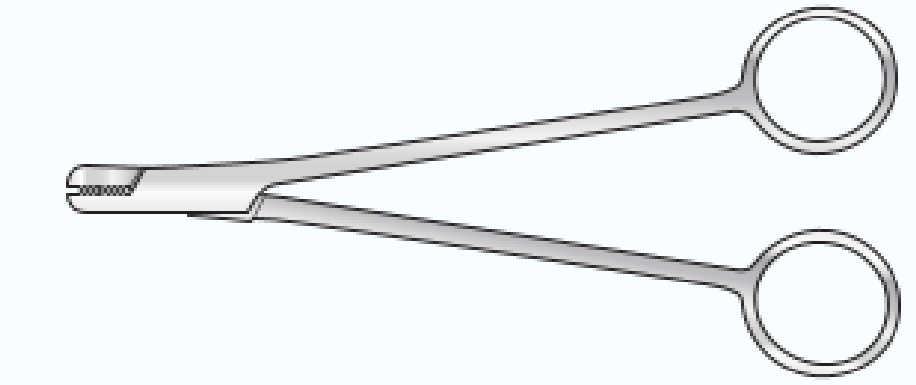

SH-4062	140mm long
---------	------------

### Doyen Mouth Gag

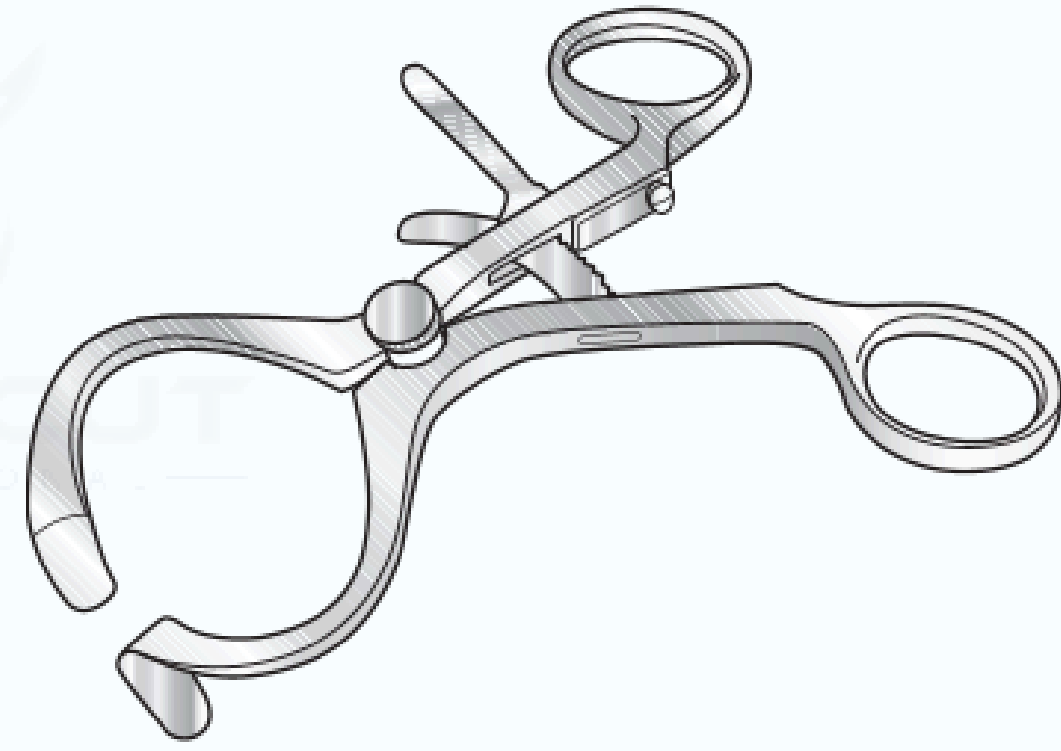

SC-ENT/88d	Adult
SC-ENT/88e	Child

### Boyle-Davis Mouth Gag

Frame only

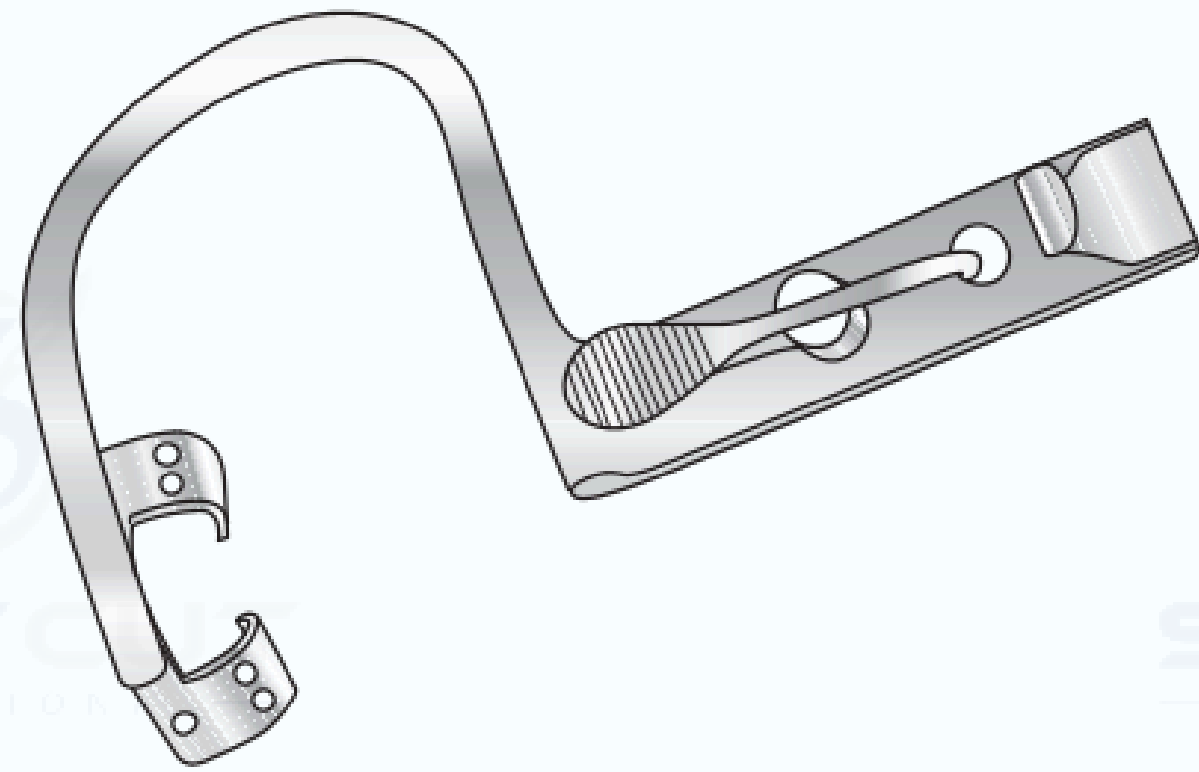

SC-ENT/083a	Adult
SC-ENT/083b	Child

### Kilner Dott Mouth Gag

Frame only

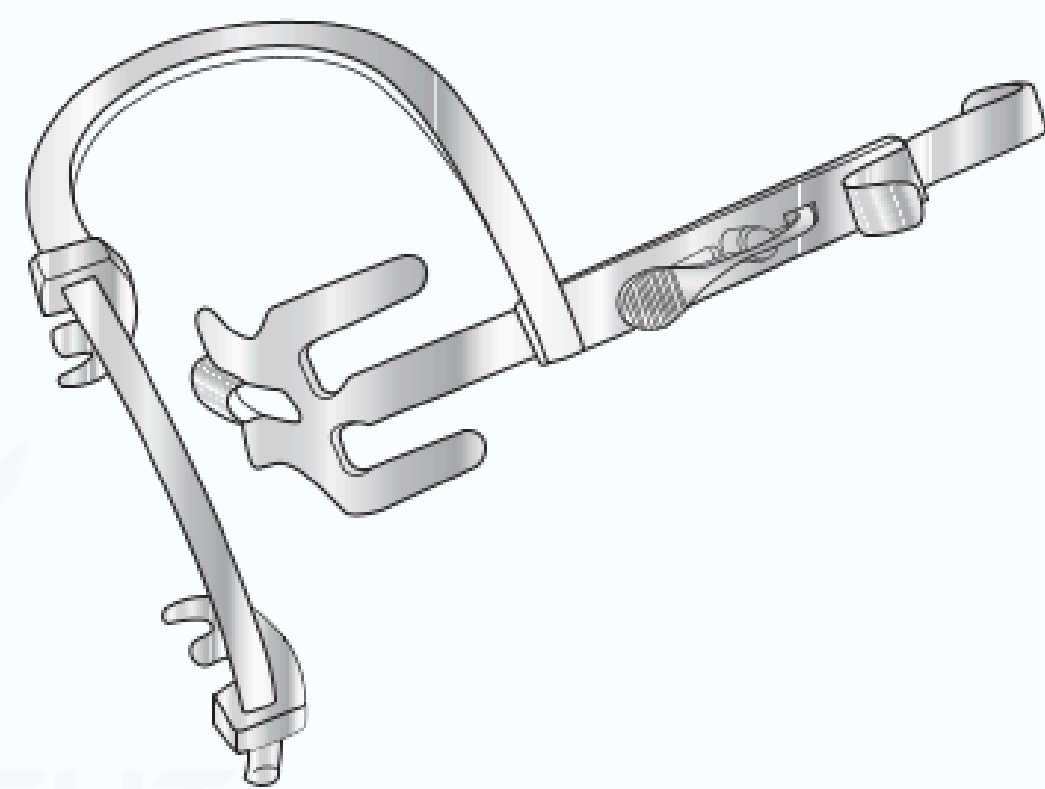

SC-ENT/087a	Adult
SC-ENT/088e	Set, including frame, small, medium, and large blades

### Fergusson Ackland Mouth Gag

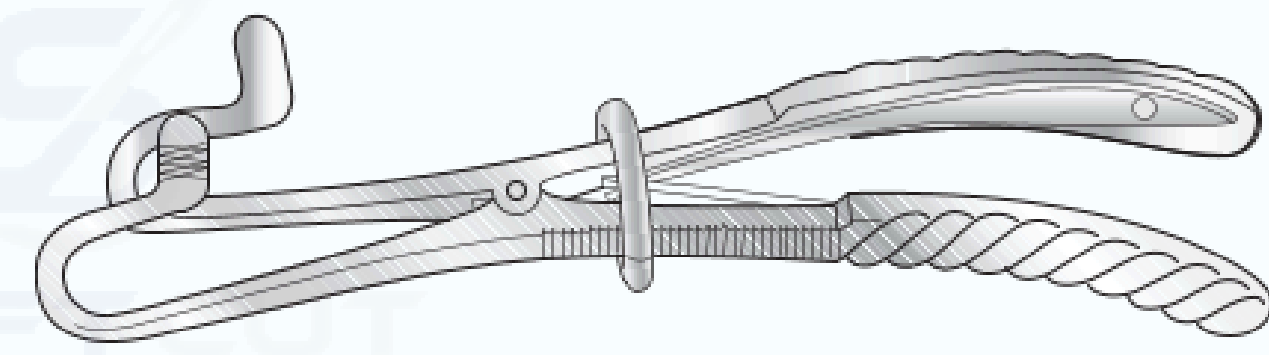

SC-ENT/209	Adult, 210mm
SC-ENT/209a	Child, 155mm

### Mason Mouth Gag

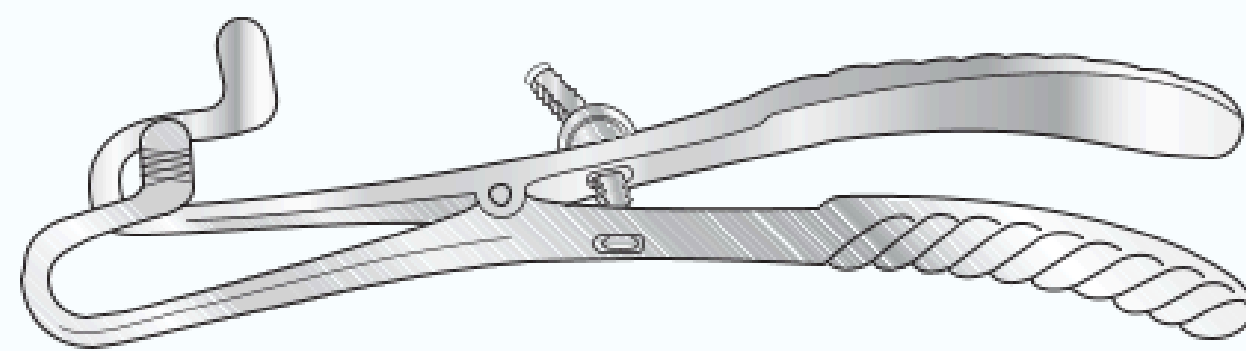

SC-ENT/210	Adult, 210mm
------------	--------------

### Draffin Bipod

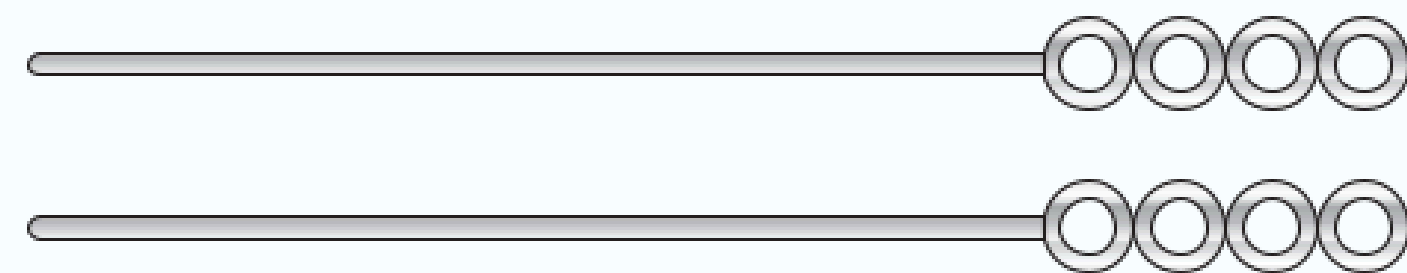

#### Adult

SC-ENT/083	Adult, 4 hole x 480mm long half circle end for use with a drape
SC-ENT/083E	Adult, 4 hole x 480mm long with round ends to be used with Magauran plate
SC-ENT/083E	Adult, 4 hole x 480mm long with round ends to be used with Magauran plate

#### Child

SC-ENT/083C	Child, 3 hole x 425mm long half circle end for use with a drape
SC-ENT/083D	Child, 3 hole x 425mm long with round ends to be used with Magauran plate
SC-ENT/083F	Child, 4 hole x 425mm long with round ends to be used with Magauran plate Alder Hey Children's Hospital pattern
SC-ENT/083D	Child, 3 hole x 425mm long with round ends to be used with Magauran plate
SC-ENT/083F	Child, 4 hole x 425mm long with round ends to be used with Magauran plate Alder Hey Children's Hospital pattern
SH-5104	Magauran plate 480mm - for use with Draffin bipods

#### Magauran Plate

SH-5104	480mm - for use with Draffin bipods
---------	-------------------------------------

### Doughty Tongue Plate

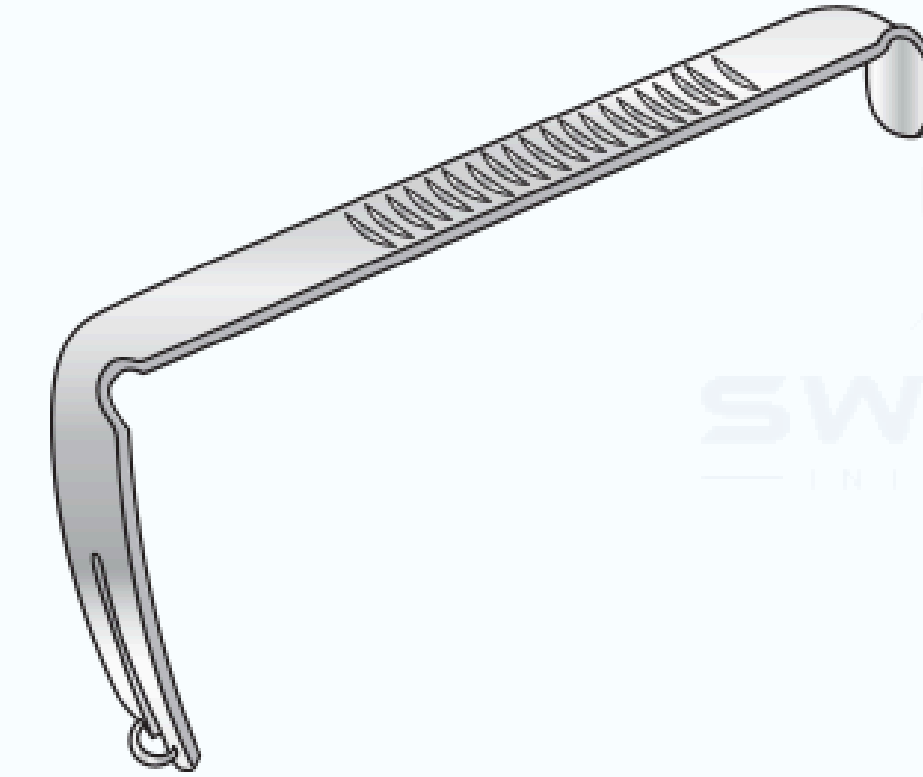

#### Plain

SC-ENT/084a	65mm - 1.6mm-1.9mm slot
SC-ENT/084b	75mm - 1.6mm-1.9mm slot
SC-ENT/084c	90mm - 4mm-4.5mm slot
SC-ENT/084d	100mm - 4mm-4.5mm slot
SC-ENT/084e	115mm - 4mm-4.5mm slot

#### Slotted

SC-ENT/085a	65mm - 1.6mm-1.9mm slot
SC-ENT/085b	75mm - 1.6mm-1.9mm slot
SC-ENT/085c	90mm - 4mm-4.5mm slot
SC-ENT/085d	100mm - 4mm-4.5mm slot
SC-ENT/085e	115mm - 4mm-4.5mm slot

#### With anaesthetic tube

SC-ENT/086a	65mm - 1.6mm-1.9mm slot
SC-ENT/086b	75mm - 1.6mm-1.9mm slot
SC-ENT/086c	90mm - 4mm-4.5mm slot
SC-ENT/086d	100mm - 4mm-4.5mm slot
SC-ENT/086e	115mm - 4mm-4.5mm slot

### Kilner Dott Tongue Plate

With endotrachealtube groove

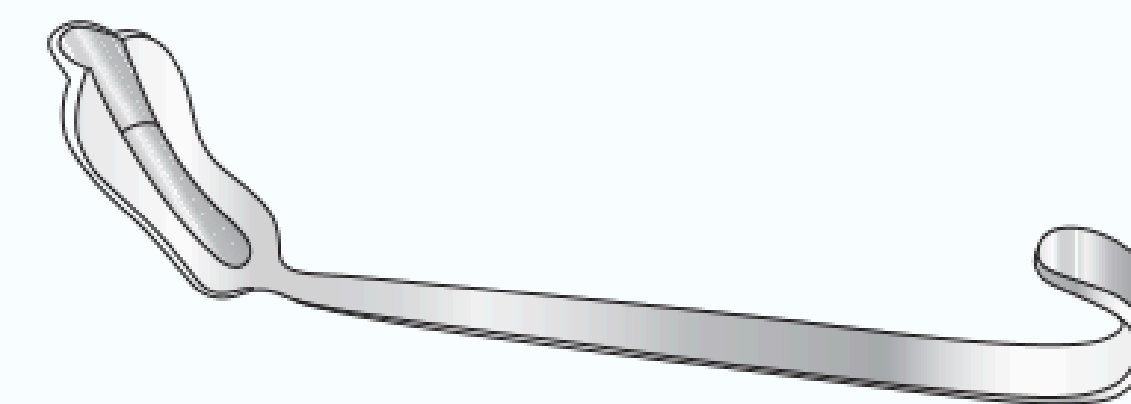

SC-ENT/088a	Small
SC-ENT/088b	Medium
SC-ENT/088c	Large
SC-ENT/088d	Extra small

### Tongue Depressor

Flat stainless steel

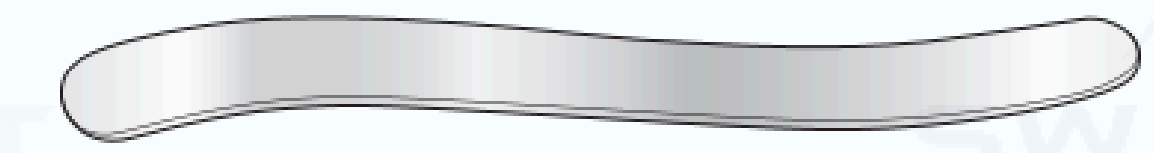

SC-ENT/143	184mm long
------------	------------

### Lack Tongue Depressor

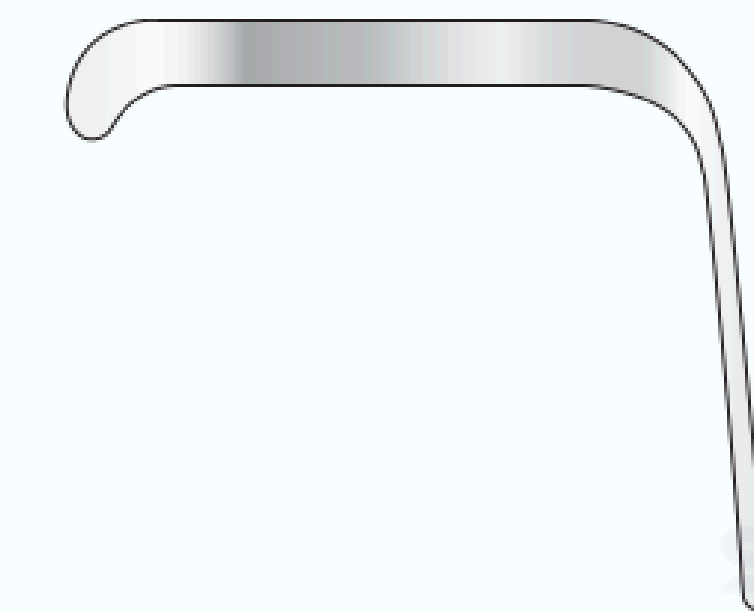

SC-ENT/142a	Child, 13mm wide
SC-ENT/142b	Adolescent, 19mm wide
SC-ENT/142c	Adult, 22mm wide

### Nasal Cutting Forceps

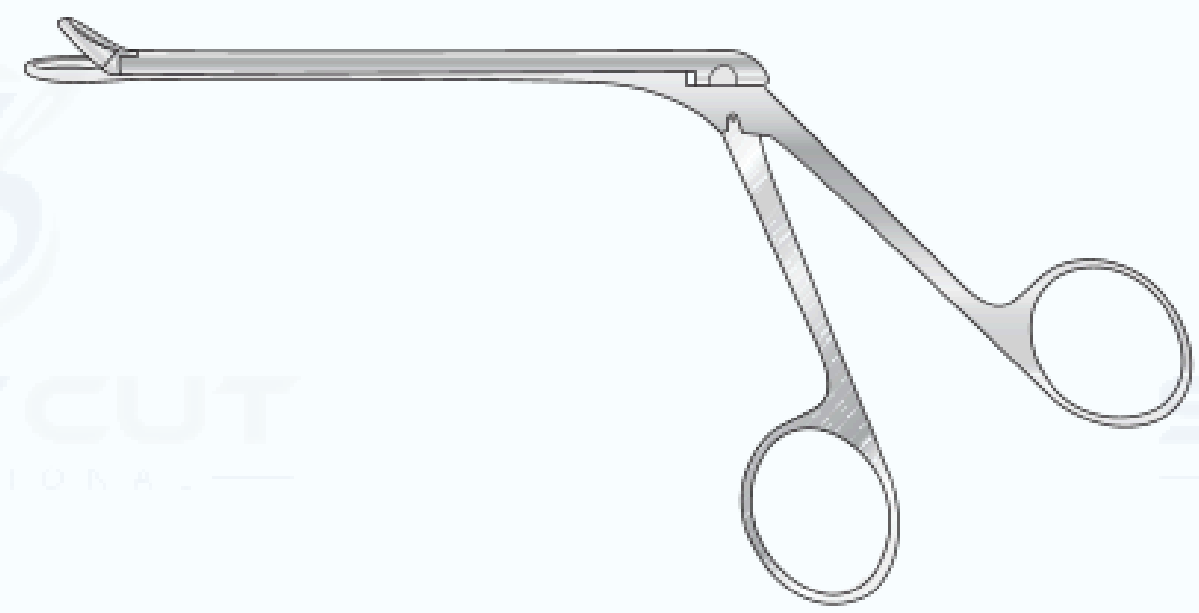

#### Myles

Through cutting, 120mm to shoulder

SC-ENT/SH5889	12.5 x 3.5mm jaw
---------------	------------------

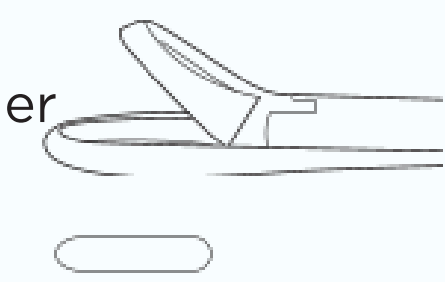

#### Gruenwald-Henke

Throughcutting, 120mm to shoulder

SC-ENT/SH5281	7 x 2mm jaw
SC-ENT/SH5282	9 x 2.5mm jaw

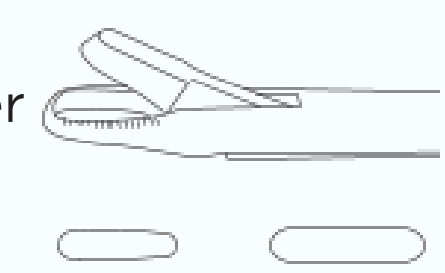

#### St ruycke n

Throughcutting, 120mm to shoulder

SC-ENT/SH5280	11 x 1mm jaw
---------------	--------------

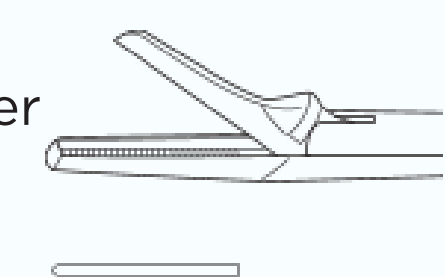

### Grunwald Nasal Punch Forceps

108mm to shoulder

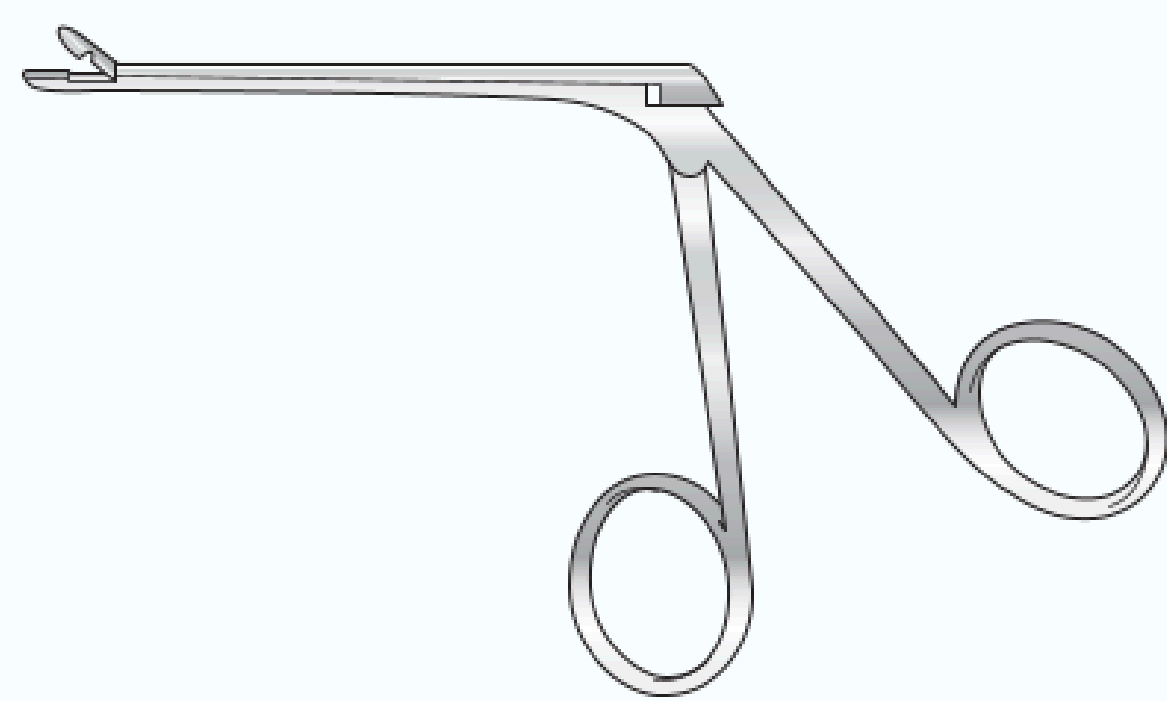

SC-ENT/077a	A fenestrated jaw, 3.5mm
SC-ENT/077b	Fenestrated lower jaw, narrow, 2.5mm
SC-ENT/077c	Fenestrated and tapered lower jaw, 2-3mm

### Seymour Jones Antrum Punch Forceps

159mm long

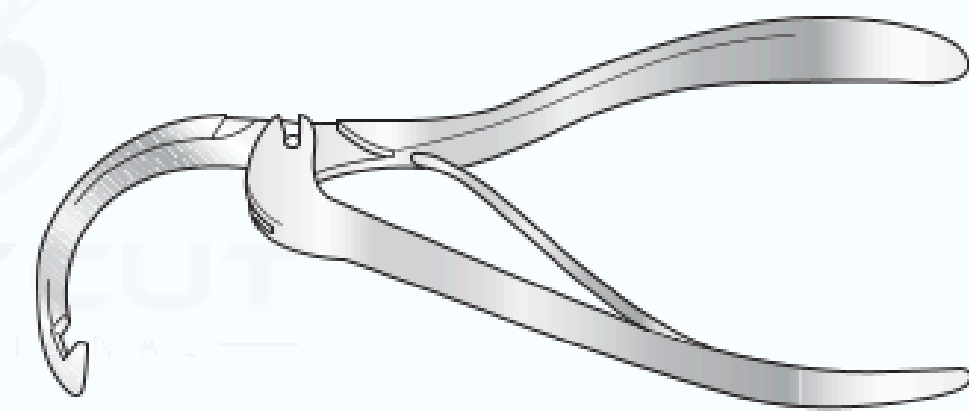

SC-ENT/132	4mm jaw
------------	---------

### Backbiter

180mm long

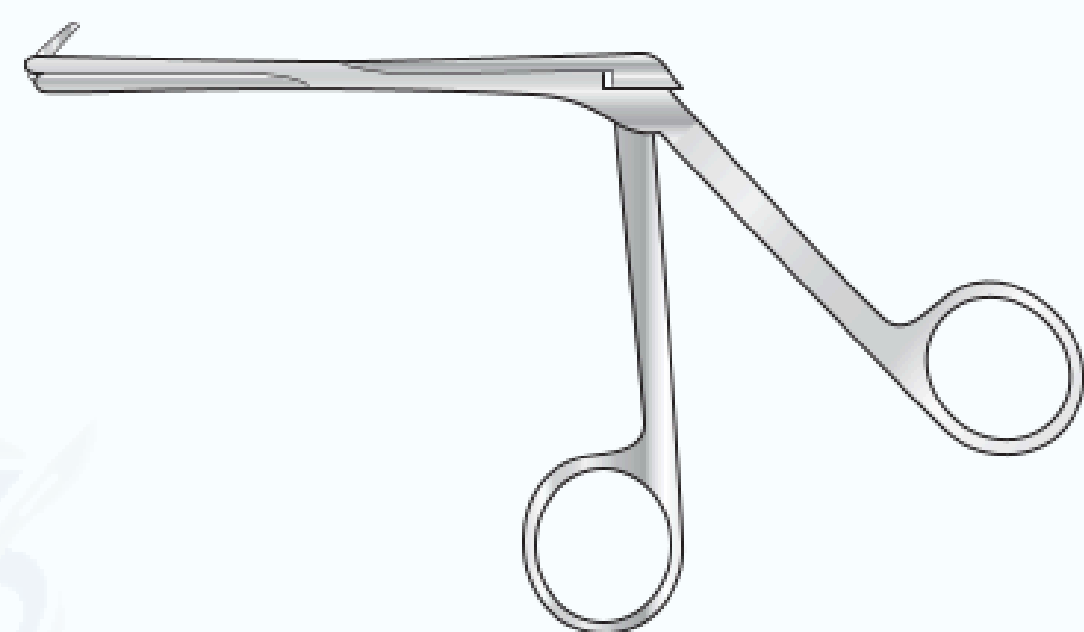

SH/4765b	7 x 3mm jaw
----------	-------------

### Backbiter

200mm long

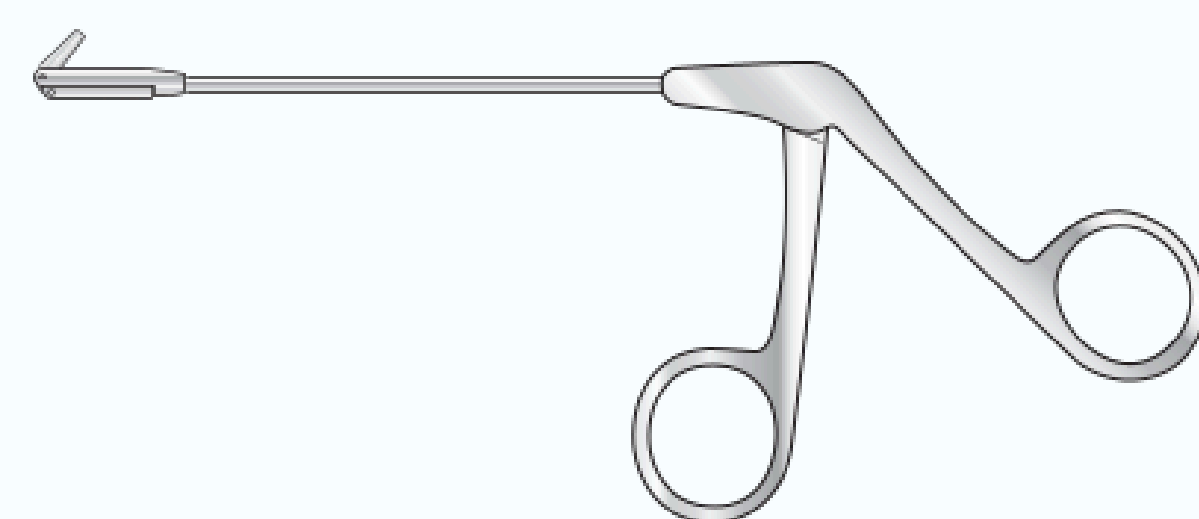

SC-ENT/5392	7 x 2mm jaw
-------------	-------------

### Stammberger Rhinoforcep Antrium Punch

7mm x 3mm, 130mm long

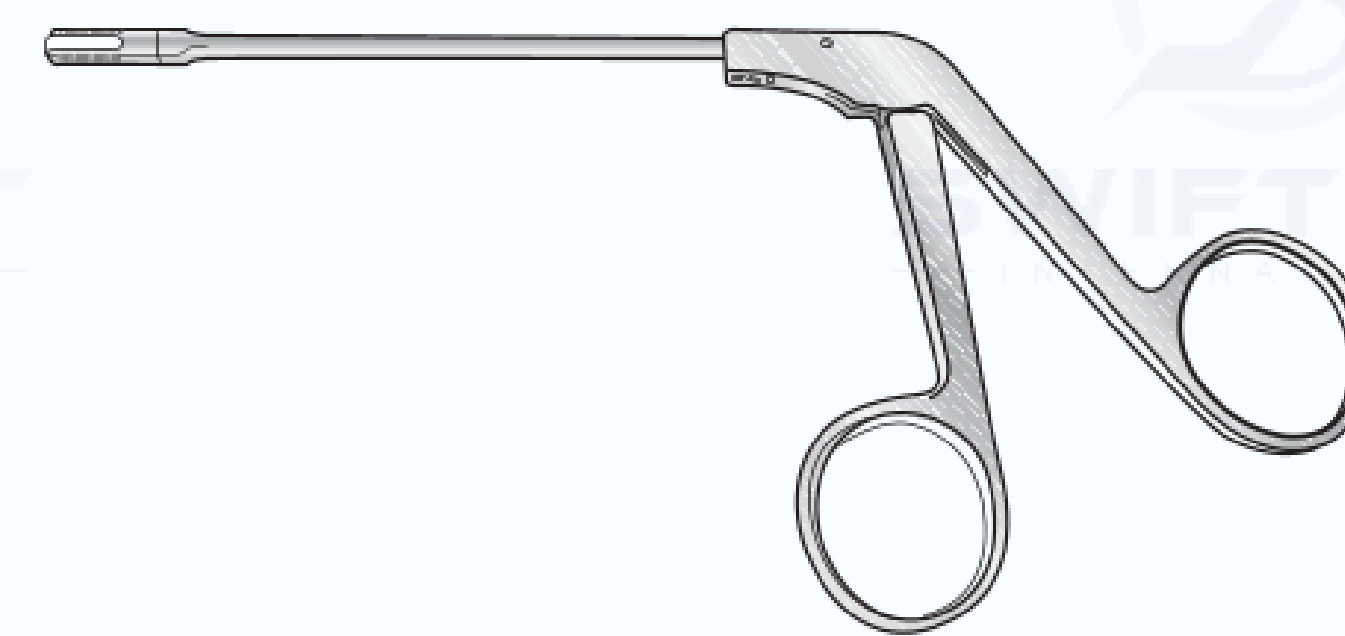

SC-ENT/234	Left back cut
SC-ENT/234a	Right back cut

### Ostrom Antrum Punch

Forcep, 178mm to shoulder

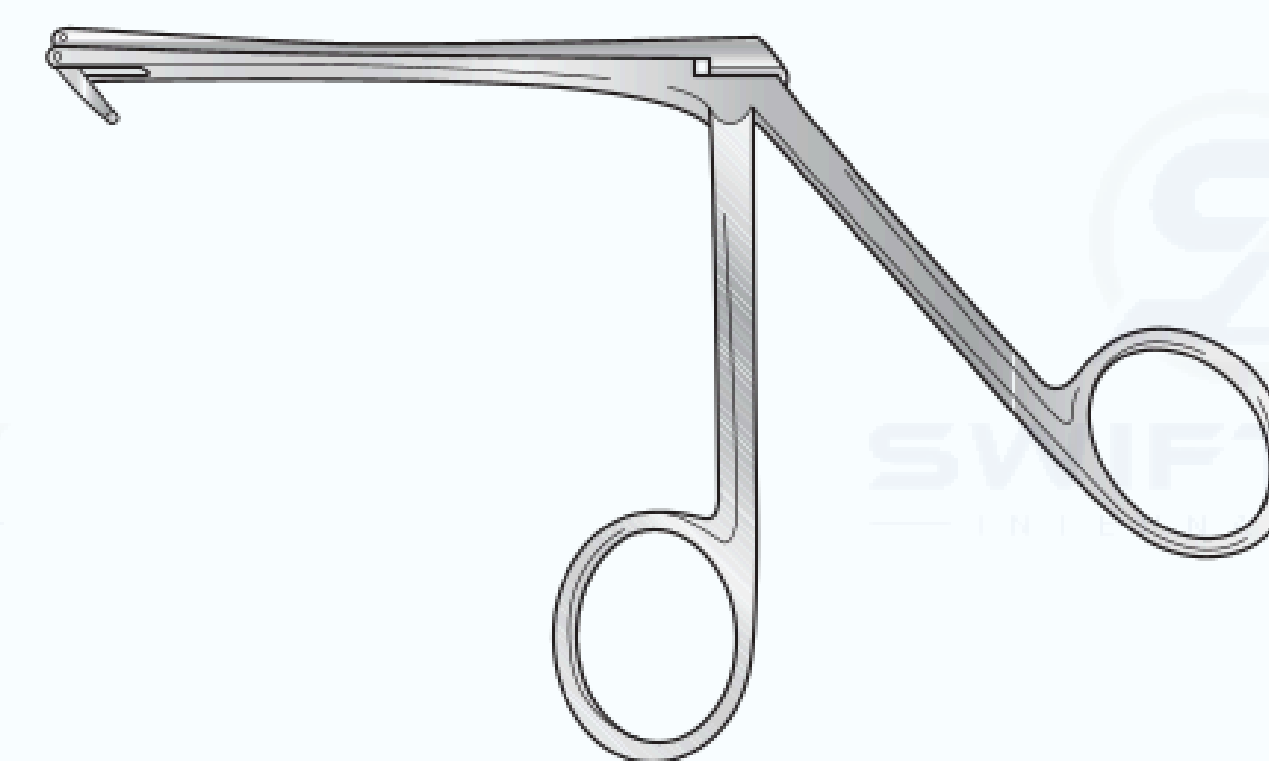

SC-ENT/135	3mm jaw
------------	---------

### Paterson Biopsy Forceps

Elongated cup, 3mm jaw



SC-ENT/174a	305mm long
SC-ENT/174b	355mm long
SC-ENT/174c	406mm long
SC-ENT/174d	508mm long

### Tilley Henckel Ethmoid Punch

Graduated shank, 114mm to shoulder

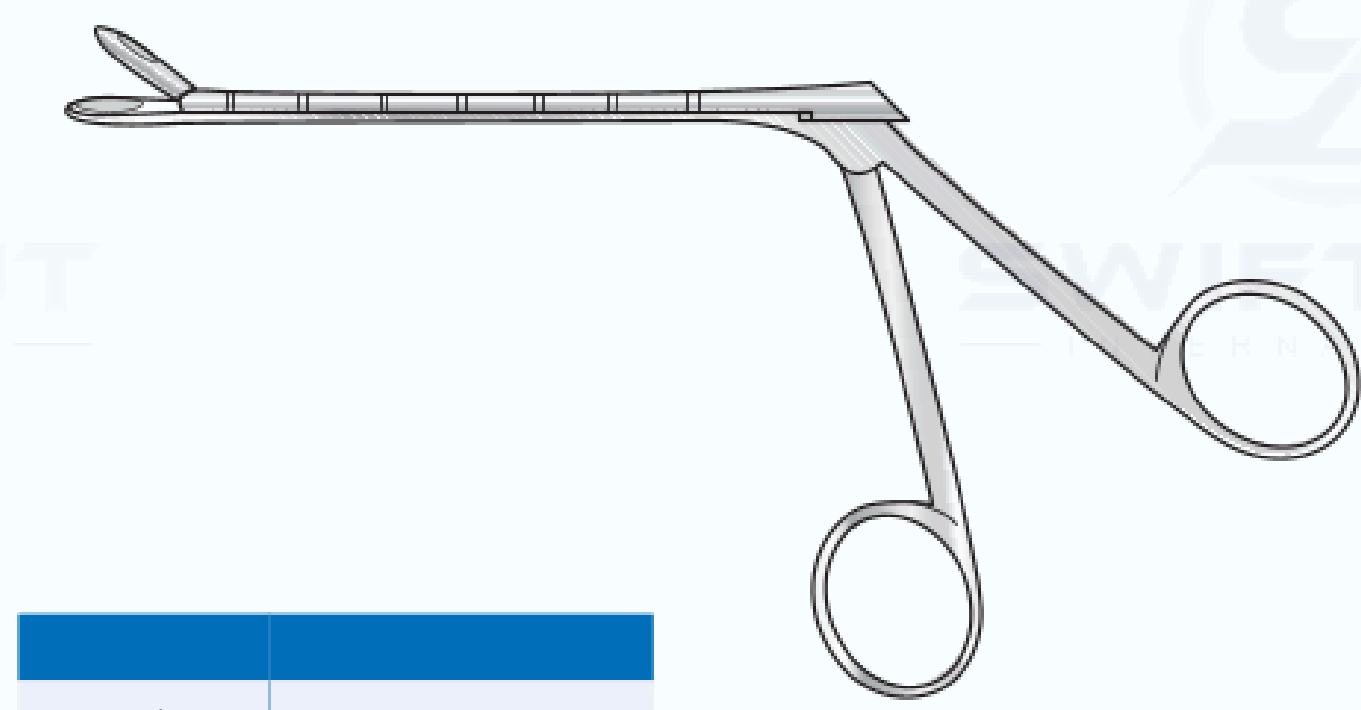

SC-ENT/138a	4.5mm
SC-ENT/138b	5.5mm
SC-ENT/138c	6.5mm
SC-ENT/138d	8mm

### Mackay Modified Stammberger Punch

200mm long

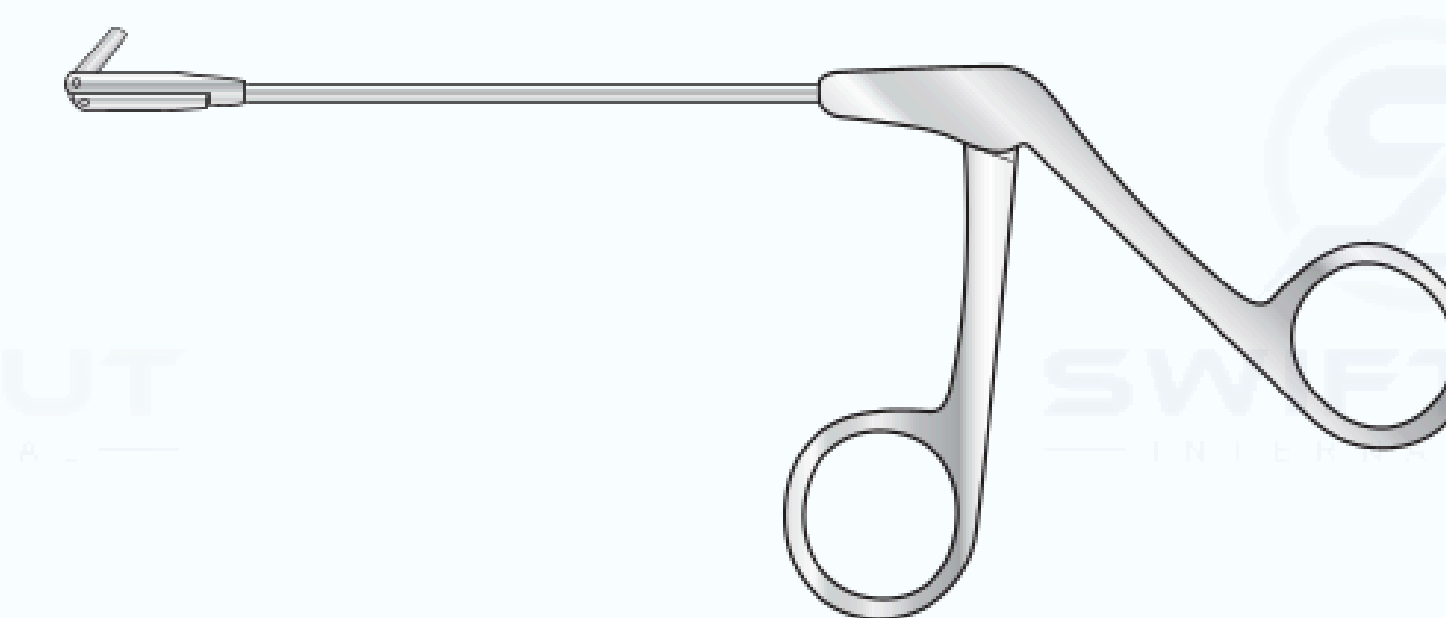

SC-ENT/5392	7 x 2mm jaw
-------------	-------------

### Chevalier Jackson Endoscope Forcep

With crocodile action and serrated jaw

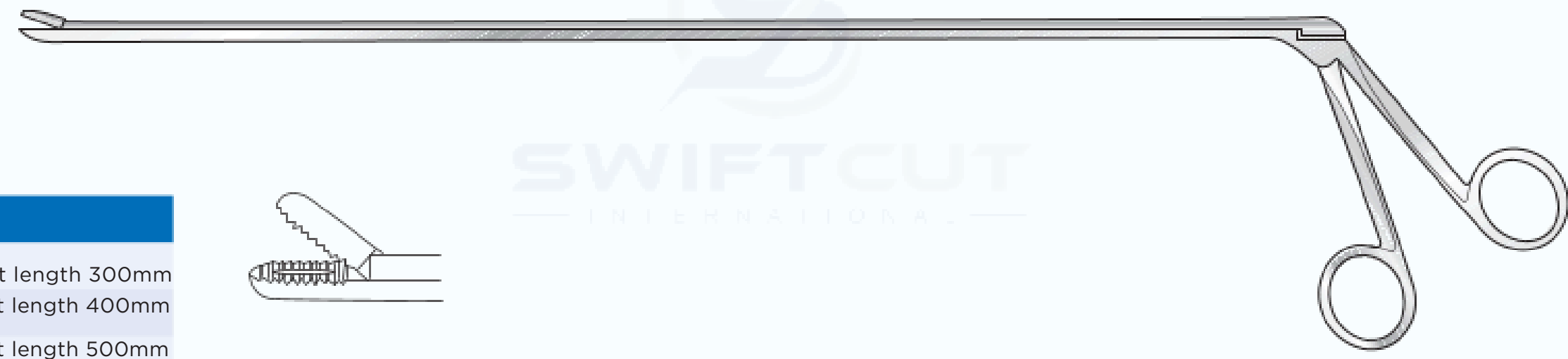

SC-ENT/241	Effective shaft length 300mm
SC-ENT/242	Effective shaft length 400mm
SC-ENT/243	Effective shaft length 500mm
SC-ENT/244	Effective shaft length 600mm

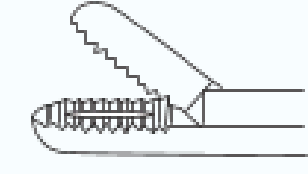

### Chevalier Jackson Vocal Nodule Endoscope Forcep

With crocodile action and curved cup

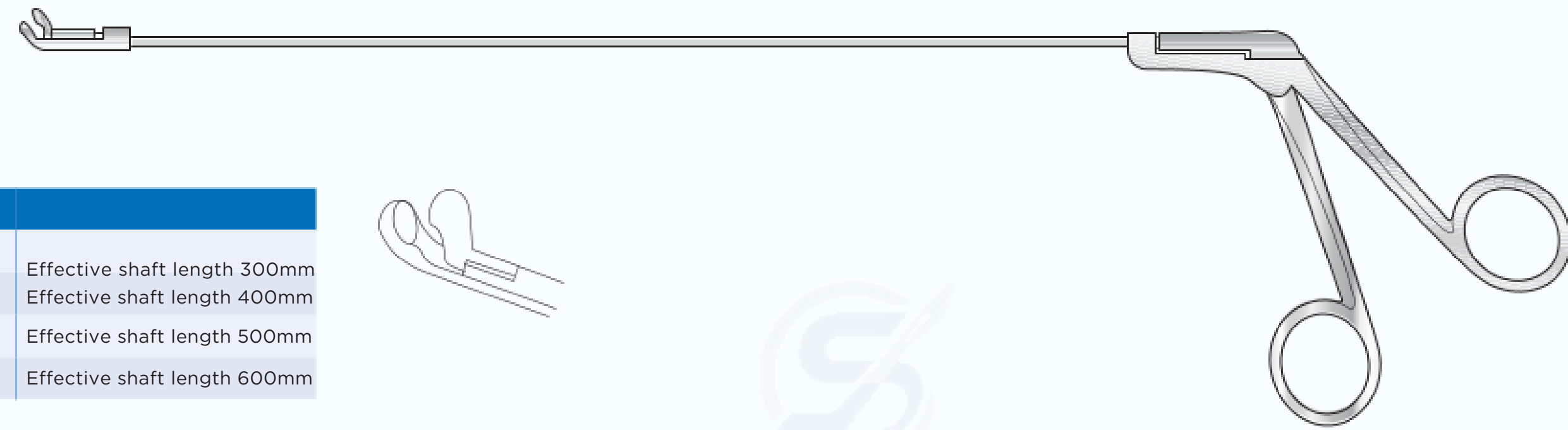

SC-ENT/245	Effective shaft length 300mm
SC-ENT/246	Effective shaft length 400mm
SC-ENT/247	Effective shaft length 500mm
SC-ENT/248	Effective shaft length 600mm

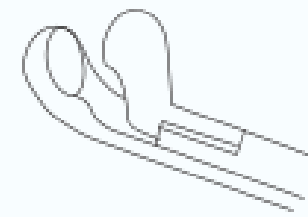

### Chevalier Jackson Vocal Nodule Endoscope Forcep

With crocodile action and straight cup



SC-ENT/249	Effective shaft length 300mm
SC-ENT/250	Effective shaft length 400mm
SC-ENT/251	Effective shaft length 500mm
SC-ENT/252	Effective shaft length 600mm

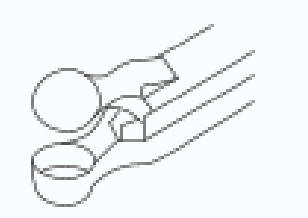

### St Bartholomew's Ethmoid Punch

Scoop blades, 3mm bite, 114mm to shoulder

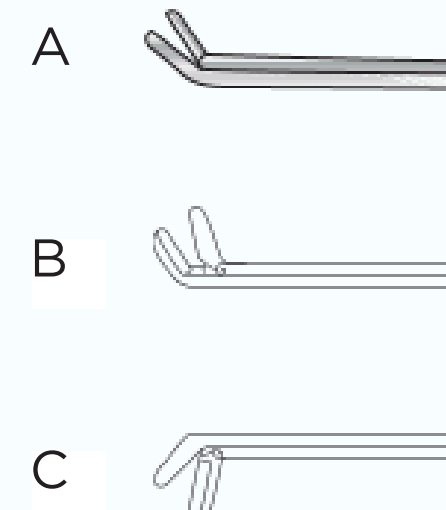

SC-ENT/140a	Straight
SC-ENT/140b	Upward cutting
SC-ENT/140c	Downward cutting

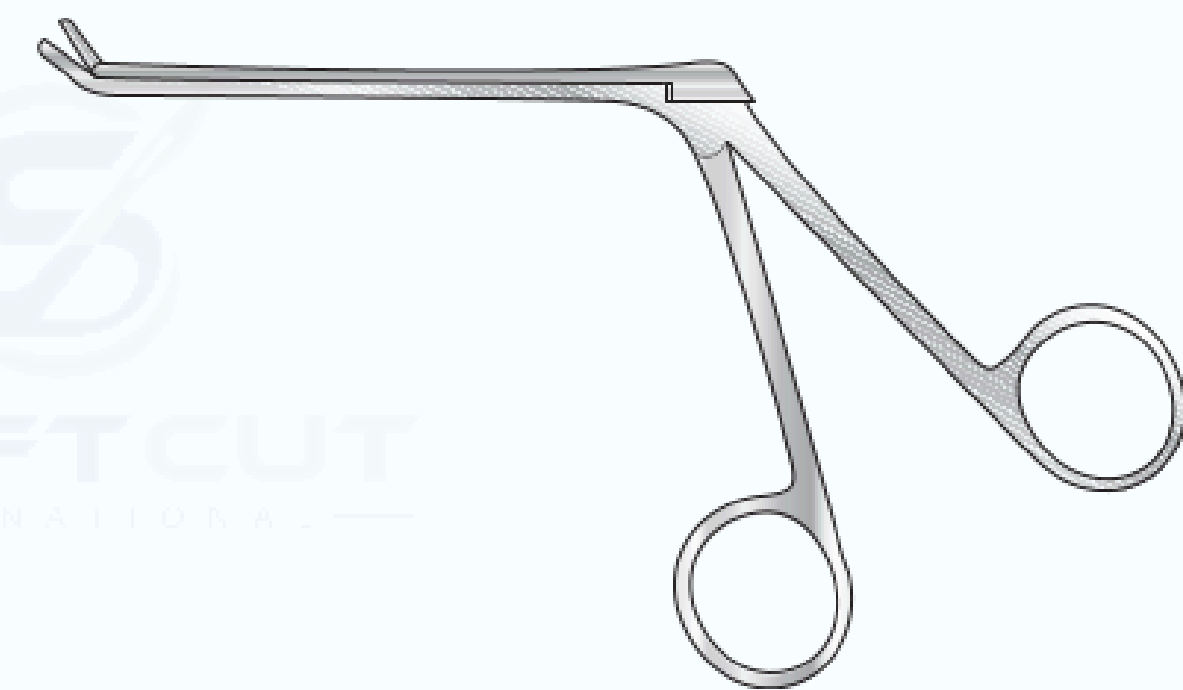

### Ferris Smith Kerrison Punch

Heavy, 5mm bite, 229mm long

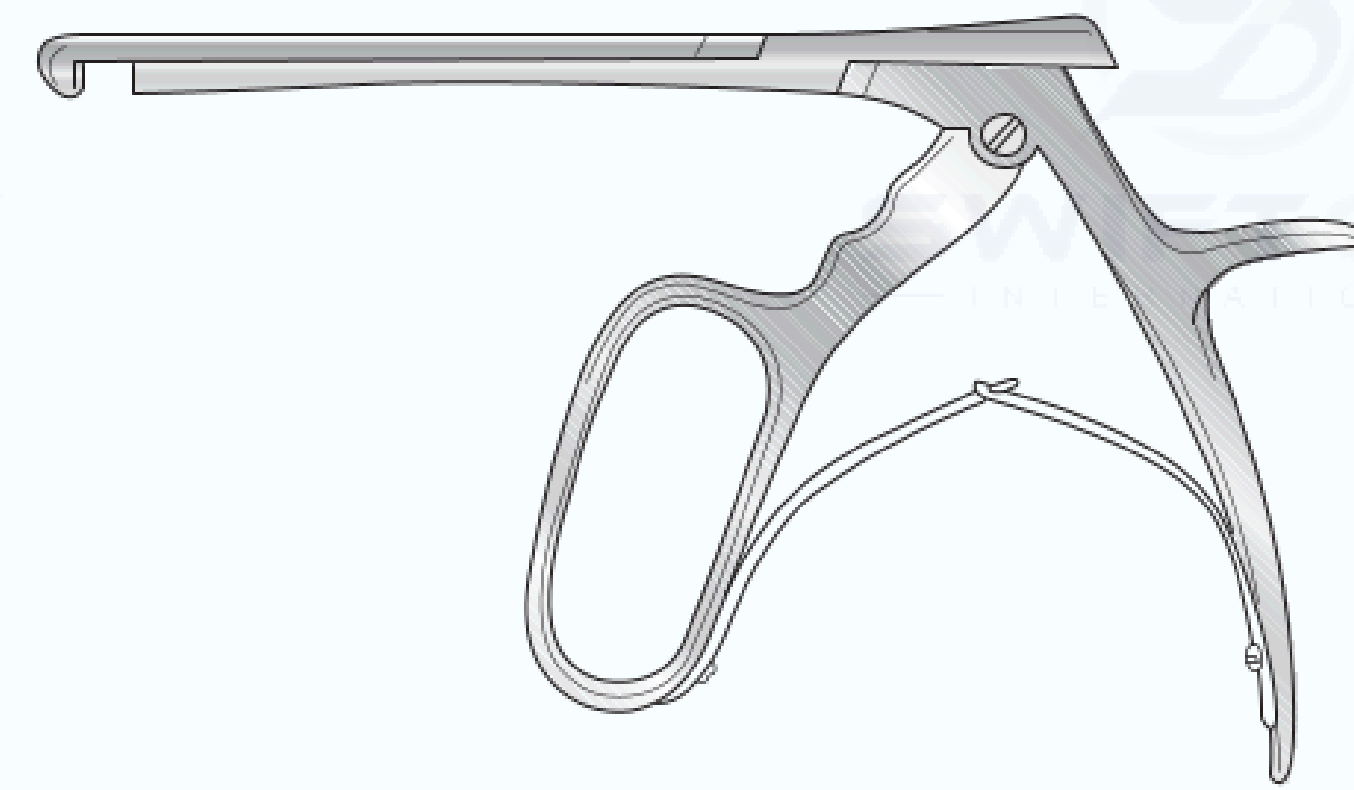

SC-ENT/137a	Upward cutting
SC-ENT/137B	Downward cutting

### Hajek Antrum Punch

197mm long

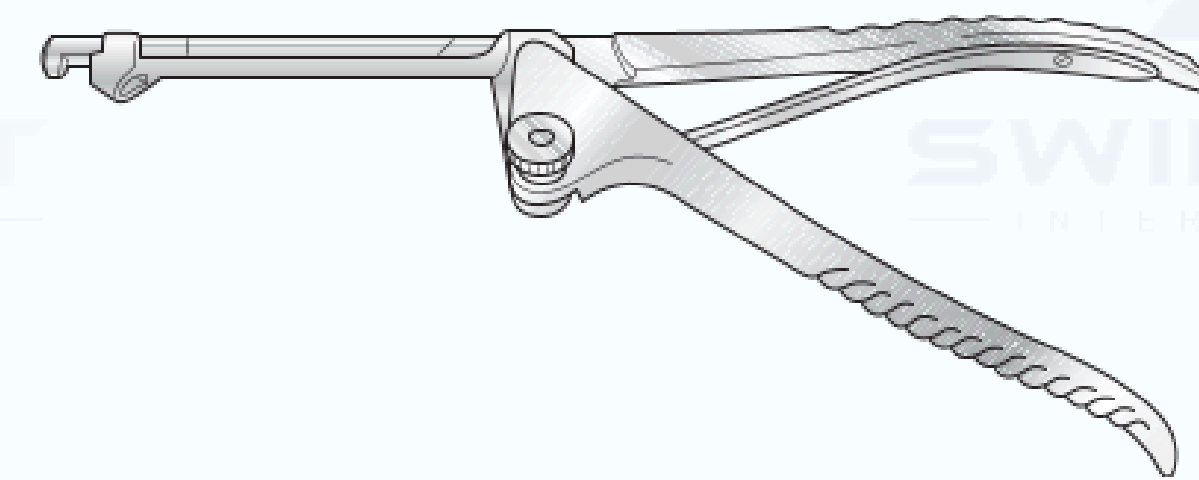

SC-ENT/134	5mm jaw
------------	---------

### Citelli Antrum Punch

76mm to shoulder



SC-ENT/133a	3mm jaw
SC-ENT/133b	5mm jaw

### Hajek Sphenoidal Punch

146mm to shoulder



#### Upward cutting

SC-ENT/141a	4mm bite
SC-ENT/141b	5mm bite

#### Downward cutting

SC-ENT/141c	4mm bite
SC-ENT/141d	5mm bite

### Beck Rongeur

Straight, for intervertebral disc

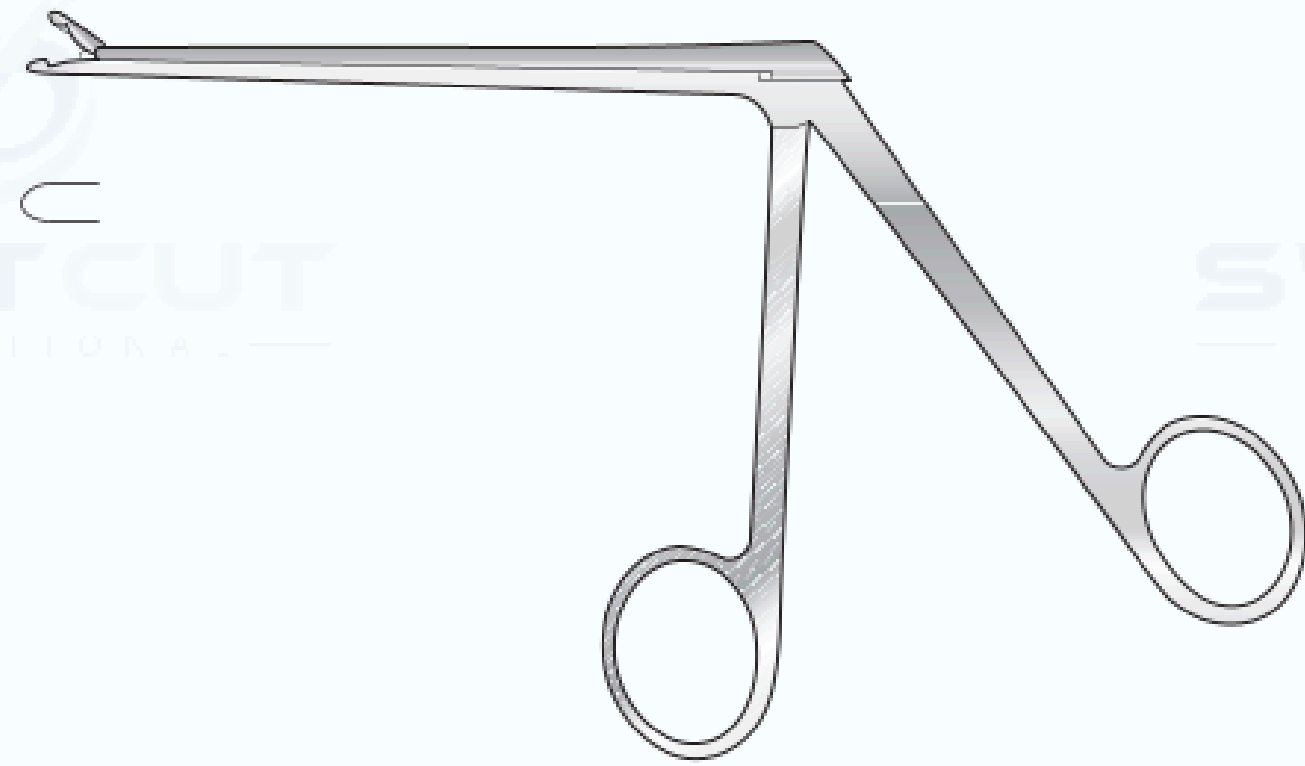

SC-NEU/125	2mm bite, 130mm shaft
------------	-----------------------

### Pennybacker Rongeur

120mm shaft

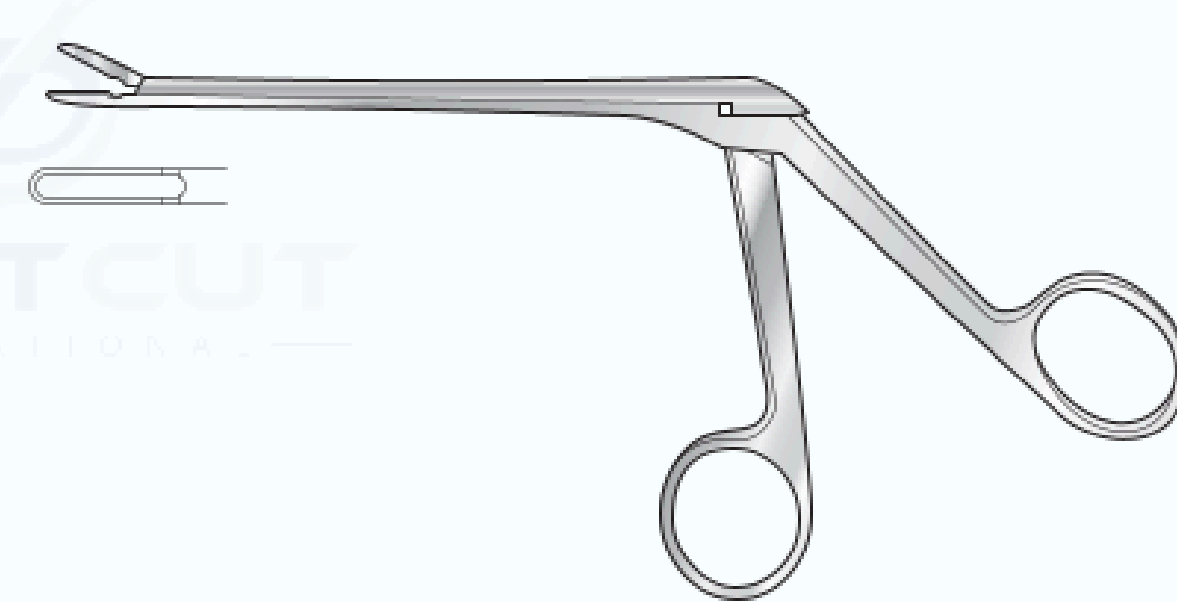

SC-NEU/133	3mm bite
SC-NEU/107	4mm bite

### Mackay Rongeur

140°, straight, 114mm shaft

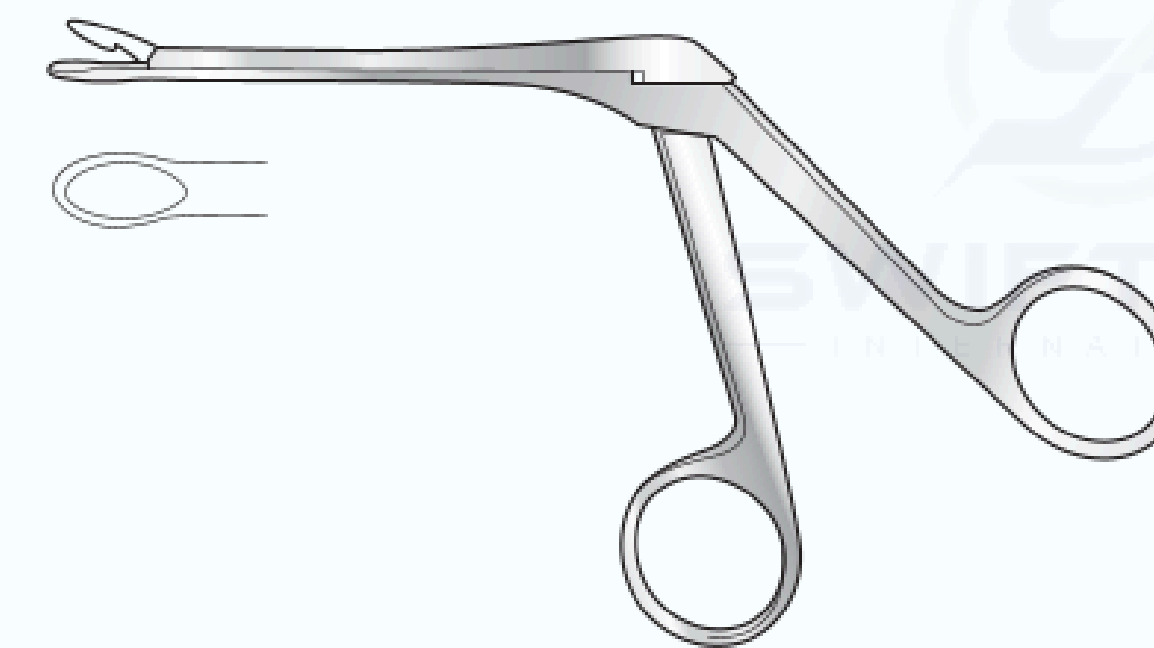

S C-S H /424 9	5.5mm
----------------	-------

### Weil-Blakesley Rongeur

110mm shaft

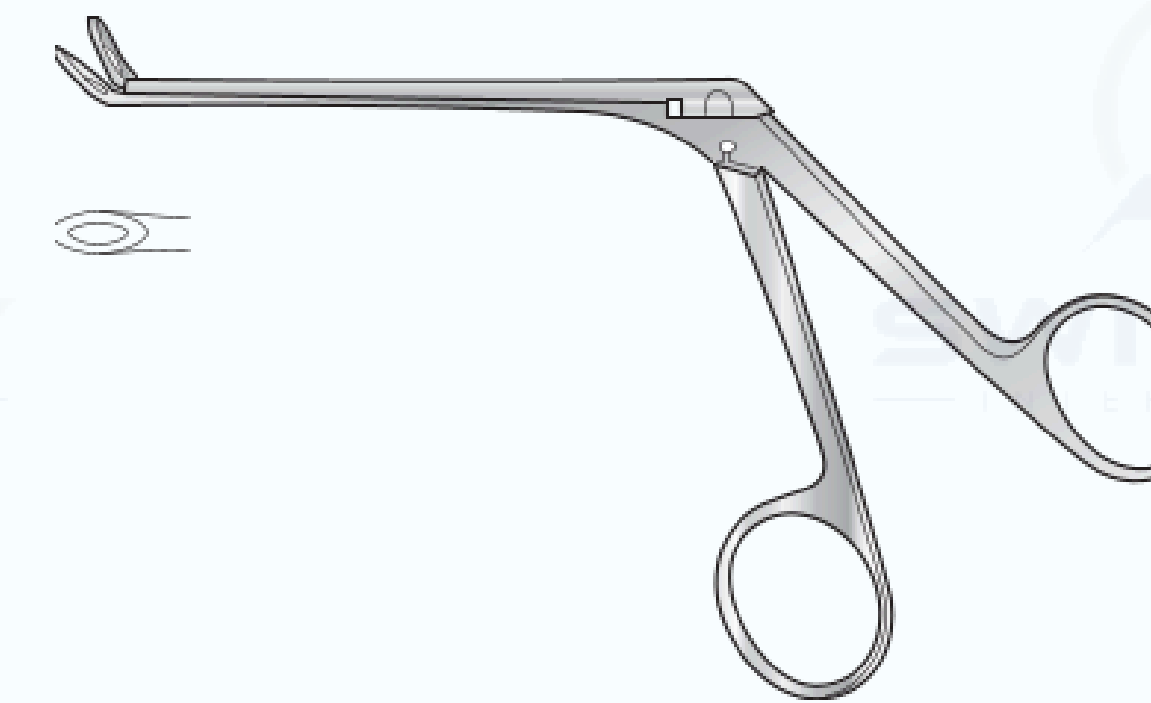

#### 140° upward cutting

SC-ENT/194b	3.6mm bite
SC-ENT/194e	4.2mm bite
SC-ENT/194f	4.8mm bite

#### 140° downward cutting

SC-ENT/194g	3.6mm bite
SC-ENT/194h	4.2mm bite
SC-ENT/194i	4.8mm bite

### Cushing Rongeur

130mm shaft



SC-NEU/127-2	2mm bite
SC-NEU/127-3	3mm bite
SC-NEU/127-4	4mm bite
SC-NEU/127-5	5mm bite
SC-NEU/127-6	6mm bite

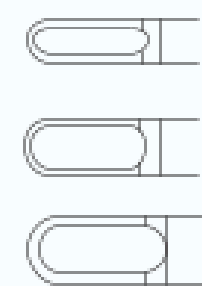

### St Bart's Rongeur

114mm shaft

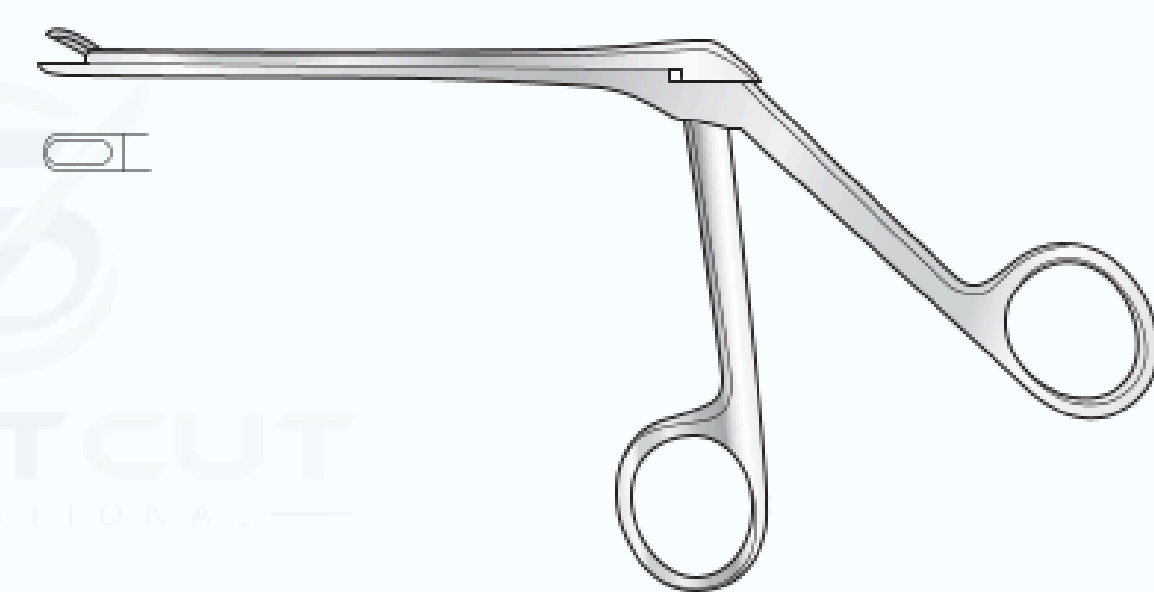

SC-ENT/140a	3mm bite
-------------	----------

### Mackay Rongeur

With suction tube

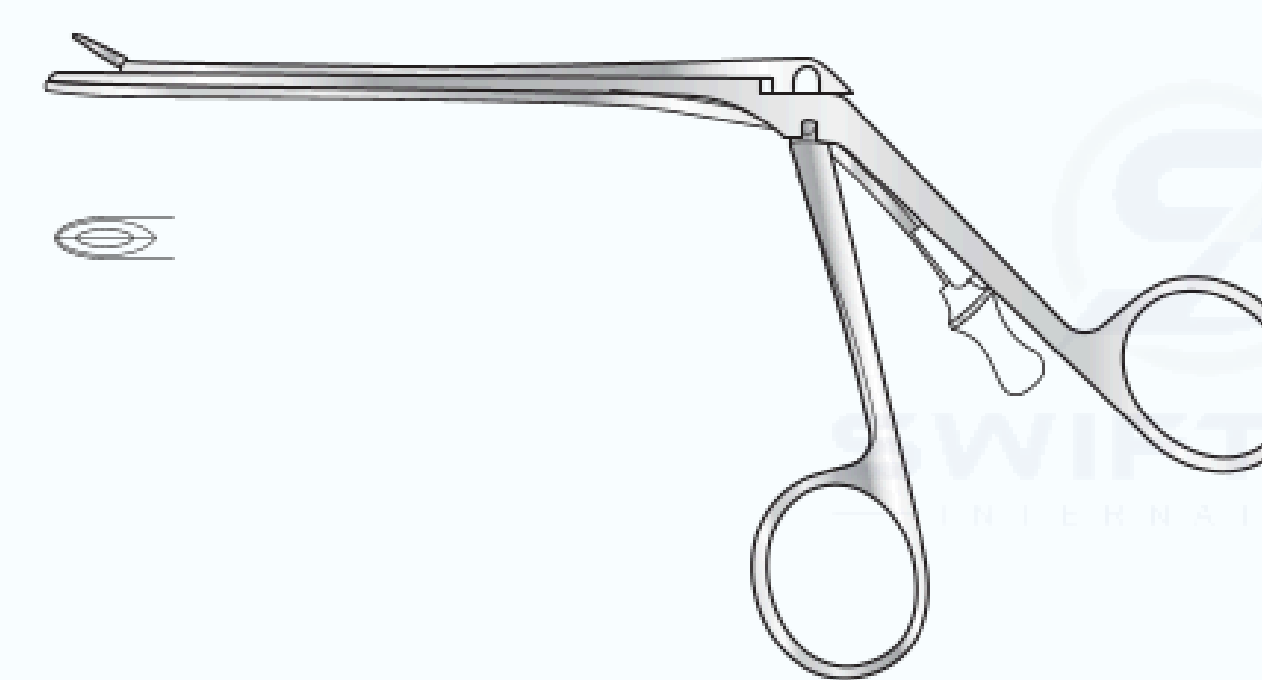

SC-SH/4249a	3.5mm bite, 114mm shaft
-------------	-------------------------

### Weil-Blakesley Rongeur

120mm shaft

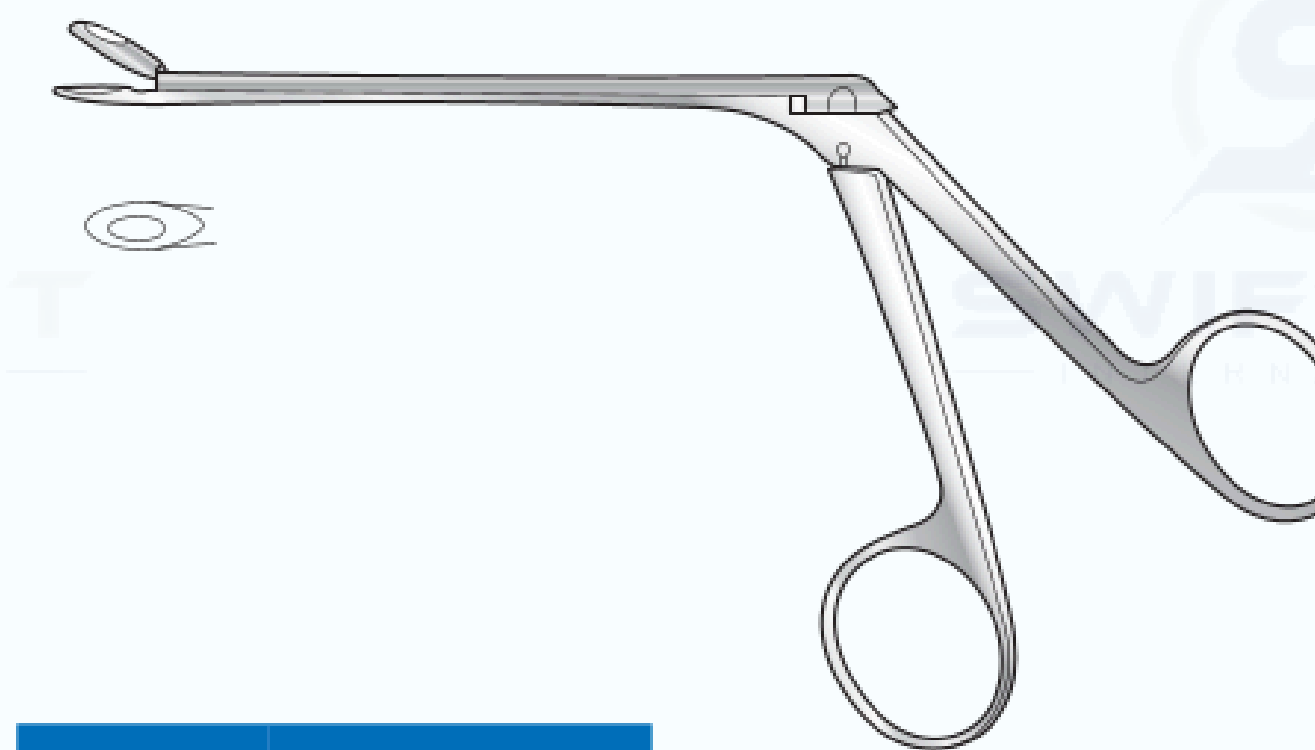

SC-ENT/193b	3.0mm bite
SC-ENT/193	3.6mm bite
SC-ENT/194	4.2mm bite
SC-ENT/194a	4.8mm bite
SC-ENT/194c	5.8mm bite
SC-ENT/194d	6.6mm bite

### Cushing Rongeur

130mm shaft

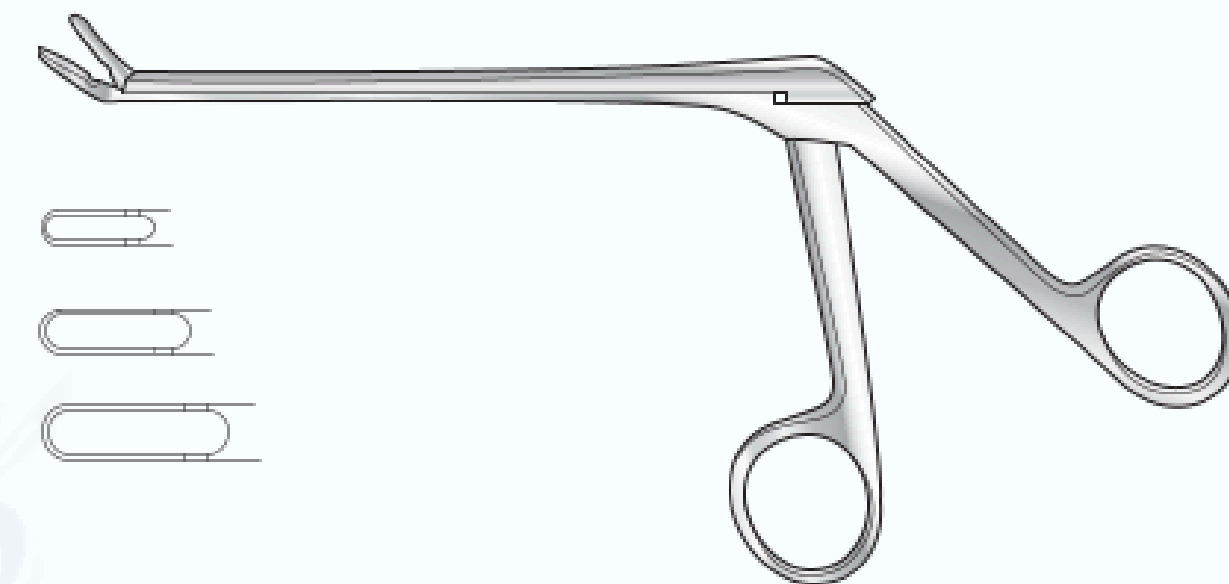

#### 150° upward cutting

SC-NEU/128c	2mm bite
SC-NEU/128	3mm bite
SC-NEU/128a	4mm bite
SC-NEU/128b	5mm bite

#### 150° downward cutting

SC-NEU/130c	2mm bite
SC-NEU/130	3mm bite
SC-NEU/130a	4mm bite
SC-NEU/130b	5mm bite

### St Bart's Rongeur

140°, 3mm, 114mm shaft

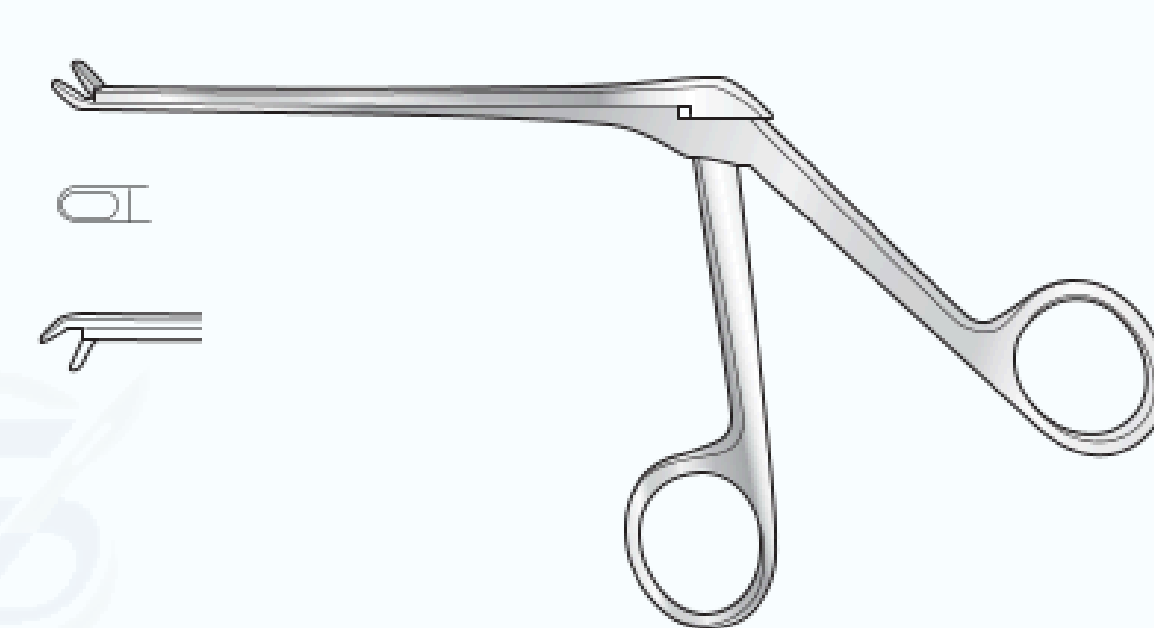

SC-ENT/140b	Upward cutting
SC-ENT/140ac	Downward cutting

### Mackay Rongeur

With suction tube, 140°upward cutting

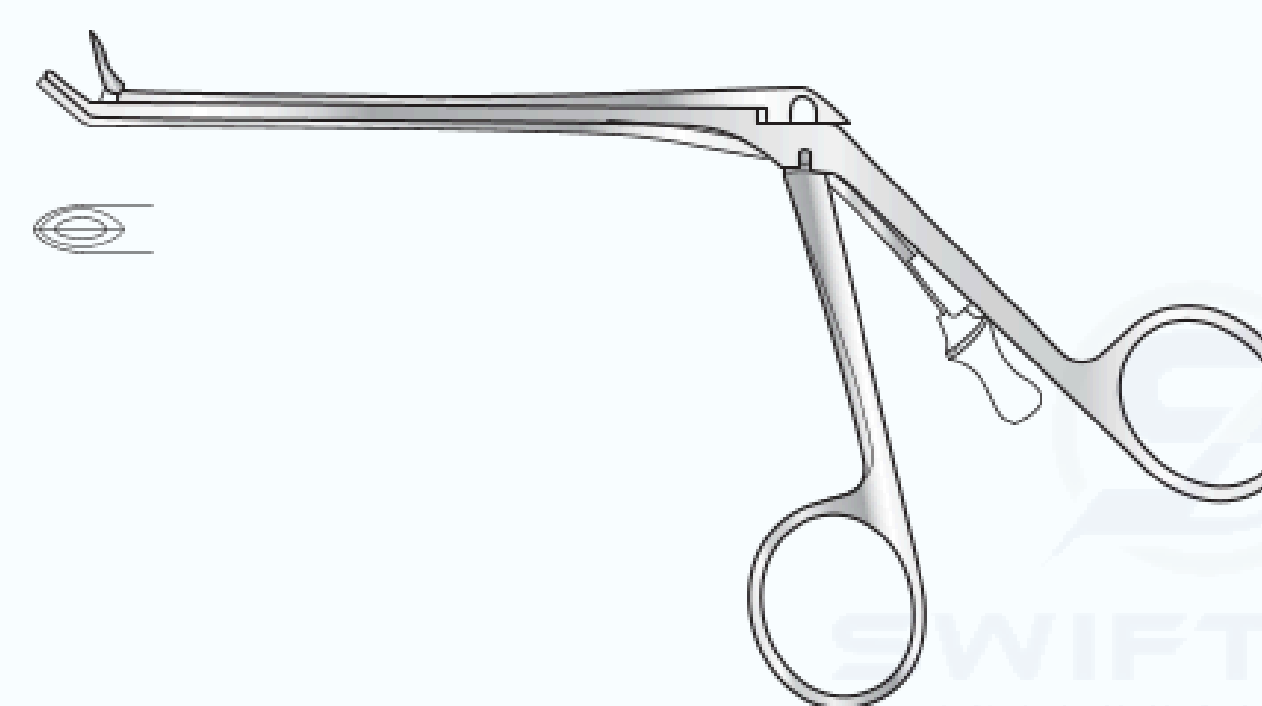

SC-SH/4249b	3.5mm bite, 114mm shaft
-------------	-------------------------

### Beckmann Turbinectomy Scissors

Curved



SC-ENT/097	165mm long
------------	------------

### Scott Stevenson Tonsil Scissors

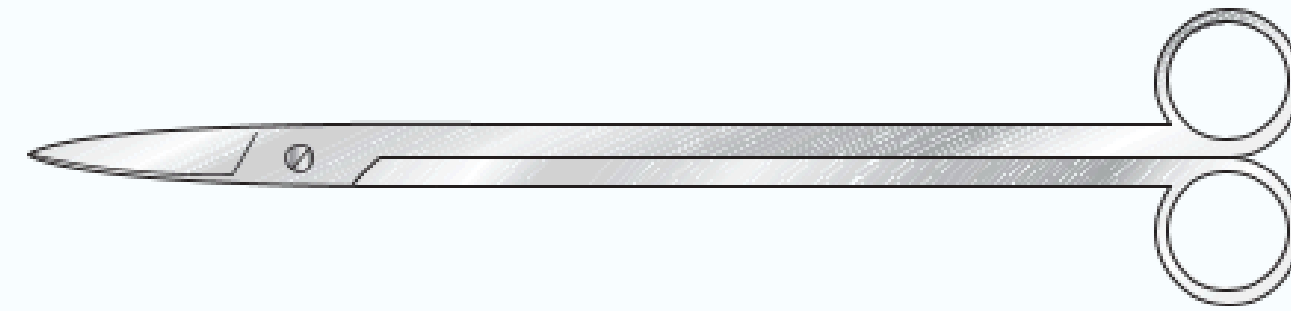

SC-ENT/159	216mm long
------------	------------

### Wood Tonsil Scissors

Sharpened outer edges



SC-ENT/156	178mm long
------------	------------

### Wheeler Tonsil Scissors

Triangular form blades, serrated shanks

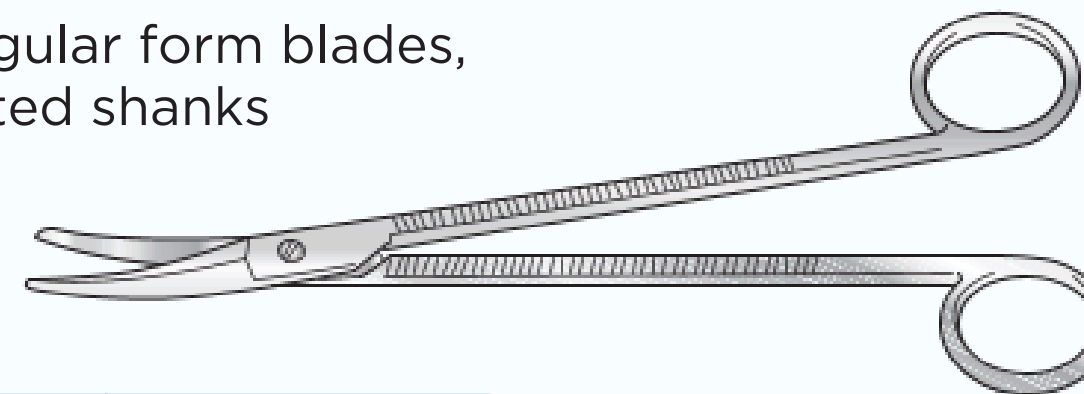

SC-ENT/157	184mm long
------------	------------

### Tilley Tonsil Scissors

Curved

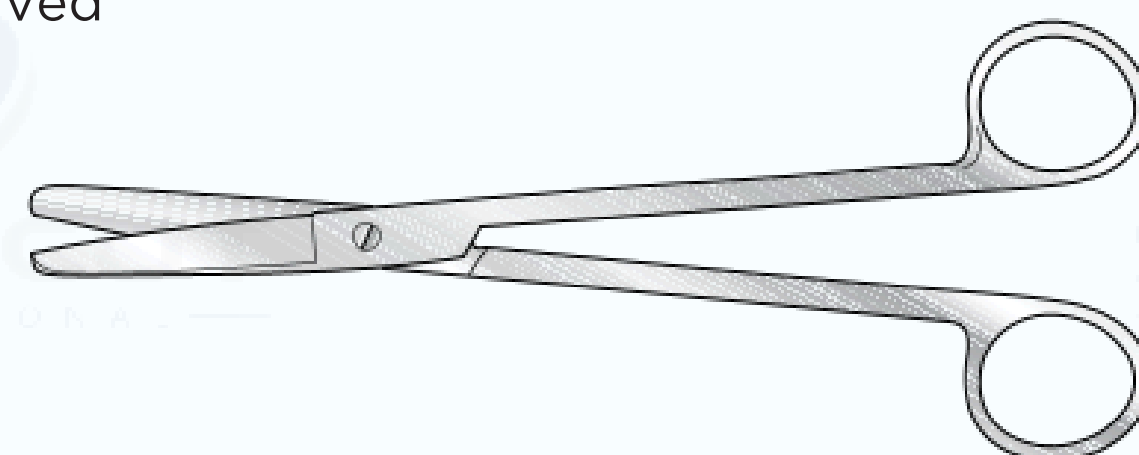

SC-ENT/158	190mm long
------------	------------

### Fomon Scissors

Straight, serrated blades, angled handles

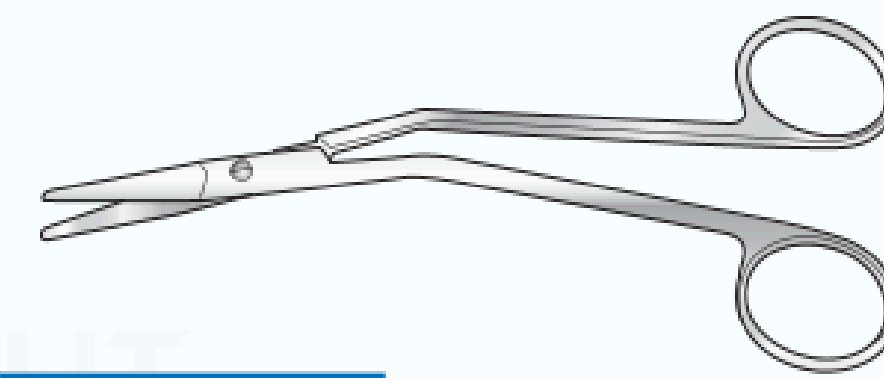

SC-ENT/200	145mm long
------------	------------

### Cottle Scissors

Straight blades, angled handles, blunt/blunt

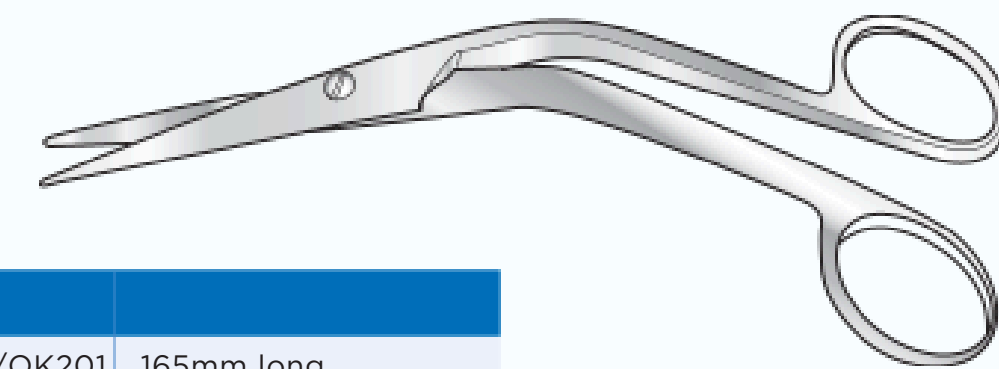

SC-ENT/OK201	165mm long
--------------	------------

### Cottle Bulldog Scissors

blunt, 115mm long

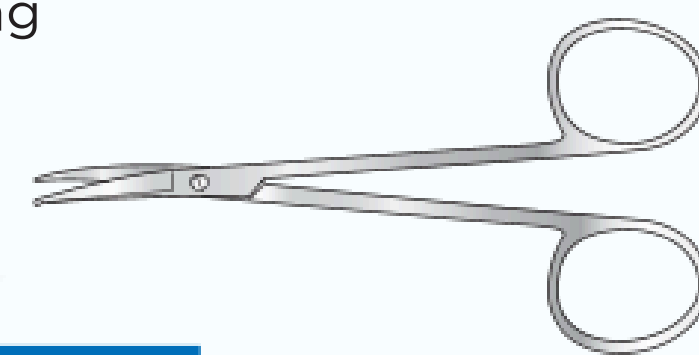

SC-ENT/202	115mm long
------------	------------

### Joseph Scissors

Sharp, 150mm long

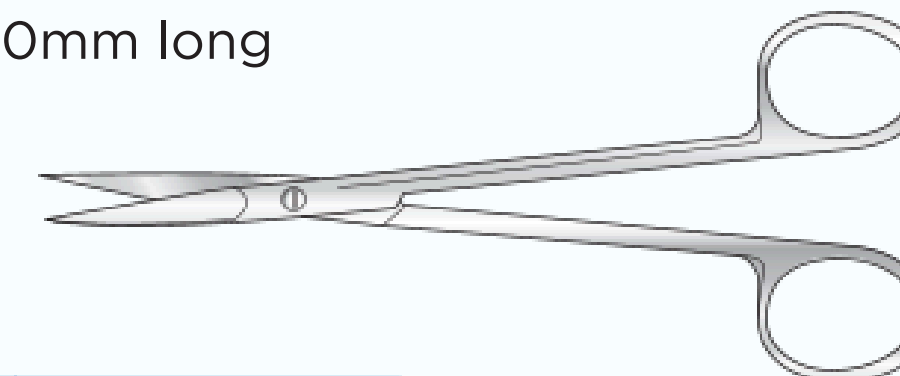

SC-ENT/203	Straight
SC-ENT/204	Curved

### Heymann Turbinectomy Scissors

Angular

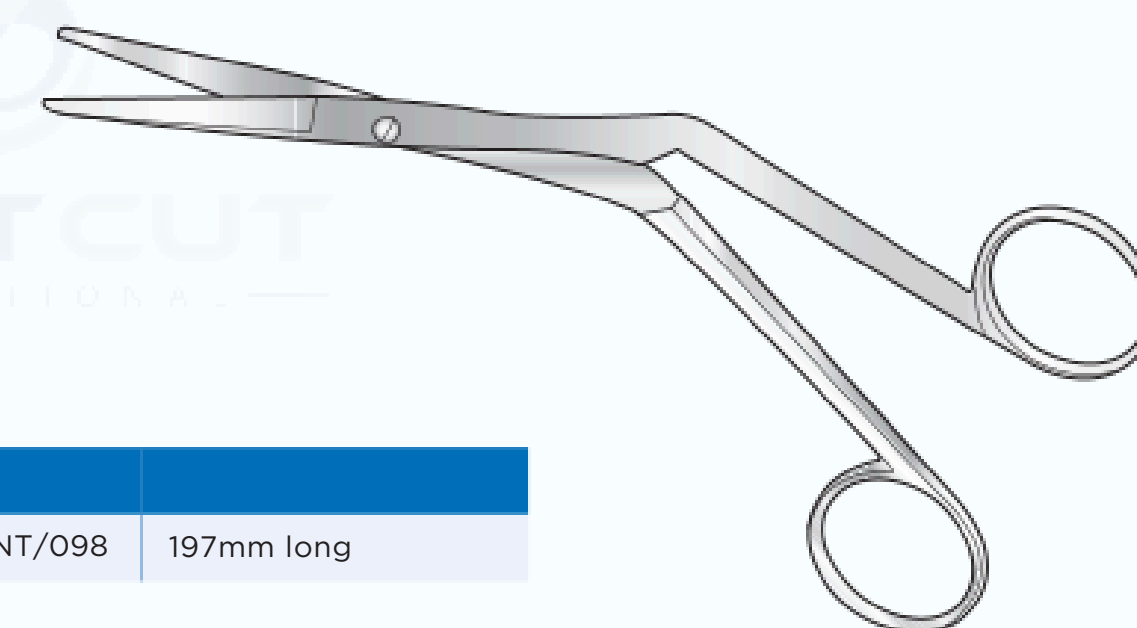

SC-ENT/098	197mm long
------------	------------

### Wilson Tonsil Scissors

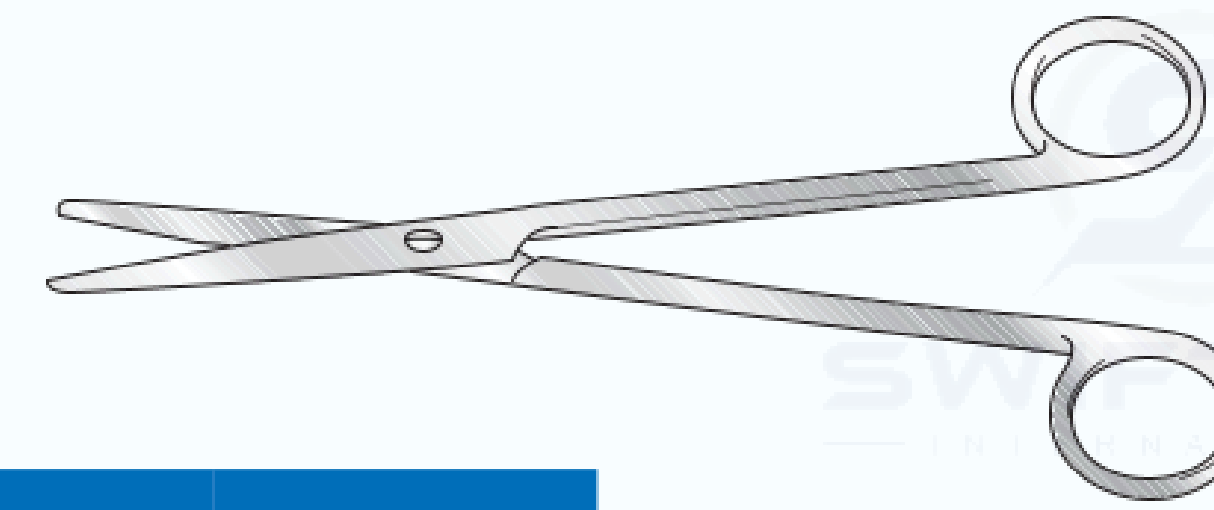

SC-ENT/160	203mm long
------------	------------

### Thyroid Scissors

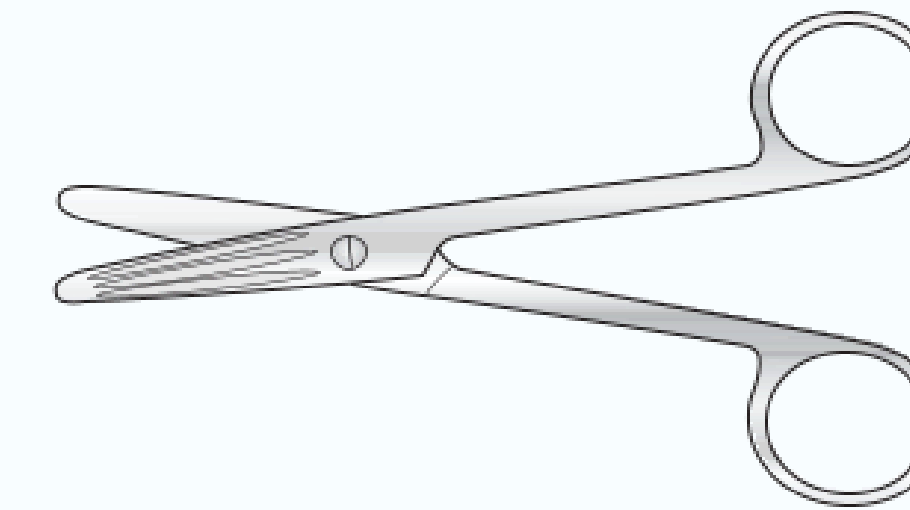

SC-ENT/171	152mm long
------------	------------

### Knapp Scissors

Slight curve, blunt points, 114mm long

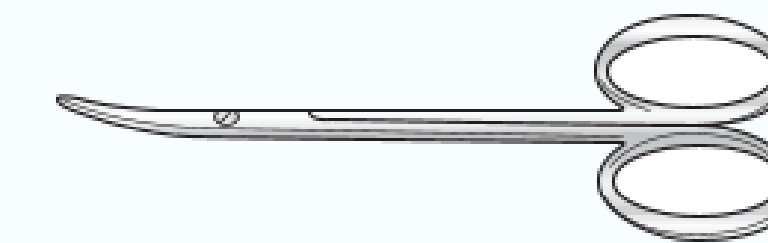

SC-ENT/187a	Satin finish
SC-ENT/187b	Black finish

### Cawthorne Scissors

Micro, extra fine, 70mm to shoulder

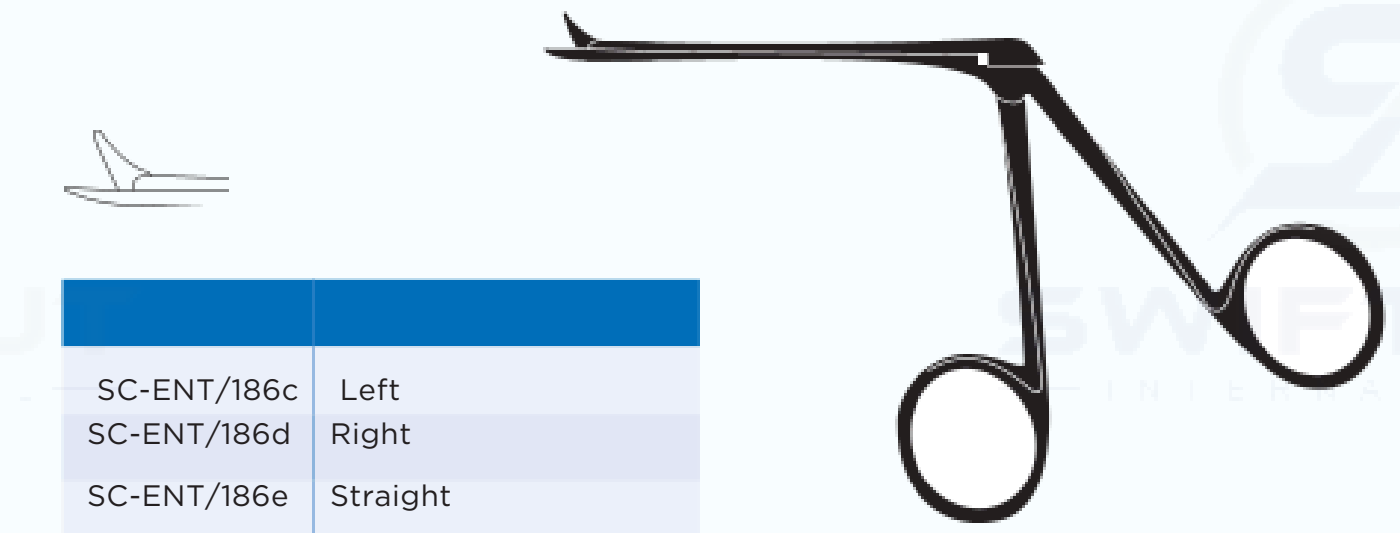

SC-ENT/186c	Left
SC-ENT/186d	Right
SC-ENT/186e	Straight

### Ormorod Aural Scissors

Micro, extra fine, curved upwards



SC-ENT/185	70mm to shoulder
------------	------------------

### Portmann Aural Scissors

Micro, satinfinish 70mm to shoulder

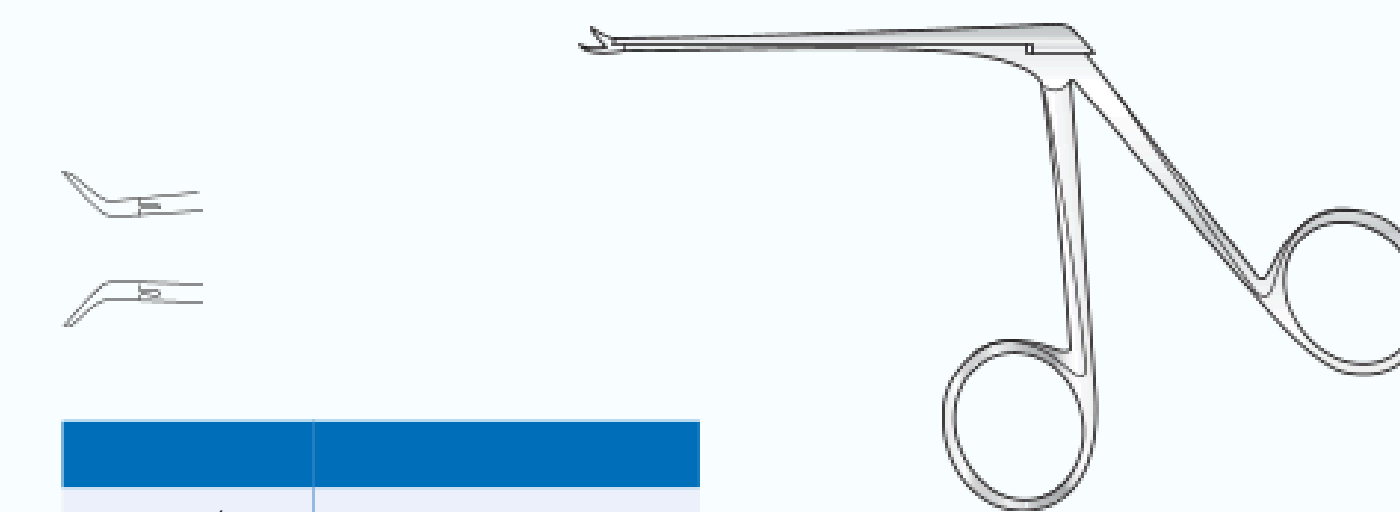

SC-ENT/186a	Curved to right
SC-ENT/186b	Curved to left

### Ballenger Nasal Cartilage Knife

Revolving blade

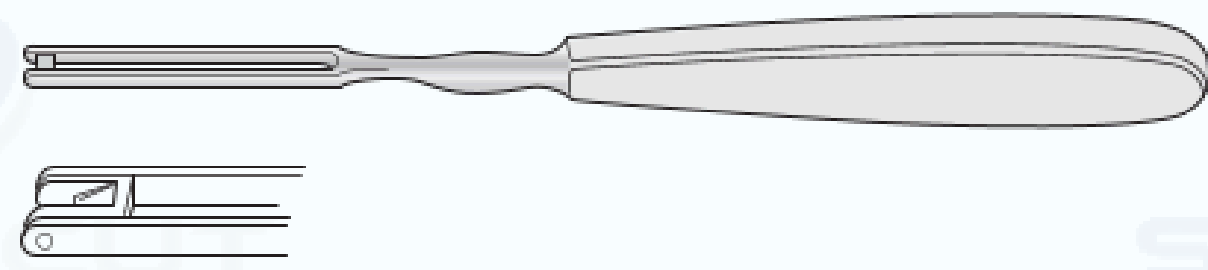

Straight, 203mm long

SC-ENT/096a	6mm wide
SC-ENT/096b	8mm wide

Cranked, 197mm long

SC-ENT/096c	6mm wide
-------------	----------

### Sickle Knife



SC-BUPNS002	188mm long
SC-ENT/271	160mm long

### Jenkins Gouge

140mm long



SC-ENT/037	1mm	SC-ENT/037g	8mm
SC-ENT/037a	2mm	SC-ENT/037h	9mm
SC-ENT/037b	3mm	SC-ENT/037i	10mm
SC-ENT/037c	4mm	SC-ENT/037j	11mm
SC-ENT/037d	5mm	SC-ENT/037k	12mm
SC-ENT/037e	6mm	SC-ENT/037l	13mm
SC-ENT/037f	7mm	SC-ENT/037m	14mm

### Killian Nasal Gouge

127mm long



SC-ENT/093	4mm
------------	-----

### Guy's Hospital Nasal Gouge

Shallow groove and flattened back, 127mm long

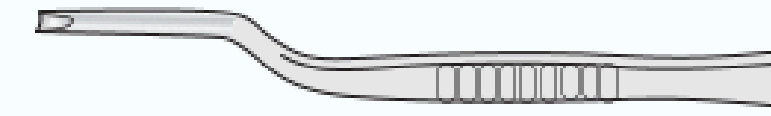

SC-ENT/094	4mm
------------	-----

### Tilley Nasal Gouge

V shaped, 127mm long



SC-ENT/095	4mm
------------	-----

### Cottle Elevator

Double ended, black chrome finish  
200mm long



SC-ENT/224
------------

### Hill Elevator

Double ended, curved to side, rugine end



SC-ENT/091	5mm wide, 222mm long
------------	----------------------

### Tumarkin Atticotomy Elevator

Double ended

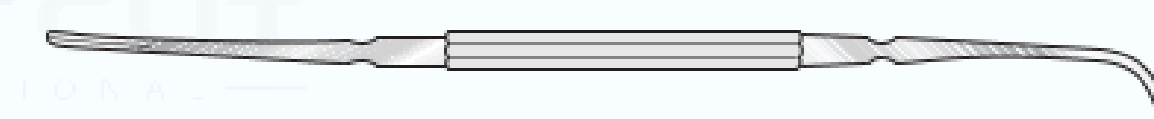

SC-ENT/036	191mm long
------------	------------

### Buck Ear Curette

Angled, blunt, 146mm long

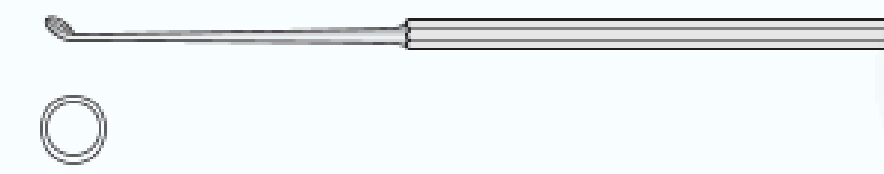

SC-ENT/028	2mm
SC-ENT/028a	2.5mm
SC-ENT/028b	3mm
SC-ENT/028c	3.5mm
SC-ENT/028d	4mm

### Beckmann Adenoid Curette

216mm long

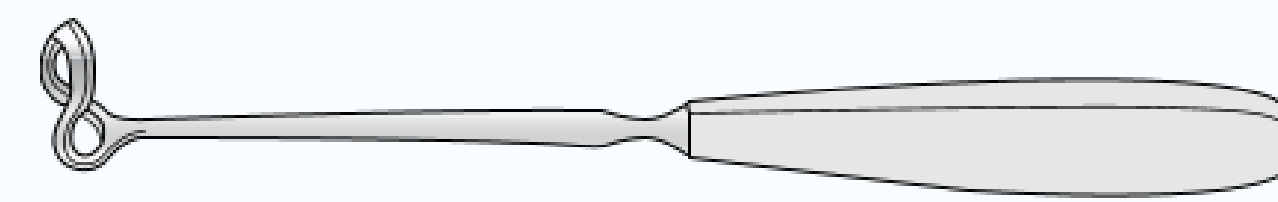

SC-ENT/167a	8mm blade
SC-ENT/167b	10mm blade
SC-ENT/167c	12mm blade
SC-ENT/167d	14mm blade
SC-ENT/167e	16mm blade
SC-ENT/167f	18mm blade

### St Clair Thomson Adenoid Curette

With cage, 235mm long

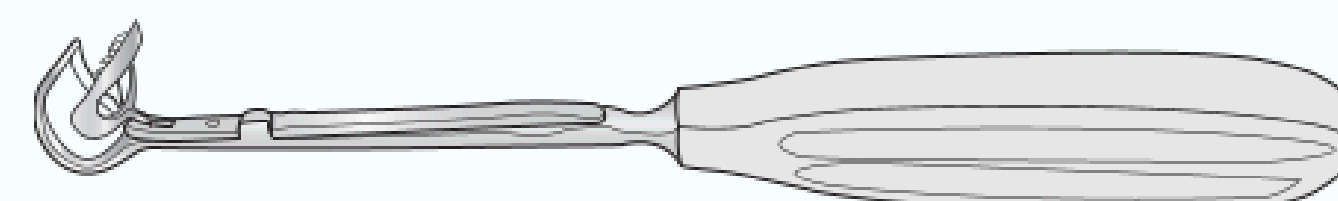

SC-ENT/168a	8mm
SC-ENT/168b	10mm
SC-ENT/168c	12mm
SC-ENT/168d	14mm
SC-ENT/168e	16mm
SC-ENT/168f	18mm

### Nasal Curette

Straight, 185mm long

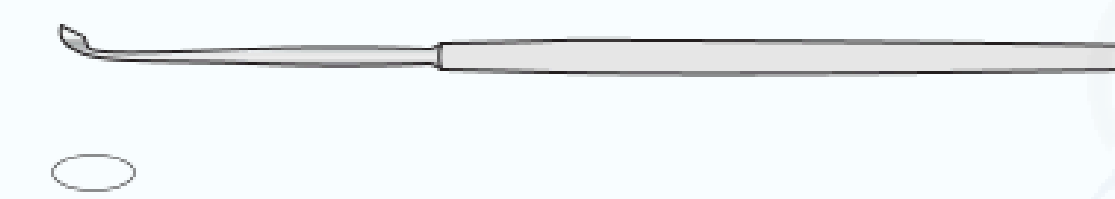

SC-ENT/628702	5 x 2mm
---------------	---------

### Agnew (Politzer) Myringotome

190mm long

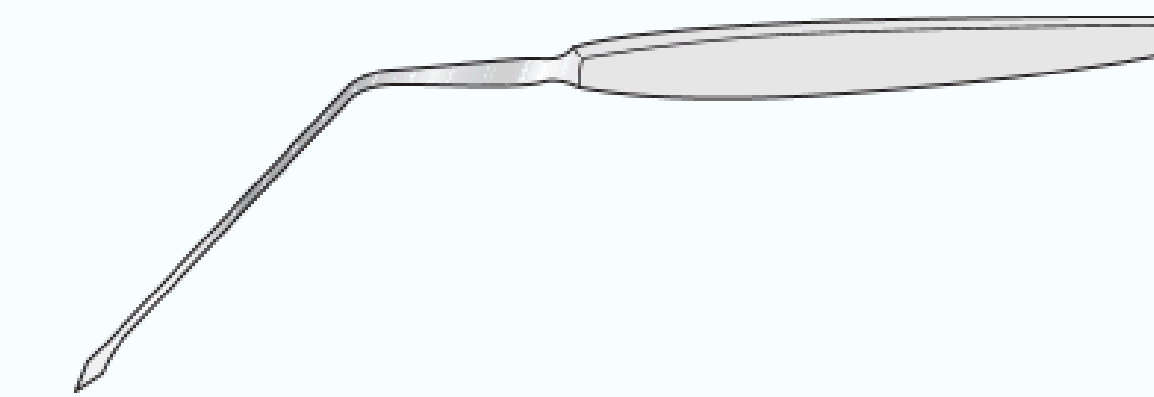

SC-ENT/031	Shaft length 100mm
------------	--------------------

### Trautmann Myringotome

178mm long



SC-ENT/032	Upward cutting
SC-ENT/033	Downward cutting

### Freer Instruments

Single ended, 190mm long

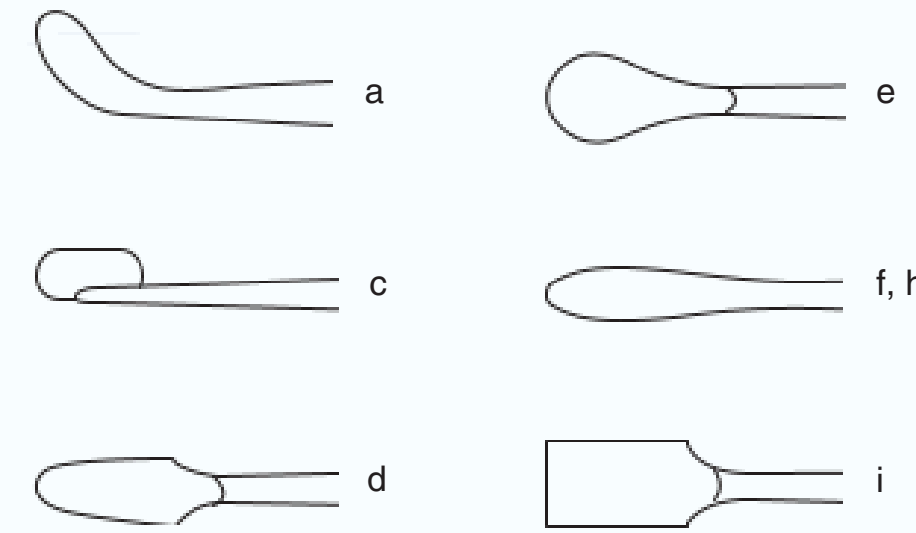

#### Knife

SC-ENT/065a	Curved to side
SC-ENT/065c	Rounded edge, 8mm blade
SC-ENT/065d	Flat rounded blade
SC-ENT/065e	Rounded blade, curved on flat

#### Elevator

SC-ENT/065f	Dull edged
SC-ENT/065h	Sharp edged

#### Chisel

SC-ENT/065i	
-------------	--

### Freer Separator and Elevator

Double ended

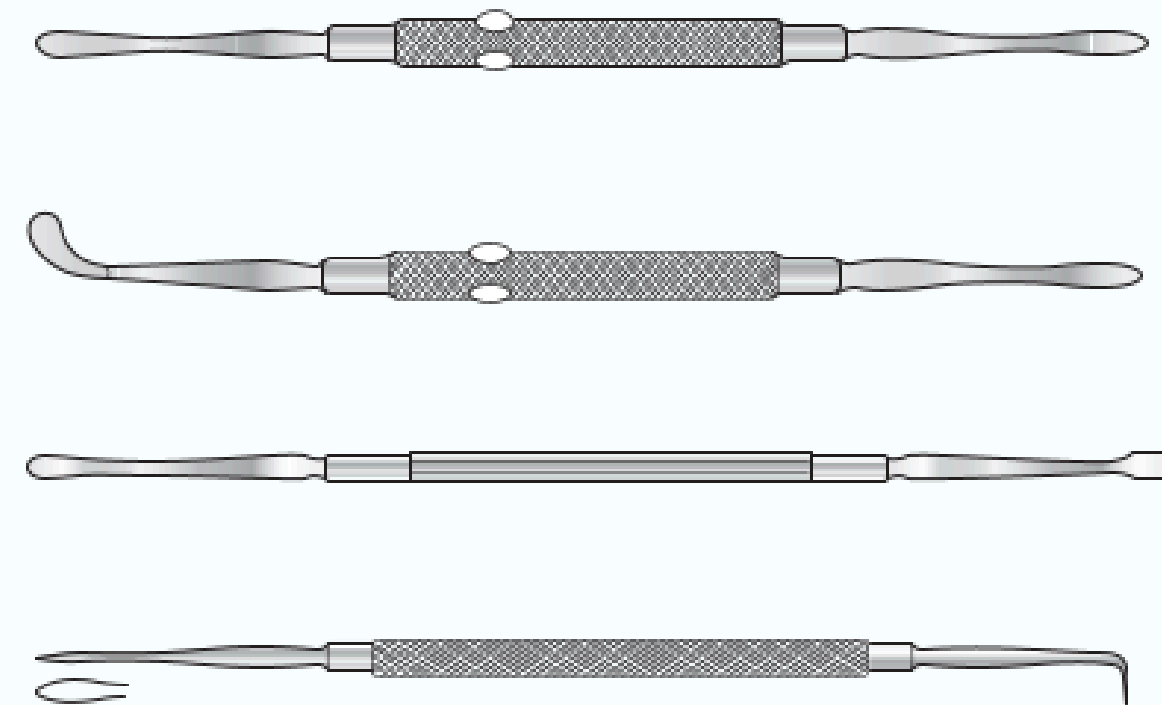

SC-ENT/065b	Blunt/sharp, 180mm long
SC-ENT/065g	Sharp, knife curved to side, 180mm long
SC-ENT/065j	Blunt/sharp, 200mm long
SC-ENT/065j-sal	Blunt/sharp, 188mm long

### St Clair Thompson Dissector

159mm

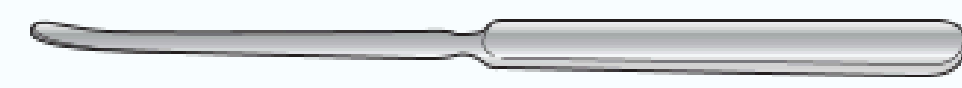

SC-ENT/089a	Sharp
SC-ENT/089b	Blunt

### Negus Aspiring Dissector

With 6mm olive, 210mm long

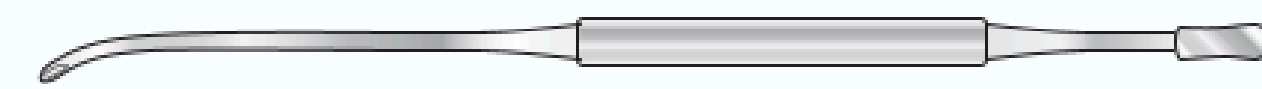

SC-ENT/090a	-
SC-ENT/090b	Insulated

### Syme Tonsil Dissector

Double ended, one end blunt, one semi sharp



SC-ENT/149	170mm long
------------	------------

### Gwynne-Evans Tonsil Dissector

Double ended, with serrated end and blunt end 197mm long



SC-ENT/146a	6mm wide
SC-ENT/146b	8mm wide

### Woakes Eustachian Catheters

Silver, Luer, 140mm

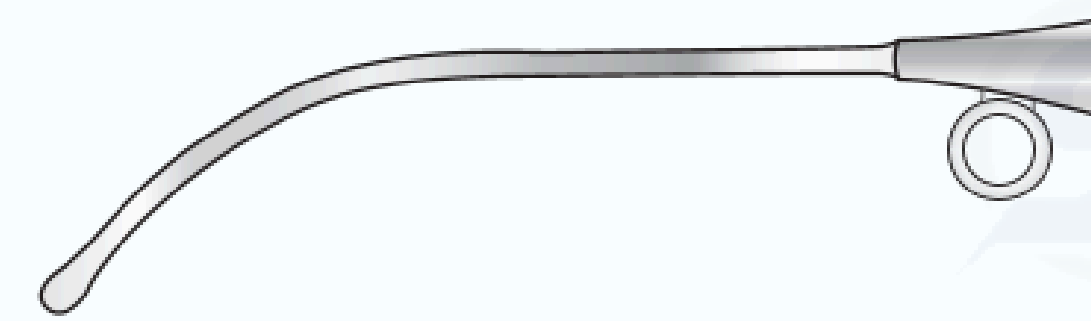

SC-ENT/015	7 F.G.	SC-ENT/015c	10 F.G.
SC-ENT/015a	8 F.G.	SC-ENT/015d	11 F.G.
SC-ENT/015b	9 F.G.		

### Kramer Eustachian Catheters

Silver, Luer, 140mm



SC-ENT/014	7 F.G.	SC-ENT/014c	10 F.G.
SC-ENT/014a	8 F.G.	SC-ENT/014d	11 F.G.
SC-ENT/014b	9 F.G.		

### Myles Naso-Antral Perforator

171 mm long

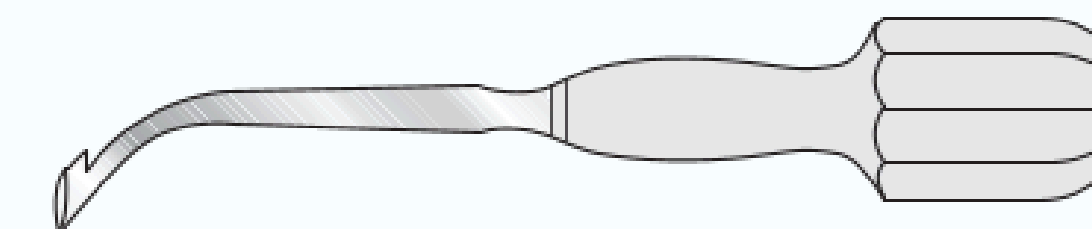

SC-ENT/103a	16 F.G.
SC-ENT/103b	19 F.G.

### Tilley Antrum Burrs

171mm long

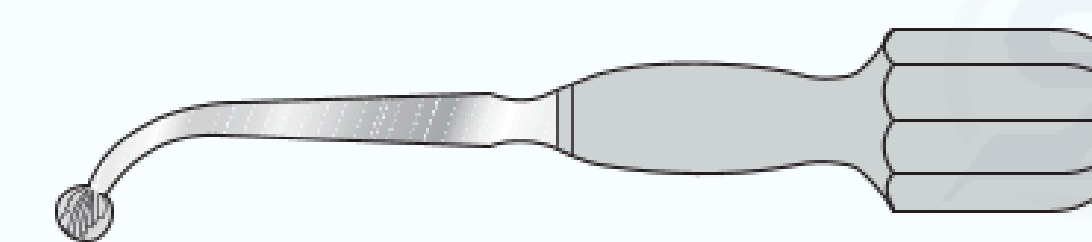

SC-ENT/131a	6mm ø
SC-ENT/131b	7mm ø
SC-ENT/131c	8mm ø

### Laryngeal Mirror

Mirror only, 130mm long

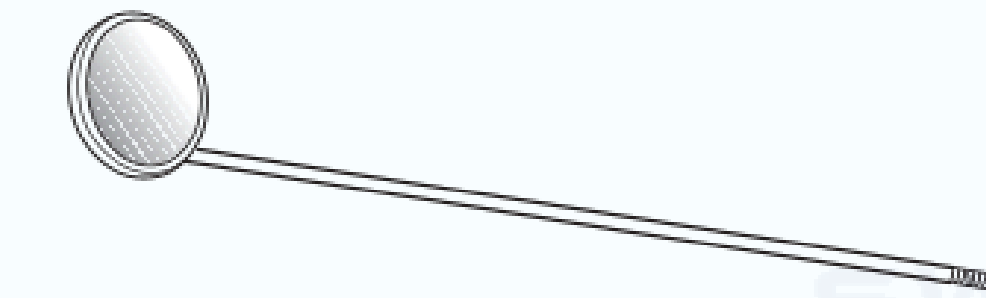

SC-ENT/191-6	6mm ø	SC-ENT/191-20	20mm ø
SC-ENT/191-8	8mm ø	SC-ENT/191-22	22mm ø
SC-ENT/191-10	10mm ø	SC-ENT/191-24	24mm ø
SC-ENT/191-12	12mm ø	SC-ENT/191-26	26mm ø
SC-ENT/191-14	14mm ø	SC-ENT/191-28	28mm ø
SC-ENT/191-16	16mm ø	SC-ENT/191-30	30mm ø
SC-ENT/191-18	18mm ø		

### Laryngeal Mirror

Complete with metal handle, 260mm long

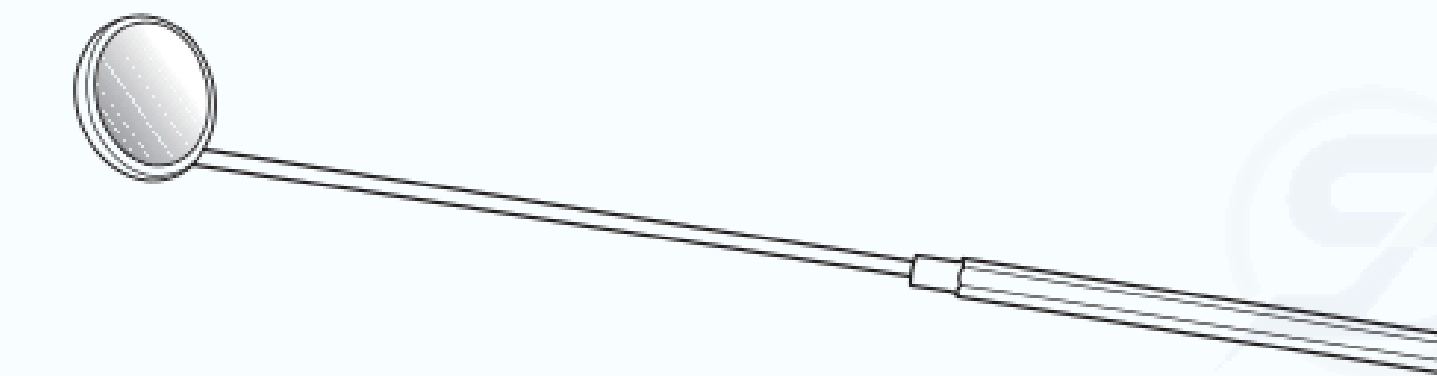

SC-ENT/192-6	6mm ø	SC-ENT/192-20	20mm ø
SC-ENT/192-8	8mm ø	SC-ENT/192-22	22mm ø
SC-ENT/192-10	10mm ø	SC-ENT/192-24	24mm ø
SC-ENT/192-12	12mm ø	SC-ENT/192-26	26mm ø
SC-ENT/192-14	14mm ø	SC-ENT/192-28	28mm ø
SC-ENT/192-16	16mm ø	SC-ENT/192-30	30mm ø
SC-ENT/192-18	18mm ø		

### Mitchell Trimmer



SC-ENT/013	165mm
------------	-------

### Quiver

With hole in end, 232mm long

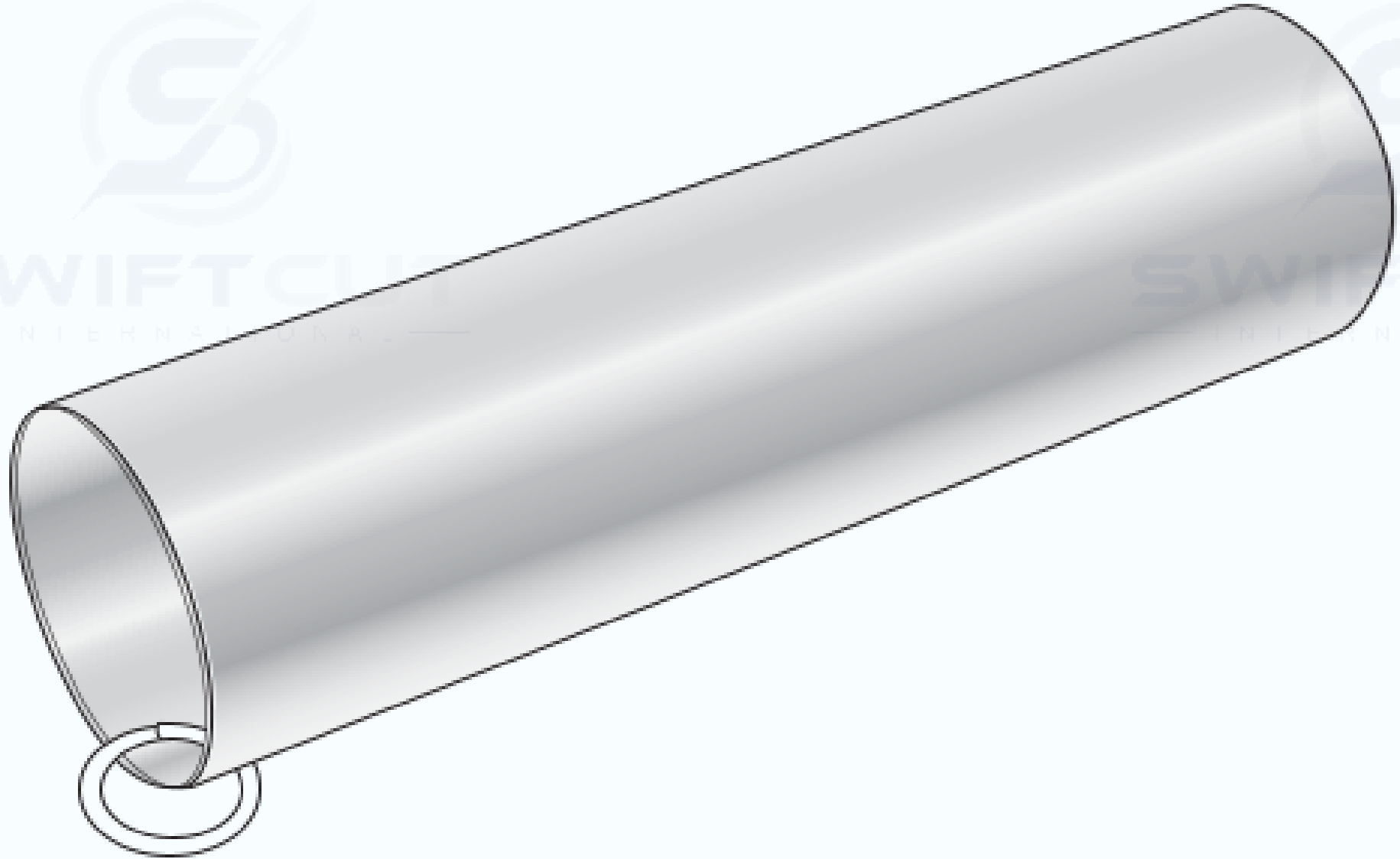

SC-DIA/001	Standard
------------	----------

### Quiver

With hole in end, 232mm long

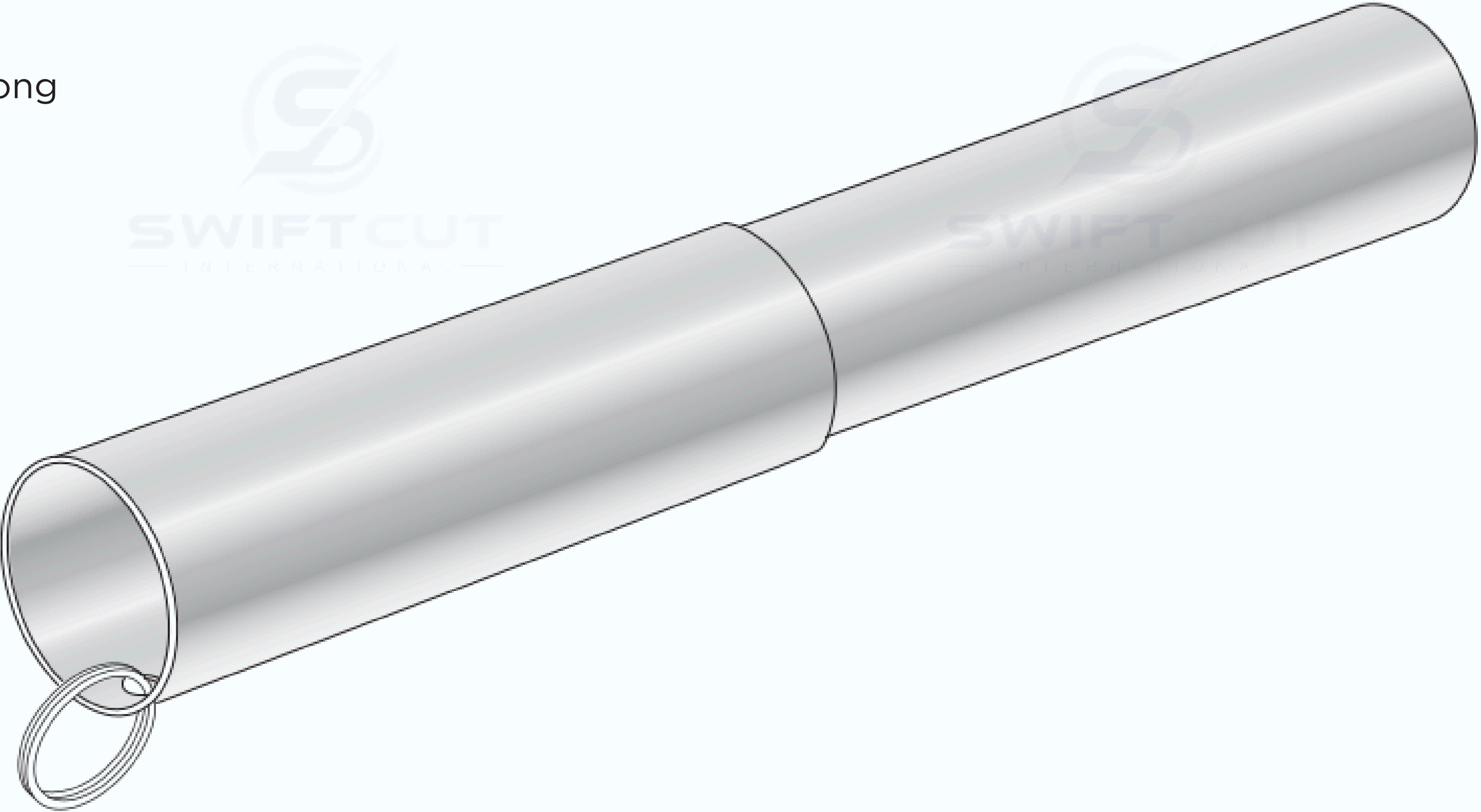

SC-DIA/002	Telescopic
------------	------------